

# DigitalFlow™ XGM868i

Panametrics General-Purpose Gas Flow Transmitter (1 & 2 Channel)

Programming Manual





# DigitalFlow™ XGM868i

## *Panametrics General-Purpose Gas Flow Transmitter (1 & 2 Channel)*

### Programming Manual

BH061C31 Rev. F  
Jul 2021

[panametrics.com](http://panametrics.com)

Copyright 2021 Baker Hughes company.

This material contains one or more registered trademarks of Baker Hughes Company and its subsidiaries in one or more countries. All third-party product and company names are trademarks of their respective holders.

[no content intended for this page]

---

## Information Paragraphs

*Note:* These paragraphs provide information that provides a deeper understanding of the situation, but is not essential to the proper completion of the instructions.

**IMPORTANT:** These paragraphs provide information emphasizing instructions which are essential to proper setup of the equipment. Failure to follow these instructions carefully may cause unreliable performance.



**WARNING!** Indicates a potentially hazardous situation which can result in serious personal injury or death, if it is not avoided.



**CAUTION!** Indicates a potentially hazardous situation which can result in minor or moderate injury to personnel or damage to the equipment, if it is not avoided.



**HIGH VOLTAGE!** This symbol indicates the presence of high voltage. It calls your attention to situations or operations that could be dangerous to you and other persons operating the equipment. Read these messages and follow the instructions carefully.

## Safety Issues



**WARNING!** It is the responsibility of the user to make sure all local, county, state and national codes, regulations, rules and laws related to safety and safe operating conditions are met for each installation.

## Auxiliary Equipment

### Local Safety Standards

The user must make sure that he operates all auxiliary equipment in accordance with local codes, standards, regulations, or laws applicable to safety.

### Working Area



**WARNING!** Auxiliary equipment may have both manual and automatic modes of operation. As equipment can move suddenly and without warning, do not enter the work cell of this equipment during automatic operation, and do not enter the work envelope of this equipment during manual operation. If you do, serious injury can result.



**WARNING!** Make sure that power to the auxiliary equipment is turned OFF and locked out before you perform maintenance procedures on the equipment.

### Qualification of Personnel

Make sure that all personnel have manufacturer-approved training applicable to the auxiliary equipment.

### Personal Safety Equipment

Make sure that operators and maintenance personnel have all safety equipment applicable to the auxiliary equipment. Examples include safety glasses, protective headgear, safety shoes, etc.

### Unauthorized Operation

Make sure that unauthorized personnel cannot gain access to the operation of the equipment.

### Environmental Compliance

#### Waste Electrical and Electronic Equipment (WEEE) Directive

Panametrics is an active participant in Europe's *Waste Electrical and Electronic Equipment (WEEE)* take-back initiative, directive 2012/19/EU.

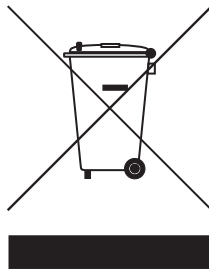

The equipment that you bought has required the extraction and use of natural resources for its production. It may contain hazardous substances that could impact health and the environment.

In order to avoid the dissemination of those substances in our environment and to diminish the pressure on the natural resources, we encourage you to use the appropriate take-back systems. Those systems will reuse or recycle most of the materials of your end life equipment in a sound way.

The crossed-out wheeled bin symbol invites you to use those systems.

If you need more information on the collection, reuse and recycling systems, please contact your local or regional waste administration.

Visit [www.bakerhughesds.com/health-safetyand-environment-hse](http://www.bakerhughesds.com/health-safetyand-environment-hse) for take-back instructions and more information about this initiative.

**Chapter 1. Programming Site Data**

1.1 Introduction .....1

1.2 Programming Methods ..... 2

1.3 The XGM868i Enclosure Keypad ..... 2

1.4 Activating a Channel ..... 4

1.5 Entering System Data for the Channel ..... 5

    1.5.1 Accessing the Channel-System Submenu ..... 5

    1.5.2 Selecting Volumetric Units ..... 5

    1.5.3 Selecting Totalizer Units ..... 5

    1.5.4 Selecting Mass Flow Units ..... 6

1.6 Entering Transducer and Pipe Parameters ..... 6

    1.6.1 Special Transducers ..... 6

    1.6.2 Pipe Data ..... 7

1.7 Entering Zero Cutoff and Setting Up Inputs ..... 9

    1.7.1 Zero Cutoff Value ..... 9

    1.7.2 Temperature Input ..... 9

    1.7.3 Base Temperature ..... 10

    1.7.4 Pressure Input ..... 10

    1.7.5 Base Pressure ..... 10

    1.7.6 Low Pressure Switch ..... 11

1.8 Entering Setup Data ..... 11

    1.8.1 Setting Transducer Signal Parameters ..... 11

    1.8.2 Initializing Setup Parameters - Default Setup ..... 14

    1.8.3 Setting Response Time - V Averaging ..... 14

    1.8.4 Using Advanced Features ..... 15

1.9 Entering Global Data ..... 17

    1.9.1 Entering Global System Data ..... 18

    1.9.2 Setting Up Inputs and Outputs ..... 20

    1.9.3 Configuring the Communications Port ..... 31

    1.9.4 Requesting Parameters Using MODBUS ..... 33

    1.9.5 Activating Security ..... 35

1.10 Exiting the User Program ..... 36

**Chapter 2. Displaying Data**

2.1 Introduction ..... 37

2.2 Displaying Data with the LCD ..... 37

    2.2.1 Adjusting LCD Contrast ..... 37

    2.2.2 Programming the LCD ..... 37

2.3 Displaying Data on a Computer Terminal ..... 39

    2.3.1 Preparing for PanaView Programming ..... 39

    2.3.1 The Text Display Output ..... 40

    2.3.2 The Graphing Output ..... 43

    2.3.3 Displaying Transducer Signals ..... 45

**Chapter 3. Logging Data**

3.1 Introduction ..... 49

3.2 Data Logging Option Card ..... 49

3.3 Logging with PanaView ..... 49

3.4 Creating Meter Logs ..... 49

    3.4.1 Creating a Standard Meter Log ..... 50

    3.4.2 Creating an Error Log ..... 52

3.5 Creating PC Logs ..... 54

3.6 Viewing Meter Log Files ..... 57

3.7 Viewing PC Log Files ..... 59

**Chapter 4. Printing Data**

4.1 Data Types for Printing ..... 61

**Chapter 5. Clearing Data**

5.1 Introduction..... 63

5.2 Clearing the XGM868i’s Memory..... 63

    5.2.1 Clearing Site Data..... 63

    5.2.2 Clearing Log Files..... 64

    5.2.3 Clearing the Totalizers..... 65

**Appendix A. Menu Maps**

**Appendix B. Data Records**

B.1 Available Option Cards..... 73

B.2 Option Cards Installed..... 74

B.3 Setup Data..... 75

**Appendix C. Programming the XGM868i Using PanaView™**

C.1 Introduction..... 79

C.2 Programming Using PanaView™..... 79

    C.2.1 Preparing for PanaView Programming..... 79

    C.2.2 Setting Up the Communications Port..... 80

    C.2.3 Setting up Ethernet Communications..... 82

    C.2.4 Modifying Ethernet Parameters..... 83

C.3 Adding the XGM868i..... 84

C.4 Entering the User Program Using PanaView..... 86

C.5 Entering Data in the Channel Menu..... 89

    C.5.1 Selecting the Channel Measurement Method..... 89

    C.5.2 Entering Data in the Channel System Option..... 90

    C.5.3 Entering Pipe Parameters..... 92

    C.5.4 Entering Input/Output Parameters..... 94

    C.5.5 Entering Setup Parameters..... 96

C.6 Entering Data in the Global Menu..... 102

    C.6.1 Entering Global-System Data..... 103

    C.6.2 Setting Up Inputs and Outputs..... 105

    C.6.3 Entering Communications Data..... 117

C.7 Exiting the Site Edit Menu..... 122

C.8 Saving Site Data..... 123

    C.8.1 Saving Current Site Data to the Meter..... 124

    C.8.2 Saving New Site Data to the XGM868i..... 125

    C.8.3 Saving a Site to the PC..... 125

    C.8.4 Clearing a Site from the Meter..... 126

    C.8.5 Saving Site Data in Text Form..... 126

**Appendix D. PanaView Menu Maps for the XGM868i**

**Appendix E. Foundation Fieldbus Communications**

E.1 Introduction..... 133

E.2 Configuration Utility Setup..... 134

E.3 Selecting the Desired Measurements..... 134

E.1 Selecting Units for AI Blocks..... 136

E.1 Resetting Instrument Totalizers..... 137

E.1 Function Block Application..... 138

**Appendix F. Foundation Fieldbus Tables**



# Chapter 1. Programming Site Data

## 1.1 Introduction

The Model XGM868i flow transmitter must be properly installed and programmed, as described in the *Startup Guide*, before it can provide accurate flow rate measurements. After completing the installation and initial setup, use this chapter to program the advanced features of the Model XGM868i's *Keypad Program*.

Step-by-step programming instructions are presented in this chapter. Also, as a programming aid, a complete set of menu maps for the **XGM868i** are included in Appendix A, *Menu Maps*. The specific figure numbers will be referenced throughout this chapter, as required.

Refer to the appropriate section for a discussion of the following *Keypad Program* features.

- **Channelx-ACTIV** - activate one or both channels and Scroll to the desired measurement method.
- **Channelx-SYSTM** - enter the individual channel parameters.
- **Channelx-PIPE** - enter the pipe geometry and other parameters.
- **Channelx-I/O** - set up the inputs and outputs.
- **Channelx-SETUP** - set the signal limits, response times and mass flow status.
- **Global-SYSTM** - scroll to system units (English or metric).
- **Global-I/O** - set up error handling, option cards and the display.
- **Global-COMM** - set the serial port parameters.

**Note:** The "x" in CHx represents the channel number. If you are using a 1-Channel meter, only CH1 will appear.

To get the XGM868i up and running as quickly as possible you must, as a minimum, activate the channel(s), enter the channel and global system data and the pipe parameters. The *Procedure Options* section at the end of each menu will help you in programming the required (quick startup) and optional data.

**Note:** In this manual, only the programming of Channel 1 will be described. To program Channel 2 of a 2-channel meter, simply repeat the same procedure presented for Channel 1.

## 1.2 Programming Methods

You can program the XGM868i via either the keypad on the lower part of the glass enclosure, or **PanaView™**, a PC-based, non-resident software program that communicates with the XGM868i via its RS232 serial port. PanaView supplements basic XGM868i functions with several additional capabilities. With PanaView, you can:

- load and save site file data
- create and save graph and log files
- display text output and graphs of live measurement data
- create custom templates for displaying text, graph and log data
- interface with multiple Panametrics instruments.

Although the actual displays differ somewhat, the general procedures are the same for all three programming methods. This chapter provides detailed programming instructions for use with the keypad. If you are using PanaView™, see Appendix C, *Programming the XGM868i via PanaView™*, and/or the *PanaView™ User's Manual* (910–211) for detailed instructions.

**IMPORTANT:** This manual is for instruments using software version Y4AM or later.

## 1.3 The XGM868i Enclosure Keypad

### Keypad Program

Along with the 2-line, 16-character LCD, the XGM868i includes a 6-key magnetic keypad. The decal cutout for each key contains a hall effect sensor, pushbutton switch and visible red LED. The magnetic wand used to activate a magnetic key is found attached to the meter chassis below the front panel. An operator activates the key by pressing the magnetic wand up to the glass lid over the desired key. The LED will light indicating a successful key press.

**Note:** *The pushbutton switch will also act as a key press but is done with the glass lid open. Do not use the pushbutton switch in a hazardous area where the lid needs to be installed.*

Use the magnetic keypad to navigate through the user program. The menu map may be followed in sequence, or the four arrow keys may be used to scroll through the prompt screens. Figure 1 shows the front of the XGM868i, with magnetic keypad and magnetic wand.

### 1.3 The XGM868i Enclosure Keypad (cont.)

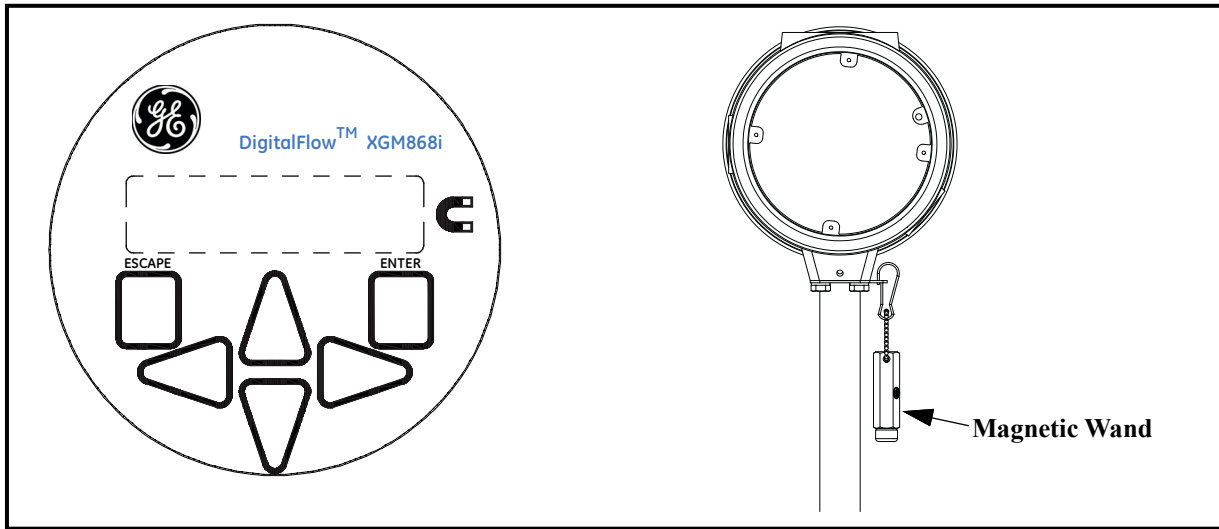

**Figure 1: XGM868i Magnetic Keypad and Wand**

**IMPORTANT:** The XGM868i's keypad enables programming of the instrument through the glass faceplate without removing the cover. Thus, all programming procedures may be performed while the unit is installed in a hazardous area.

Six keys on the keypad enable users to program the XGM868i:

- [Enter] - confirms choice of a specific option and data entry within the option
- [Escape] - allows users to exit from a specific option without entering unconfirmed data
- [△] and [▽] - enable users to highlight a specific window in the display option or to scroll through a list of options (parameters, letters, and numbers 0-9 as well as the negative sign and decimal point) in a menu
- [◀] and [▶] - enable users to scroll to a specific option, among choices in an option, or to a character in a text entry.

When you power up the XGM868i, the display first shows the model and software version:

Panametrics XGM868i Y4AM.STD
---------------------------------

The meter then starts to display measured parameters.

CH1	VEL	E1
	10.00	Ft/s

To enter the *Keypad Program*, press the [Escape] key, followed by the [Enter] key, and the [Escape] key again. Each successive key must be entered within 10 seconds of the prior key.

## 1.3 The XGM868i Enclosure Keypad (cont.)

As a guide in following the programming instructions in this chapter, the relevant portions of the Model XGM868i menu map have been reproduced in Figure 28 on page 69 and Figure 29 on page 70. Proceed to the following sections to enter data in the Channel or GLOBL menus.

**IMPORTANT:** If the keypad has not been pressed for 10 minutes, the XGM868i exits the Keypad Program and returns to displaying measurements. The meter retains any configuration changes that were confirmed with the [Enter] key, and restarts as if the operator had completed the programming cycle.

## 1.4 Activating a Channel

The **Channelx-ACTIV** submenu permits selection of the desired measurement method. In addition, it is used to activate/deactivate one or both of the channels in a 2-Channel Model XGM868i.

While following the programming instructions, refer to Figure 28 on page 69. To access the Channelx-ACTIV submenu:

1. In the *Keypad Program*, scroll to PROG and press [Enter].
  2. In the PROG menu, scroll to CH1 or CH2 and press [Enter].
  3. In the Channel PROGRAM menu, scroll to ACTIV and press [Enter].
  4. Scroll to *Burst* to activate the channel/path, and press [Enter].
- Note:** *Burst is automatically selected for a 1-Channel meter.*
5. Scroll to one of the measurement methods described below and press [Enter].

- Skan Only is the preferred technique for locating the acoustic signal and for high velocity measurements. It is more robust in a noisy environment than the Measure technique.
- Skan/Measure is the preferred technique to use for low velocity measurements.

If Skan Only is selected at the above prompt, the meter uses this technique exclusively. However, if Skan/Measure is selected, the meter uses Skan Only to find the acoustic signal and then tries to use the Skan/Measure technique for the actual measurement.

**Note:** *To change the Skan Only and Skan/Measure parameters, see the **Signal** submenu section on page 11 of this chapter.*

### Procedure Options

After completing the above step, the XGM868i returns to the Channel PROGRAM window. Do one of the following:

- To continue entering “quick startup” data, proceed to Step 3 in the following section.
- To continue regular programming, refer to Appendix A, *Menu Maps*, to navigate to the desired menu.
- To leave the *Keypad Program*, press [Escape] twice.

## 1.5 Entering System Data for the Channel

The Channelx-System submenu is used to enter system parameters for the channel. While following the programming instructions, refer to Figure 28 on page 69.

### 1.5.1 Accessing the Channelx-System Submenu

1. In the *Keypad Program*, scroll to PROG and press [Enter].
2. In the PROG menu, scroll to CH1 or CH2 and press [Enter].
3. In the Channel PROGRAM menu, scroll to SYSTM and press [Enter].
4. Use the arrow keys to enter the desired *Channel Label* (up to 5 characters) and press [Enter].
5. Use the arrow keys to enter the desired *Site/Channel Message* (up to 21 characters) and press [Enter].

### 1.5.2 Selecting Volumetric Units

1. Scroll to the desired *Volumetric Units* for the flow rate display and press [Enter]. Table 1 lists available units.
2. Scroll to the desired *Volumetric Time* units for the flow rate display and press [Enter].
3. Scroll to the desired number of *Vol. Decimal Digits* (digits to the right of the decimal point in the volumetric flow rate display) and press [Enter].

**Table 1: Available Volumetric/Totalizer Units**

English	Metric
ACF = Actual Cubic Feet	ACM = Actual Cubic Meters
KACF = Thousands of ACF	KACM = Thousands of ACM
MMACF = Millions of ACF	MMACM = Millions of ACM
SCF = Standard Cubic Feet	SCM = Standard Cubic Meters
KSCF = Thousands of SCF	KSCM = Thousands of SCM
MMSCF = Millions of SCF	MMSCM = Millions of SCM

### 1.5.3 Selecting Totalizer Units

1. Scroll to the desired *Totalizer Units* for a totalized flow rate display and press [Enter]. Table 1 lists available units.
2. Scroll to the desired number of *Tot Decimal Digits* (digits to the right of the decimal point in the totalized flow rate display) and press [Enter].
3. Do one of the following:
  - If MASS FLOW is ON, proceed to *Selecting the Mass Flow Units* on the following page.
  - If MASS FLOW is OFF, the meter returns to the Channel PROGRAM. Go to *Procedure Options* on the next page.

**Note:** To activate mass flow, refer to page 16.

## 1.5.4 Selecting Mass Flow Units

1. Scroll to the desired *Mass Flow* units for the flow rate display and press [Enter]. The available units for this prompt are determined by the selection made at System Units (see Table 2).

**Table 2: Available Mass Flow Units**

English	Metric
Pounds	Kilograms
Thousands of LB	Metric Tons (1,000 KG)
Millions of LB	
Tons (2,000 LB)	

2. Scroll to the desired *Mass Flow Time* units for the mass flow rate display and press [Enter].
3. Scroll to the desired number of *Mdot Decimal Digits* (digits to the right of the decimal point in the mass flow rate display) and press [Enter].
4. Scroll to the desired *Mass (Totalizer)* units for the totalized mass flow rate display and press [Enter]. The available units for this prompt are determined by the selection made at the *System Units* prompt.
5. Scroll to the desired number of *Mass Decimal Digits* (digits to the right of the decimal point in the totalized mass flow rate display) and press [Enter].

### Procedure Options

After completing the steps on the previous page, the XGM868i returns to the Channel PROGRAM window. Do one of the following:

- To continue entering “quick startup” data, continue to Step 1 in *Entering Transducer and Pipe Parameters* on the next page.
- To continue regular programming, refer to Appendix A, *Menu Maps*, to navigate to the desired menu.
- To leave the *Keypad Program*, press [Escape] twice.

## 1.6 Entering Transducer and Pipe Parameters

Enter the transducer and pipe parameters via the **PIPE** submenu. While following the programming instructions, refer to Figure 28 on page 69.

1. From the Channel PROGRAM menu, scroll to the PIPE option and press [Enter].
2. The first prompt asks for the *Transducer Number*.
  - For a standard transducer, use the arrow keys to enter the number engraved on the transducer head, and press [Enter].
  - If there is no number engraved on the transducer head, press the right arrow key to scroll to the *STD* option, and use the up and down arrow keys to change to *SPEC*. Then use the arrow keys to enter an assigned number (from 91 to 99), and press [Enter].

**IMPORTANT:** Special transducers have no engraved number on the head and are rarely used. Examine the transducer head carefully for a number.

- If you entered the number for a standard transducer, proceed to the *Pipe OD* prompt in step 5.
- If you entered the number for a special transducer, proceed to step 3 below.

### 1.6.1 Special Transducers

**Note:** For special transducers, Panametrics will supply a transducer data sheet with programming information.

3. Scroll to the transducer *Frequency* (supplied by the factory) and press [Enter].

**Note:** The frequency is required to transmit an excitation voltage at the transducer’s natural frequency.

4. Enter the special transducer  $T_w$  (time delay) value (supplied by the factory) and press [Enter].

$T_w$  is the time required for the transducer signal to travel through the transducer and its cable. This time delay must be subtracted from the transit times of the upstream and downstream transducers to ensure an accurate measurement.

## 1.6.2 Pipe Data

If either a standard or a special transducer is being used, the programming sequence should be rejoined at this point.

5. To select the appropriate *Pipe OD Unit* type from the list shown in Table 3, scroll to the right side of the screen, and use the up and down arrow keys to step through the list. Press [Enter]. Then use the arrow keys to enter the known pipe outside diameter or circumference on the left side and press [Enter].

Obtain the required information by measuring either the pipe outside diameter (OD) or circumference at the transducer installation site. The data may also be obtained from standard pipe size tables found in *Sound Speeds and Pipe Size Data* (914-004).

**Table 3: Available Pipe Size Units**

English	Metric
inches	mm = millimeters
feet	m = meters
in/PI = pipe circumference in inches	mm/PI = pipe circumference in millimeters
ft/PI = pipe circumference in feet	m/PI = pipe circumference in meters

6. Use the arrow keys to enter the known *Pipe Wall Thickness* (in inches or mm) and press [Enter]. If the pipe wall thickness is not available, look up the value in a table of standard pipe size data which can be found in the *Sound Speeds and Pipe Size Data* manual (914-004)

**IMPORTANT:** Because the units cannot be independently chosen for this parameter, the value must be entered in the same units used for the pipe OD/Circumference.

### 1.6.2.1 Path and Axial Lengths

7. To enter the *Path Length*:
  - a. Use the [▷] arrow key to highlight the path length unit type at the right of the screen. Then use the [△] and [▽] arrow keys to scroll to the desired unit type.
  - b. Use the [◀] arrow key to return to the numeric entry on the left, and enter the path length of the ultrasonic signal. Press [Enter].

### 1.6.2.1 Path and Axial Lengths (cont.)

**Note:** If a spoolpiece was ordered with the meter, the transducer signal path length (**P**) and the transducer signal axial length (**L**) are engraved on the flowcell and/or are included in the documentation supplied with the meter. For on-site transducer installations, refer to Appendix C, Measuring P and L Dimensions, in the Startup Guide.

8. In the same manner, enter the appropriate *Axial Length L* unit type and axial length of the ultrasonic signal, and press [Enter].
9. Scroll to the desired *Fluid Type* and press [Enter]. Then do one of the following:
  - If **OTHER** was selected – proceed to Step 10.
  - If **AIR** was selected – proceed to Step 11.
10. Use the arrow keys to enter the *Fluid Soundspeed* (in feet per second) in the gas to be measured and press [Enter].
11. Scroll to the appropriate choice to indicate whether you want *Reynolds Correction*, and press [Enter].
  - If *Off* is selected, go to Step 12.
  - If *On* is selected, the program asks for the *Kinematic Viscosity*. Use the arrow keys to enter the desired value, and press [Enter].
12. Use the arrow keys to enter a value for the flow *Calibration Factor* and press [Enter]. The default value is 1.00, but values between 0.50 and 2.0 may be entered.

#### Procedure Options

After entering the **Calibration Factor**, the XGM868i returns to the **Channel PROGRAM**. Do one of the following:

- To continue entering “quick startup” data, press [**Escape**] once and proceed to Step 1 in Entering Global System Data on page 18.
- To continue regular programming, refer to Appendix A, *Menu Maps*, to navigate to the desired menu.
- To leave the *Keypad Program*, press the [**Escape**] key twice.



## 1.7 Entering Zero Cutoff and Setting Up Inputs

Enter the zero cutoff value and set up the temperature and pressure inputs via the **I/O** submenu. While programming these parameters, refer to Figure 28 on page 69.

**IMPORTANT:** If an option card in **Slot 1** fails to appear in this menu, it may be turned **Off**. See the **Global-I/O-Options** section on page 22 for setup instructions.

### 1.7.1 Zero Cutoff Value

Near a zero flow rate, the Model XGM868i's readings may fluctuate due to small offsets caused by thermal drift or similar factors. To force a zero display reading when there is minimal flow, enter a *zero cutoff value* as described below.

1. In the *Keypad Program*, scroll to **PROG** and press [Enter].
2. In the **PROG** menu, scroll to **CH1** or **CH2** and press [Enter].
3. In the **Channel PROGRAM** menu, scroll to **I/O** and press [Enter].
4. Enter a value from 0 to 1 ft/sec (0 to 0.30 m/sec) for the *Zero Cutoff* and press [Enter]. The recommended setting is 0.0200 ft/sec (0.0009 m/sec).

### 1.7.2 Temperature Input

The XGM868i can use either a fixed temperature value or a live temperature input to calculate the density for the mass flow rate display.

1. Scroll to a *Fixed* temperature value or to set up the option card in *Slot 1* that will supply the live temperature input and press [Enter].

**Note:** *If Slot 1 contains an activated option card with an analog input assigned to **Temperature** or an **RTD** input, Slot 1 appears as an option at the above prompt. If the process temperature is stable, a fixed value may be used, but most applications require a live temperature input. If there is no active option card for temperature, the meter assumes you are using a fixed temperature.*

2. Proceed to one of the following sections:
  - If you selected *Fixed* – proceed to Step 3.
  - If you selected *Slot 1* – proceed to Step 4.
3. Enter the known *Fixed Temp.* (process temperature) and press [Enter]. The meter will accept values from  $-328^{\circ}$  to  $1,832^{\circ}\text{F}$  ( $-200^{\circ}$  to  $1,000^{\circ}\text{C}$ ). Proceed to *Base Temperature* on the next page.
4. Scroll to *Input A* or *Input B* and press [Enter]. The inputs were labeled during setup.

**Note:** *The set up of Input A is used as an example. Identical procedures would be used to set up Input B.*

### 1.7.3 Base Temperature

1. Use the arrow keys to enter the *Base Temperature* and press [Enter]. The ratio of this value to the actual temperature is used to calculate the standard mass flow rate.
2. Do one of the following:
  - If you selected *Pressure* as the Input Type, proceed to *Pressure Input* below.
  - If you selected *Temperature* as the Input Type, proceed to *Base Pressure* below.

### 1.7.4 Pressure Input

1. Scroll to a *Fixed* pressure value or to set up the option card in *Slot 1* that will supply the live pressure input and press [Enter].

**Note:** *If Slot 1 contains an activated option card with an input assigned to **Pressure, Slot 1** appears as an option at the above prompt. If the process pressure is stable, a fixed value may be used, but most applications require a live pressure input. If there is no active option card for pressure, the meter assumes you are using a fixed pressure.*

2. Proceed to one of the following steps:
  - If you selected *Fixed* - proceed to Step 3.
  - If you selected *Slot 1* - proceed to Step 4.
3. Enter the known *Fixed* process *Pressure* and press [Enter]. The meter will only accept values from 0 to 5,000 psia. Proceed to *Base Pressure* below.
4. Scroll to *Input A* or *Input B* and press [Enter]. The inputs were labeled during setup.

**Note:** *The set up of Input A is used as an example. Identical procedures would be used to set up Input B.*

### 1.7.5 Base Pressure

1. Enter the *Base Pressure* and press [Enter]. The ratio of this value to the actual pressure is used to calculate the standard mass flow rate.

### 1.7.6 Low Pressure Switch

1. Scroll to *Yes* or *No* to activate or deactivate the *Low Pressure Switch* software function and press [Enter].
2. Proceed to one of the following steps:
  - If you selected *Yes* – proceed to Step 3.
  - If you selected *No* – go to *Procedure Options* below.
3. Enter the *Pressure Limit*, the low pressure switch set point, and press [Enter]. The acceptable range is 0 to 5,000 psia. The meter will stop taking readings if the pressure drops below this value.

#### Procedure Options

After completing the above steps, the XGM868i returns to the Channel PROGRAM window. Do one of the following:

- To continue programming, refer to Appendix A, *Menu Maps*, to navigate to the desired menu.
- To leave the *Keypad Program*, press [Escape] three times.

## 1.8 Entering Setup Data

The signal limits, response times, mass flow and multiple K factors for the Model XGM868i are specified via the **Setup** submenu. The following four submenus are included in this section:

- **Signal** – set the parameters related to the transducer signal (see below).
- **Default Setup** – reset all parameters to default values (page 14).
- **V averaging** – specify the response of the meter to step changes (page 14).
- **Advanced Features** – enable mass flow and enter K factors (page 15).

While following the programming instructions, refer to Figure 29 on page 70. Record all programmed data in Appendix B, *Data Records*.

### 1.8.1 Setting Transducer Signal Parameters

Use this option to set the limits for the incoming signal and other parameters affecting the transducer signal. For example, the programmed signal strength low limit may be used to determine the trigger point for an alarm.

**CAUTION!** The Signal default settings are suitable for most applications. Consult the factory before changing any of these parameters.

Only after consulting the factory, complete the following steps to program the signal parameters:

1. In the *Keypad Program*, scroll to PROG and press [Enter].
2. In the PROG menu, scroll to CH1 or CH2 and press [Enter].
3. In the Channel PROGRAM menu, scroll to Setup and press [Enter].
4. Scroll to SIGNL and press [Enter].
5. Use Table 4 on the next page to choose the desired values. Use the arrow keys to enter a value (or scroll to a value for a parameter with menu options) and press [Enter].

#### Procedure Options

After completing the above steps, the XGM868i returns to the Channel SET UP window. Do one of the following:

- To continue programming, refer to Appendix A, *Menu Maps*, to navigate to the desired menu.
- To leave the *Keypad Program*, press [Escape] three times.

## 1.8.1 Setting Transducer Signal Parameters (cont.)

**Table 4: Transducer Signal Settings**

Transducer Signal Parameters	Range	Default Value	Description
Signal Low Limit	-20 to 100	20	The E1:LOW SIGNAL error message appears when the signal strength falls below the programmed SIGNAL LOW LIMIT value. See Chapter 2 in the Service Manual for a discussion of error codes.
Correlation Peak Limit	0 to 500	100	The <b>E4: SIGNAL QUALITY</b> error message appears when the signal quality falls below the programmed <b>COR. PEAK LIMIT</b> value. See Chapter 2 in the Service Manual for a discussion of error codes
Soundspeed+ - Limit	1 to 50%	20%	The E2:SOUNDSPEED error message appears when the calculated fluid sound speed differs from the fluid sound speed entered in the Channelx-System menu by more than the programmed SOUNDSPEED +- LIMIT value. See Chapter 2 in the Service Manual for a discussion of error codes.
Velocity Low Limit	-500 to 500 ft/sec (-150 to 150 m/sec)	-150 ft/sec (-46 m/sec)	The E3: VELOCITY RANGE error messages appears when the calculated fluid velocity is less than the programmed VELOCITY LOW LIMIT value. See Chapter 2 in the Service Manual for a discussion of error codes.
Velocity High Limit	-500 to 500 ft/sec (-150 to 150 m/sec)	150 ft/sec (46 m/sec)	The E3: VELOCITY RANGE error messages appears when the calculated fluid velocity exceeds the programmed VELOCITY HIGH LIMIT value. See Chapter 2 in the Service Manual for a discussion of error codes.
Acceleration Limit	0 to 250 ft/s (0 to 76 m/s)	15 ft/s (5 m/s)	The <b>E6: CYCLE SKIP</b> error message appears when the calculated fluid velocity changes by more than the programmed <b>ACCELERATION LIMIT</b> value from one reading to the next. See Chapter 2 in the Service Manual for a discussion of error codes.
Amplitude Discriminator Low	0 to 100	14	The amplitude discriminator measures the transducer signal received by the Model XGM868i. The default value for the above parameter is 14, and values from 0 to 100 are acceptable. The <b>E5: AMPLITUDE</b> error message appears when the amplitude discriminator falls below the programmed <b>AMP. DISCRIM LOW</b> value. See Chapter 2 in the Service Manual for a discussion of error codes.
Amplitude Discriminator High	0 to 100	34	The amplitude discriminator measures the transducer signal received by the Model XGM868i. The default value for the above parameter is 34, and values from 0 to 100 are acceptable. The <b>E5: AMPLITUDE</b> error message appears when the amplitude discriminator exceeds the programmed <b>AMP. DISCRIM HIGH</b> value. See Chapter 2 in the Service Manual for a discussion of error codes.
Delta T Offset	-1000 to 1000 $\mu$ sec	0 $\mu$ sec	An offset between the upstream and downstream transit times is specified at this prompt.
Skat T Offset	-500 to 500 $\mu$ sec	58 $\mu$ sec	At this prompt, specify a time measurement offset that compensates for any shift resulting from cross-correlation. Set to 0 for active Skat T Offset.
% of Peak	1 to 100%	50%	The percentage of peak used to calculate the transit times and Delta T is specified at this prompt.

Table 4: Transducer Signal Settings (cont.)

Transducer Signal Parameters	Range	Default Value	Description
M>S Switch	0 to 250 $\mu$ sec	50 $\mu$ sec	If the burst mode is set to Skan/Measure (S/M), the meter switches from Skan to Measure Mode when Delta T is less than the <b>M&gt;S_Switch</b> value. <b>DO NOT</b> change this value unless advised to do so by the factory.
# Shifts	0 to 10	3	The number of shifts corresponds to the actual number of transmits per cycle (number of signals added together in one direction to produce an averaged signal for one interrogation of the fluid) and need only be changed if the environment is very noisy or the acoustic signal is weak.
A Divisor	0.1 to 10	2.5	<b>A Divisor</b> is used to calculate the Measure Mode integrated threshold level and is not normally changed.
# Transmit Pulses	1 to 16	4	<b># Transmit Pulses</b> specifies the number of pulses in a burst. For difficult conditions (i.e. long paths, high velocity or high temperature), settings as high as 16 may be necessary.
T Window (cycles)	0 to 1000	0	The XGM868i calculates the size of the transmit window based on pipe size and fluid sound speed. However, for diagnostic purposes, the window size may be reset.
R Window (cycles)	10 to 128	10	The XGM868i calculates the size of the receive window based on pipe size and fluid soundspeed. However, for diagnostic purposes, the window size may be reset.

## 1.8.2 Initializing Setup Parameters – Default Setup

Use this option to initialize (reset) all of the parameters within the **Setup** menu to their default values. Complete the following steps to reset all of the parameters:

1. In the *Keypad Program*, scroll to PROG and press [Enter].
2. In the PROG menu, scroll to CH1 or CH2 and press [Enter].
3. In the Channel PROGRAM menu, scroll to Setup and press [Enter].
4. Scroll to INIT. Press [Enter].
5. Scroll to Yes to initialize default parameters or No to abort this command. Press [Enter].

### Procedure Options

After completing the above steps, the XGM868i returns to the Channel Set up window. Do one of the following:

- To continue programming, refer to Appendix A, *Menu Maps*, to navigate to the desired menu.
- To leave the *Keypad Program*, press [Escape] four times.

## 1.8.3 Setting Response Time – V Averaging

Use this option to specify the number of readings that occur before the meter will respond to a step change in flow rate. In general, the smaller the number of readings, the less steady the display will appear. Complete the following steps to set the response time:

**IMPORTANT:** Do not change this number unless instructed to do so by Panametrics personnel.

1. In the *Keypad Program*, scroll to PROG and press [Enter].
2. In the PROG menu, scroll to CH1 or CH2 and press [Enter].
3. In the Channel PROGRAM menu, scroll to Setup and press [Enter].
4. Scroll to AVRГ and press [Enter].
5. Scroll to the *Response Time* (in number of readings) from the pull-down menu and press [Enter]. For best results, select a value of 30 to ensure the most stable signal.

### Procedure Options

After completing the above steps, the XGM868i returns to the Channel SET UP window. Do one of the following:

- To continue programming, refer to Appendix A, *Menu Maps*, to navigate to the desired menu.
- To leave the *Keypad Program*, press [Escape] four times.

## 1.8.4 Using Advanced Features

This option enables you to access the more advanced features of the meter. In this option you can do the following:

- *enter a table of K factors* – to compensate for non-linear flow rates (see below).
- *enable mass flow* – calculated for static fluid density (see the next page).

### 1.8.4.1 Entering K Factors

Use this option to enter a table of K factors. K factors are used to create a curve for the flow range (based on velocity) that compensates for non-linear flow rates. The meter accepts from 2 to 20 data pairs. Complete the following steps to enter multiple K factors for velocity values:

**Note:** *The K factors are supplied by the factory; without them the K factor table cannot be edited.*

1. In the *Keypad Program*, scroll to PROG and press [Enter].
2. In the PROG menu, scroll to CH1 or CH2 and press [Enter].
3. In the Channel PROGRAM menu, scroll to Setup and press [Enter].
4. Scroll to ADVAN. Press [Enter].
5. Scroll to MULTK, and press [Enter].
6. Scroll to Yes to activate, or to No to deactivate multiple K factors, and press [Enter].

**Note:** *If you selected No, go to Procedure Options below.*

7. Scroll to the *Custom Type* of K factor desired: CstV (velocity) or CstR (Reynolds). Press [Enter].
8. Scroll to Yes to *Edit Table*, or to No to retain the current values, and press [Enter].

**Note:** *If you scroll to No, go to Procedure Options on the next page.*

### 1.8.4.2 Editing K Factors

1. Use the arrow keys to enter the number of K factors (2 to 20) in the table and press [Enter].
2. Enter the velocity (or Reynolds) value for K factor number “X” and press [Enter].

**Note:** *When editing the K factor table, the velocities must be entered in increasing order.*

3. Enter the K factor corresponding to velocity number “X” (0.333 to 3.0) and press [Enter].
4. Repeat Steps 2 and 3 for each pair of values.

### Procedure Options

After completing the previous steps, the XGM868i returns to the Advanced Features window. Do one of the following:

- To continue programming, refer to Appendix A, *Menu Maps*, to navigate to the desired menu.
- To leave the *Keypad Program*, press [Escape] five times.

### 1.8.4.3 Activating Mass Flow

Use this option to calculate mass flow from a static fluid density. Complete the following steps to enter the static density of the fluid:

**IMPORTANT:** The Model XGM868i can use a static density from either a single value of density (Rho), or from the live or fixed temperature and pressure inputs, as programmed in the I/O menu, along with a single entered value of Molecular Weight (MW). This is done by setting the Mass flow calculation prompt to Yes **and following the prompts below to calculate mass flow.**

1. In the *Keypad Program*, scroll to PROG and press [Enter].
2. In the PROG menu, scroll to CH1 or CH2 and press [Enter].
3. In the Channel PROGRAM menu, scroll to Setup and press [Enter].
4. Scroll to ADVAN. Press [Enter].
5. Scroll to MASS, and press [Enter].
6. Scroll to Yes to activate, or to No to deactivate *Static Density*, and press [Enter].  
**Note:** If you scroll to No, go to Procedure Options below.
7. Scroll to the *Density Type* (fluid density (Rho) or molecular weight (Mw)) and press [Enter].
8. Do one of the following:
  - If you selected Rho - proceed to Step 9.
  - If you selected Mw - proceed to Step 11.
9. Scroll to the type of volumetric units (standard - StVOL or actual-AcVOL) for the measurement data display and press [Enter].
10. Enter the *Fluid Density* (0.00001 to 0.100 lb/ft<sup>3</sup> or 0.00001 to 123.18 kg/m<sup>3</sup>) and press [Enter]. Go to *Procedure Options* below.
11. Enter the *Molecular Weight* and press [Enter].

#### Procedure Options

After completing the steps on the previous page, the XGM868i returns to the Advanced Features window. Do one of the following:

- To continue programming, refer to Appendix A, *Menu Maps*, to navigate to the desired menu.
- To leave the *Keypad Program*, press [Escape] five times.



## 1.9 Entering Global Data

The **Global** menu is used to enter information that is not specific to either of the individual channels. Information programmed via this menu is used to compute parameters such as the sum, difference or average of the channel 1 and channel 2 signals (for a 2-Channel meter). In addition, several general system parameters may be entered in the **Global** menu.

**IMPORTANT:** When calculating the **sum**, **difference** or **average** readouts, data from the **Global-System** submenu is used. Any conflicting data entered in the **Channelx-System** submenu is overridden.

The following submenus are included in the **Global** menu:

- **SYSTEM** - use to specify the units of measure used in calculations (see the next page).
- **I/O** - used to set up error handling and to configure analog inputs and outputs (see page 20).
- **COMM** - used to set up the serial communications port (see page 31).

Based on the selection made above, proceed to the appropriate section of this chapter for instructions. While following the programming instructions, refer to Figure 30 on page 71. Remember to record all programmed data in Appendix B, *Data Records*.

## 1.9.1 Entering Global System Data

This menu enables you to select the system units that the XGM868i will use when channel data is added, subtracted or averaged together.

1. In the *Keypad Program*, scroll to PROG and press [Enter].
2. In the PROG menu, scroll to GLOBL and press [Enter].
3. In the Global PROGRAM menu, scroll to SYSTM and press [Enter].
4. At the *System Units* prompt, scroll to *Eng* to display measurements in English units or to *Metrc* for metric units and press [Enter].
5. Scroll to the desired *Pressure Units* (absolute or gauge) and press [Enter].
6. Do one of the following:
  - If absolute was selected, proceed immediately to Step 7.
  - If gauge was selected, enter the desired *Atmospheric Pressure*, press [Enter] and proceed to the next step.
7. Do one of the following:
  - 1-Channel meter, go to *Procedure Options* on page 19.
  - 2-Channel meter, proceed to *Selecting Volumetric Units* below.

### 1.9.1.1 Selecting Volumetric Units

1. Scroll to the desired *Volumetric Units* for the flow rate display and press [Enter]. Available units are listed in Table 5.

**Table 5: Available Volumetric/Totalizer Units**

English	Metric
ACF = Actual Cubic Feet	ACM = Actual Cubic Meters
KACF = Thousands of ACF	KACM = Thousands of ACM
MMACF = Millions of ACF	MMACM = Millions of ACM
SCF = Standard Cubic Feet	SCM = Standard Cubic Meters
KSCF = Thousands of SCF	KSCM = Thousands of SCM
MMSCF = Millions of SCF	MMSCM = Millions of SCM

2. Scroll to the desired *Time* units for the flow rate display and press [Enter].
3. Scroll to the desired number of *Vol Decimal Digits* (digits to the right of the decimal point in the volumetric flow rate display) and press [Enter].

### 1.9.1.2 Selecting Totalizer Units

1. Scroll to the desired *Totalizer Units* for the totalized flow rate display and press [Enter]. Available units are listed in Table 5 on the previous page.
2. Scroll to the desired number of *Tot Decimal Digits* (digits to the right of the decimal point in the totalized flow rate display) and press [Enter].
3. Do one of the following:
  - If MASS FLOW is ON, proceed to *Selecting the Mass Flow Units* below.
  - If MASS FLOW is OFF, the meter returns to the Channel PROGRAM window. Go to *Procedure Options* on the following page.

**Note:** To activate mass flow, refer to page 16. The following prompts will only appear if mass flow is activated for both channels.

### 1.9.1.3 Selecting Mass Flow Units

1. Scroll to the desired *Mass Flow* units for the flow rate display and press [Enter]. The available units for this prompt are determined by the selection made at System Units (see Table 6).

**Table 6: Available Mass Flow Units**

English	Metric
LB = Pounds	KG = Kilograms
KLB = Thousands of LB	Tonne = Metric Tons (1,000 KG)
MMLB = Millions of LB	
Tons (2,000 LB)	

2. Scroll to the desired *Mass Flow Time* units for the mass flow rate display and press [Enter].
3. Scroll to the desired number of *Mdot Decimal Digits* (digits to the right of the decimal point in the mass flow rate display) and press [Enter].
4. Scroll to the desired *Mass (Totalizer)* units for the totalized mass flow rate display and press [Enter]. The available units for this prompt are determined by the selection made at the *System Units* prompt.
5. Scroll to the desired number of *Mass Decimal Digits* (digits to the right of the decimal point in the totalized mass flow rate display) and press [Enter].

### Procedure Options

After completing the previous steps, the XGM868i returns to the Global PROGRAM window. Do one of the following:

- To continue programming, refer to Appendix A, *Menu Maps*, to navigate to the desired menu.
- To leave the *Keypad Program*, press [Escape] twice.

## 1.9.2 Setting Up Inputs and Outputs

Set up the XGM868i's inputs and outputs via the **I/O** submenu. While following the programming instructions, refer to Figure 30 on page 71 and Figure 31 on page 72. The following three submenus are included in this section:

- **ERROR** - program the meter's response during an error condition (see below)
- **OPTN** - set up any option cards and the **Slot 0** analog outputs (page 22)
- **LCD** - set up the LCD display. Refer to Chapter 2, *Displaying Data*.

**Note:** *In this section, **Slot 1** appears as an option only if a suitable option card is installed in Slot 1.*

Proceed to the appropriate section to program the option selection made at the above prompt. Remember to record all programmed data in Appendix B, *Data Records*.

### 1.9.2.1 Selecting Error Handling

This menu option permits programming of the manner in which the Model XGM868i's outputs respond during an error condition. See Chapter 2, *Error Codes*, in the *Service Manual* for a discussion of the built-in error codes. To access this submenu:

**Note:** *The 2-Channel meters have an additional option for error handling.*

1. In the *Keypad Program*, scroll to PROG and press [Enter].
2. In the PROG menu, scroll to GLOBL and press [Enter].
3. In the Global PROGRAM menu, scroll to I/O and press [Enter].
4. Scroll to ERROR and press [Enter].
5. Scroll to the desired option for error handling and press [Enter]. If you select Error Level in mA, proceed to Step 6 on the next page. (See Table 7 on page 21 for a description of error handling options available and how the totalizers and analog outputs respond to them.)

**Note:** *The error responses listed in Table 7 on page 21 apply only to the **Channelx** measurement mode and to the **Sum/Difference** measurement modes, if either or both channels are in error. Error handling in the **Average** measurement mode is set in Step 7 on page 21.*

### 1.9.2.1 Selecting Error Handling (cont.)

**Table 7: Error Response Options**

Option	Output Response	Totalizer Response
HOLD	Holds the last “good” reading.	Continues to totalize, based on last “good” flow reading.
LOW	Forces outputs to the low set point.	Stops totalizing.
HIGH	Forces outputs to the high set point.	Stops totalizing.
HHIGH	Forces outputs ≈10% above the high set point.	Stops totalizing.
OTHER	Forces outputs to the entered mA level.	Stops totalizing during critical errors.

6. Use the arrow keys to enter a specific current that will signify meter errors and press [Enter]. Then, do one of the following:
  - For a 1-Channel meter, go to *Procedure Options* on the next page.
  - For a 2-Channel meter – proceed to Step 7 below.
7. Scroll to *Yes* or *No* to enable or disable 2-path error handling. Specific responses of the display and the totalizer are listed in Table 8. The **2-path error handling** option is intended for applications where two sets of transducers are installed in the same location in the same pipe to improve accuracy and the meter is operated in **AVE** mode. With this function enabled, the Model XGM868i performs error handling only if both channels are in error. If this function is disabled, error handling occurs when either channel goes into error.

**Table 8: 2-Path Error Response Options**

Option	Display Response	Totalizer Response
No	Displays the average of <b>Channel 1</b> and <b>Channel 2</b> , regardless of the error state of either channel.	Outputs the average of Channel 1 and Channel 2 totals, regardless of the error state of either channel.
Yes	<ol style="list-style-type: none"> <li>1. If one channel is in error, the other channel’s value is displayed as the average.</li> <li>2. If both channels are in error, the last average reading is held.</li> </ol>	<ol style="list-style-type: none"> <li>1. If one channel is in error, totalizing continues.</li> <li>2. If both channels are in error, totalizing stops.</li> </ol>

#### Procedure Options

After completing the above steps, the XGM868i returns to the **Global I/O** window. Do one of the following:

- To continue programming, refer to Appendix A, *Menu Maps*, to navigate to the desired menu.
- To leave the *Keypad Program*, press [Escape] four times.

### 1.9.2.2 Setting Up Slot 0 and Slot 1 Input/Outputs

The Model XGM868i has two built-in analog outputs, which are assigned to **Slot 0**. Also, a variety of input/output option cards may be installed in **Slot 1**. See Chapter 1, *Installation*, of the *Startup Guide* for a complete description of the available option cards.

To set up option cards, refer to one of the following sections:

- Analog Outputs - refer to section below.
- Analog Inputs - see page 25
- RTD Inputs - see page 26
- Alarm Relays - see page 27
- Totalizer Outputs - see page 28
- Frequency Outputs - see page 30

### 1.9.2.3 Analog Outputs

While following the programming instructions, refer to Figure 31 on page 72.

#### Accessing the Output

1. In the *Keypad Program*, scroll to PROG and press [Enter].
2. In the PROG menu, scroll to GLOBL and press [Enter].
3. In the Global PROGRAM menu, scroll to I/O and press [Enter].
4. Scroll to OPTN and press [Enter].
5. Scroll to Slot 0 or Slot 1, depending on which output you want to set up.
6. Scroll to the desired *Output* and press [Enter].

**Note:** *Output letters (A, B, etc.) correspond to the output wiring terminal numbers from top to bottom. For example, Output A corresponds to pins 1,2 and 3; Output B corresponds to pins 4, 5 and 6; etc.*

## Setting Up the Output Scale

1. Scroll to the desired output scale and press [Enter].
2. Do one of the following:
  - If you selected *Off*, the XGM868i returns to the I/O window. Go to *Procedure Options* on page 24.
  - If you selected *0-20 mA* or *4-20 mA*, and are using a
    - 1-Channel meter, proceed to Step 4 below.
    - 2-Channel meter, proceed to the next step.
3. Scroll to the desired *Channel* option (CH1, CH2, SUM, DIF or AVE) and press [Enter].
4. Scroll to the desired *Measurement Parameter* and press [Enter]. See Table 9 for a description of the available options.
5. At Zero, enter a value for the low end of the analog output range and press [Enter].
6. At Full, enter a value for the high end of the analog output range and press [Enter].

**Table 9: Available Measurement Parameters**

Option Bar	Description	Good	Bad
<b>VEL</b>	Displays the flow velocity.	N.A.	N.A.
<b>VOLUM</b>	Displays the volumetric flow.	N.A.	N.A.
<b>+TOTL</b>	Displays the forward totalized volume flow.	N.A.	N.A.
-TOTL	Displays the reverse totalized volume flow.	N.A.	N.A.
TIMER	Displays the total flow measurement time.	N.A.	N.A.
MDOT	Displays the mass flow.	N.A.	N.A.
+MASS	Displays the forward totalized mass flow.	N.A.	N.A.
-MASS	Displays the reverse totalized mass flow.	N.A.	N.A.
SS up	Displays the signal strength for the upstream transducer.	50-75	<50 or >75
SS do	Displays the signal strength for the downstream transducer.	50-75	<50 or >75
SNDSP	Displays the measured speed of sound in the gas.	N.A.	N.A.
Tup	Displays the upstream ultrasonic signal transit time.	N.A.	N.A.
Tdown	Displays the downstream ultrasonic signal transit time.	N.A.	N.A.
DELTA	Displays the transit time difference between the upstream and downstream signals.	N.A.	N.A.
Tot K	K factor, based on the Reynolds number.	N.A.	N.A.
PEAK%	Displays the percentage of peak (set to +50 by default).	N.A.	N.A.
Qup	Displays the signal quality for the upstream transducer.	Š 1200	-400 to +400
Qdown	Displays the signal quality for the downstream transducer.	Š 1200	-400 to +400
AMPup	Displays the value for the signal amplitude of the upstream transducer.	24 ± 5	<19 or >29
AMPdn	Displays the value for the signal amplitude of the downstream transducer.	24 ± 5	<19 or >29
CNTup	Displays the AGC DAC count for the upstream gain setting.	N.A.	N.A.
CNTdn	Displays the AGC DAC count for the downstream gain setting.	N.A.	N.A.
P#up	Displays signal peaks for the upstream transducer.	100-2300	<100 or >2300
P#dn	Displays signal peaks for the downstream transducer.	100-2300	<100 or >2300
TEMP	Displays the gas temperature (from 0/4-20 mA input).	N.A.	N.A.
PRESR	Displays the gas pressure (from 0/4-20 mA input).	N.A.	N.A.

**Table 9: Available Measurement Parameters**

Option Bar	Description	Good	Bad
AcVOL	Displays actual volumetric flow.	N.A.	N.A.
StVOL	Displays standard volumetric flow.	N.A.	N.A.
Tu S <sup>1</sup>	Displays Skan transit time upstream.	N.A.	N.A.
Td S <sup>1</sup>	Displays Skan transit time downstream.	N.A.	N.A.
DT S <sup>1</sup>	Displays Skan Delta T.	N.A.	N.A.
Tu M <sup>1</sup>	Displays Measure transit time upstream.	N.A.	N.A.
Td M <sup>1</sup>	Displays Measure transit time downstream.	N.A.	N.A.
DT M <sup>1</sup>	Displays Measure Delta T.	N.A.	N.A.
Vinst	Displays the instantaneous velocity.	N.A.	N.A.

<sup>1</sup>available only if Burst Mode = S/M

**Note:** The measurement units that appear in these prompts are those selected in the **Global-System** window earlier in this section.

### Procedure Options

After completing the above steps, the XGM868i returns to the I/O window. Do one of the following:

- To continue programming, refer to Appendix A, *Menu Maps*, to navigate to the desired menu.
- To leave the *Keypad Program*, press [Escape] three times.



### 1.9.2.4 Analog Inputs

Refer to Figure 31 on page 72, and complete the following steps to set up the analog inputs of an option card installed in **Slot 1**:

#### Accessing the Input

1. In the *Keypad Program*, scroll to PROG and press [Enter].
2. In the PROG menu, scroll to GLOBL and press [Enter].
3. In the Global PROGRAM menu, scroll to I/O and press [Enter].
4. Scroll to OPTN and press [Enter].
5. Scroll to Slot 1 and press [Enter].
6. Scroll to the desired *Input* and press [Enter].

**Note:** *Input letters (A, B, etc.) correspond to input wiring terminal numbers from top to bottom (e.g. Input A corresponds to pins 1,2 and 3; Input B corresponds to pins 4, 5 and 6; etc.).*

#### Setting Up the Input

1. Enter a *Label* of up to eight characters for input and press [Enter].
2. Scroll to the desired input *Measurement* and press [Enter]. Do one of the following:
  - If **Off** was selected, go to *Procedure Options* below.
  - If **Pressure** or **Temperature** was selected, proceed to Step 5.
  - If **Special** was selected to set up the input as a live special input, proceed to the next step.
3. Use the arrow keys to enter a *Name* for the input and press [Enter].
4. Use the arrow keys to enter a *Unit* of measurement for the input and press [Enter].
5. Use the arrow keys to enter a value (a temperature value for special inputs) for the low end of the analog input range and press [Enter].
6. Use the arrow keys to enter a value (a temperature value for special inputs) for the high end of the analog input range and press [Enter].

#### Procedure Options

After completing the above steps, the XGM868i returns to the I/O window. Do one of the following:

- To continue programming, refer to Appendix A, *Menu Maps*, to navigate to the desired menu.
- To leave the *Keypad Program*, press [Escape] three times.

### 1.9.2.5 RTD Inputs

Option cards with RTD inputs have a temperature range of  $-148$  to  $662^{\circ}\text{F}$  ( $-100$  to  $350^{\circ}\text{C}$ ). While following the programming instructions, refer to Figure 31 on page 72, and complete the following steps to set up the RTD inputs of an option card installed in Slot 1.

#### Accessing the Input

1. In the *Keypad Program*, scroll to PROG and press [Enter].
2. In the PROG menu, scroll to GLOBL and press [Enter].
3. In the Global PROGRAM menu, scroll to I/O and press [Enter].
4. Scroll to OPTN and press [Enter].
5. Scroll to Slot 1 and press [Enter].
6. Scroll to the desired *Input* and press [Enter].

**Note:** *Input letters (A, B, etc.) correspond to input wiring terminal numbers from top to bottom (e.g. Input A corresponds to pins 1,2 and 3; Input B corresponds to pins 4, 5 and 6; etc.).*

#### Setting Up the RTD Input

1. Enter a *Label* for the RTD input and press [Enter].
2. Scroll to the desired input type and press [Enter]. Do one of the following:
  - If **Off** was selected, go to *Procedure Options* below.
  - If **Temperature** was selected, proceed to the next step.
3. Enter a temperature value for the *Low* end of the analog input range and press [Enter].
4. Enter a temperature value for the *High* end of the analog input range and press [Enter].

#### Procedure Options

After completing the above steps, the XGM868i returns to the I/O window. Do one of the following:

- To continue programming, refer to Appendix A, *Menu Maps*, to navigate to the desired menu.
- To leave the *Keypad Program*, press [Escape] four times.

### 1.9.2.6 Alarm Relays

Refer to Figure 31 on page 72, and complete the following steps to set up the alarm relays of an option card installed in **Slot 1**:

#### Accessing the Alarm Relay

1. In the *Keypad Program*, scroll to PROG and press [Enter].
2. In the PROG menu, scroll to GLOBL and press [Enter].
3. In the Global PROGRAM menu, scroll to I/O and press [Enter].
4. Scroll to OPTN and press [Enter].
5. Scroll to Slot 1 and press [Enter].
6. Scroll to the desired *Output* and press [Enter].

**Note:** *Output letters (A, B, etc.) correspond to the output wiring terminal numbers from top to bottom (e.g. Output A corresponds to pins 1,2 and 3; Output B corresponds to pins 4, 5 and 6; etc.).*

#### Selecting the Alarm Type

1. Scroll to the desired *Alarm* type and press [Enter].
2. Do one of the following:
  - If you selected *Off*, the XGM868i returns to the I/O window. Go to *Procedure Options* on the next page.
  - If you selected *High, Low* or *Fault*, proceed to the next step.
3. Scroll to the appropriate mode (*Standard* or *Failsafe*), and press [Enter]. (See Chapter 1, *Installation*, of the *Startup Guide* for wiring instructions.)
4. Do one of the following:
  - If you are using a 1-Channel meter and selected
    - high or low - proceed to Step 7 on the next page.
    - fault - proceed to Step 9 on the next page.
  - If you are using a 2-Channel meter, proceed to the next step.
5. Scroll to the desired *Channel* option and press [Enter].

## 1.9.2.6 Alarm Relays (cont.)

### Selecting the Alarm Type (cont.)

6. Do one of the following:
  - high or low - proceed to Step 7 below.
  - fault - proceed to Step 9 below.
7. Scroll to the desired measurement parameter and press [Enter]. (See Table 9 on page 26 for a description of the available options.)

**Note:** *The measurement units that appear in these prompts are those selected in the **Global-System** window earlier in this section.*

8. Enter a value for the *Trigger Point* of the alarm and press [Enter]. Go to *Procedure Options* below.
9. Scroll to the type of *Error* (flow, non-flow or both) that will trigger the fault alarm and press [Enter].

### Procedure Options

After completing the previous steps, the XGM868i returns to the I/O window. Do one of the following:

- To continue programming, refer to Appendix A, *Menu Maps*, to navigate to the desired menu.
- To leave the *Keypad Program*, press [Escape] three times.

## 1.9.2.7 Totalizer Outputs

The totalizer output issues one pulse per selected volume of flow. The meter produces a pulse each time the programmed amount of flow passes through the pipe. Refer to Figure 31 on page 72, and complete the following steps to set up the totalizer outputs of an option card installed in **Slot 1**:

### Accessing the Totalizer Output

1. In the *Keypad Program*, scroll to PROG and press [Enter].
2. In the PROG menu, scroll to GLOBL and press [Enter].
3. In the Global PROGRAM menu, scroll to I/O and press [Enter].
4. Scroll to OPTN and press [Enter].
5. Scroll to Slot 1 and press [Enter].
6. Scroll to the desired *Output* and press [Enter].
7. Do one of the following:
  - If you selected *Off*, the XGM868i returns to the I/O window. Go to *Procedure Options* on the following page.
  - If you selected *TTLZR*, and are using a
    - 1-Channel meter, proceed to Step 2 on the next page.
    - 2-Channel meter, proceed to Step 1 on the next page.

**Note:** *Output letters (A, B, etc.) correspond to the output wiring terminal numbers from top to bottom (e.g. Output A corresponds to pins 1,2 and 3; Output B corresponds to pins 4, 5 and 6; etc.).*

### 1.9.2.7 Totalizer Outputs (cont.)

#### Setting Up the Totalizer

1. Scroll to the desired *Channel* option and press [Enter].
2. Scroll to the desired *Measurement* parameter and press [Enter]. See Table 10 for a list of the available options.

**Table 10: Output Measurement Options**

Forward Totalized Volume Flow
Reverse Totalized Volume Flow
Forward Totalized Mass Flow
Reverse Totalized Mass Flow

**Note:** The measurement units that appear in these prompts are those selected in the **Global-System** window earlier in this section.

3. Use the arrow keys to enter a value for the minimum *Pulse On* time (between 1  $\mu$ sec and 10,000  $\mu$ sec) for the frequency of the totalizer pulses and press [Enter].

**Note:** A complete pulse consists of equal amounts of ON and OFF times. Choose a value that is compatible with the frequency counter to be used.

4. Use the arrow keys to enter a value for the number of measurement units represented by each pulse and press [Enter].

#### Procedure Options

After completing the above steps, the XGM868i returns to the I/O window. Do one of the following:

- To continue programming, refer to Appendix A, *Menu Maps*, to navigate to the desired menu.
- To leave the *Keypad Program*, press [Escape] three times.

### 1.9.2.8 Frequency Outputs

The frequency output issues a continuous signal with a frequency proportional to the selected measurement. Refer to Figure 31 on page 72, and complete the following steps to set up the totalizer outputs of an option card installed in **SLOT 1**:

#### Accessing the Frequency Output

1. In the *Keypad Program*, scroll to PROG and press [Enter].
2. In the PROG menu, scroll to GLOBL and press [Enter].
3. In the Global PROGRAM menu, scroll to I/O and press [Enter].
4. Scroll to OPTN and press [Enter].
5. Scroll to Slot 1 and press [Enter].
6. Scroll to the desired *Output* and press [Enter].
7. Do one of the following:
  - If you selected *Off*, the XGM868i returns to the Input/Output window. Go to *Procedure Options* on the following page.
  - If you selected *Frequency*, and are using a
    - 1-Channel meter, proceed to Step 2 on the next page.
    - 2-Channel meter, proceed to Step 1 on the next page.

**Note:** *Output letters (A, B, etc.) correspond to the output wiring terminal numbers from top to bottom (e.g. Output A corresponds to pins 1,2 and 3; Output B corresponds to pins 4, 5 and 6; etc.).*

#### Setting Up the Frequency

1. Scroll to the desired *Channel* option and press [Enter].
2. Scroll to the desired *Measurement* parameter and press [Enter]. See Table 9 on page 26 for a description of the available options. Refer to page 3-2 in the *Service Manual* for a description of diagnostic parameters.

**Note:** *The measurement units that appear in these prompts are those selected in the **Global-System** window earlier in this section.*

3. Use the arrow keys to enter a value for the *Low* end of the frequency output range and press [Enter].

**Note:** *A complete pulse consists of equal amounts of ON and OFF times. Choose a value that is compatible with the frequency counter to be used.*

4. Use the arrow keys to enter a value for the *High* end of the frequency output range and press [Enter].
5. Use the arrow keys to enter a value between 1 and 10,000 for the *Frequency* at full scale and press [Enter].

#### Procedure Options

After completing the above steps, the XGM868i returns to the I/O window. Do one of the following:

- To continue programming, refer to Appendix A, *Menu Maps*, to navigate to the desired menu.
- To leave the *Keypad Program*, press [Escape] three times.

### 1.9.3 Configuring the Communications Port

The Model XGM868i flowmeter is equipped with an RS232 or an RS485 serial interface. An RS485 option is also available with MODBUS capability. When the MODBUS option is installed, the XGM868i may still also have the standard RS232 serial interface.

The meter can be configured with a MODBUS option card for MODBUS communications, a Foundation Fieldbus option card for Foundation Fieldbus communications, an Ethernet option card for Ethernet communications, or with a MODBUS/TCP option card for MODBUS communication over the Ethernet, if desired.

**Note:** To set *Fieldbus communications parameters*, see *Appendix E, Foundation Fieldbus Communications*.

The serial port is used to transmit stored data and displayed readings to a personal computer by connecting the meter's serial interface to the serial port of the PC. In addition, the Model XGM868i can receive and execute remote commands, using *PanaView* software via this link.

Use the **COMM** submenu to set the communications port and MODBUS parameters. While programming the meter, refer to Figure 30 on page 71.

#### 1.9.3.1 Setting Up the Serial Port

Use the steps below to configure the communications port:

1. In the *Keypad Program*, scroll to PROG and press [Enter].
2. In the PROG menu, scroll to GLOBL and press [Enter].
3. In the Global PROGRAM menu, scroll to COMM and press [Enter].
4. Enter a *Meter Address* (between 1 and 127) and press [Enter]. (The default address is 1.)

A meter address is necessary for communication with the Panametrics *PanaView* software. See Appendix C, *Programming the XGM868i with PanaView™*, or the *PanaView™ User's Manual (910-211)* for more information.

**IMPORTANT:** If the meter address or baud rate is changed, communication with *PanaView* must be re-established with the new parameters.

5. Scroll to the desired *Baud Rate* and press [Enter]. (Available baud rates extend from 300 to 19,200.)
6. Do one of the following:
  - If you have the RS485 MODBUS option, proceed to Step 1 in *Setting Up MODBUS Communications* on the following page.
  - If you have the standard RS232 serial interface, go to *Procedure Options* on the next page.

### 1.9.3.2 Setting Up MODBUS Communications

When equipped with an optional MODBUS output card, the XGM868i can transmit flow data serially to a flow computer, or SCADA, using a Gould-type RTU protocol. Thus only the MODBUS function command, 3 (read multiple registers), 6 (write multiple registers) is valid. The XGM868i uses the following format for the data exchange:

- The *Send* command (initiated by the host flow computer or controller) comes in the form:  
[time delimiter]<Addr><3><First Register MSB>  
<First Register LSB> <Register Count MSB>  
<Register Count LSB><CRC Low><CRC High>[time delimiter]
- The *Response* (initiated by the host flow computer or controller) comes in the form:  
[time delimiter]<Addr><3><Byte count><Data.....>  
<CRC Low><CRC High>[time delimiter]

The format for the returned data types is:

- Integer (16 bit Integer) <MSB><LSB>  
1 Register - 16 bit integer
- Integer (32 bit Integer) <MSB><LSB><LSB><LSB>  
2 Register - 32 bit integer
- Floating Point (FP) <EXP><MAN><MAN><MAN>  
2 Registers - 32 bit IEEE floating point number

Use the steps below to configure MODBUS communications:

**IMPORTANT:** The XGM868i MODBUS communications settings chosen in the next four steps must match those of the MODBUS control system.

1. Scroll to the desired *MODBUS Baud Rate* and press [Enter].
2. Scroll to the *MODBUS Parity* and press [Enter].
3. Scroll to the *MODBUS Stop Bits* and press [Enter].
4. Enter a *MODBUS Meter Address* (between 1 and 254) and press [Enter]. (The default address is 1.)

**IMPORTANT:** You must reboot the XGM868i to load the new settings.

#### Procedure Options

After completing the above steps, the XGM868i returns to the Global PROGRAM window. Do one of the following:

- Refer to the section *Requesting Parameters Using MODBUS* on the following page to retrieve data from the XGM868i using MODBUS.
- To continue regular programming, refer to Appendix A, *Menu Maps*, to navigate to the desired menu.
- To leave the *Keypad Program*, press [Escape] three times.



### 1.9.4 Requesting Parameters Using MODBUS

To request specific parameters from the XGM868i via the MODBUS, the control system must enter the appropriate register number. Only registers 1 through 90 are available for MODBUS communications, while registers 508 through 512 are used by the XGM868i to store the MODBUS parameters. For details, see Table 11 for a 1-Channel meter or Table 12 on page 39 for a 2-Channel meter.

**Note:** If you request Channel2 or Averaged data from a 1-Channel meter, the values will all be zero.

**Table 11: MODBUS Registers for a 1-Channel XGM868i**

MODBUS Reg #	DPR Hex Addr	Description	Scaling (decimal places)	Size in Bytes
1	0	<sup>1</sup> "Clear Ch1 Totalizers"	--	2 (16 bit signed)
2	2	Not Used	--	2 (16 bit signed)
3	4	Velocity	2	4 (2 16-bit int)
5	8	Act Volumetric	#Q DIGITS	4 (IEEE 32 bit)
7	C	Std Volumetric	#Q DIGITS	4 (IEEE 32 bit)
9	10	Fwd Totals	#T DIGITS	4 (2 16 bit int)
11	14	Rev Totals	#T DIGITS	4 (2 16 bit int)
13	18	#Tot Digits	0	2
14	1A	Mass Flow	#M DIGITS	4 (IEEE 32 bit)
16	1E	Fwd Mass Totals	#MT DIGITS	4 (2 16-bit int)
18	22	Rev Mass Totals	#MT DIGITS	4 (2 16-bit int)
20	26	#Mass Tot Digits	0	2
21	28	Timer	2	4 (2 16-bit int)
23	2C	Error Code	0	2
24	2E	Sound Speed	3	4 (2 16-bit int)
26	32	Density	4	4 (2 16-bit int)
28	36	Signal Strength Upstream	1	4 (2 16-bit int)
30	3A	Signal Strength Downstream	1	4 (2 16-bit int)
32	3E	Temperature	2	4 (2 16-bit int)
34	42	Pressure	3	4 (2 16-bit int)
508	3F6	<sup>2</sup> MODBUS baud rate	0	2
509	3F8	<sup>3</sup> MODBUS parity	0	2
510	3FA	<sup>4</sup> MODBUS stop bits	0	2
511	3FC	MODBUS meter addr	0	2
512	3FE	RESERVED	---	---

**Table 12: MODBUS Registers for a 2-Channel XGM868i**

MODBUS Reg #	DPR Hex Addr	Description	Scaling (decimal places)	Size in Bytes
1	0	<sup>1</sup> "Clear Ch1 Totalizers"	--	2 (16 bit signed)
2	2	<sup>1</sup> "Clear Ch2 Totalizers"	--	2 (16 bit signed)
3	4	Ch1 Velocity	2	4 (2 16-bit int)
5	8	Ch1 Act Volumetric	#Q DIGITS	4 (IEEE 32 bit)

**Table 12: MODBUS Registers for a 2-Channel XGM868i**

7	C	Ch1 Std Volumetric	#Q DIGITS	4 (IEEE 32 bit)
9	10	Ch1 Fwd Totals	#T DIGITS	4 (2 16 bit int)
11	14	Ch1 Rev Totals	#T DIGITS	4 (2 16 bit int)
13	18	Ch1 #Tot Digits	0	2
14	1A	Ch1 Mass Flow	#M DIGITS	4 (IEEE 32 bit)
16	1E	Ch1 Fwd Mass Totals	#MT DIGITS	4 (2 16-bit int)
18	22	Ch1 Rev Mass Totals	#MT DIGITS	4 (2 16-bit int)
20	26	Ch1 #Mass Tot Digits	0	2
21	28	Ch1 Timer	2	4 (2 16-bit int)
23	2C	Ch1 Error Code	0	2
24	2E	Ch1 Sound Speed	3	4 (2 16-bit int)
26	32	Ch1 Density	4	4 (2 16-bit int)
28	36	Ch1 Sig Strength Upstream	1	4 (2 16-bit int)
30	3A	Ch1 Sig Strength Downstream	1	4 (2 16-bit int)
32	3E	Ch1 Temperature	2	4 (2 16-bit int)
34	42	Ch1 Pressure	3	4 (2 16-bit int)
36	46	Ch2 Velocity	2	4 (2 16-bit int)
38	4A	Ch2 Act Volumetric	#Q DIGITS	4 (IEEE 32 bit)
40	4E	Ch2 Std Volumetric	#Q DIGITS	4 (IEEE 32 bit)
42	52	Ch2 Fwd Totals	#T DIGITS	4 (2 16 bit int)
44	56	Ch2 Rev Totals	#T DIGITS	4 (2 16 bit int)
46	5A	Ch2 #Tot Digits	0	2
47	5C	Ch2 Mass Flow	#M DIGITS	4 (IEEE 32 bit)
49	60	Ch2 Fwd Mass Totals	#MT DIGITS	4 (2 16-bit int)
51	64	Ch2 Rev Mass Totals	#MT DIGITS	4 (2 16-bit int)
53	68	Ch2 #Mass Tot Digits	0	2
54	6A	Ch2 Timer	2	4 (2 16-bit int)
56	6E	Ch2 Error Code	0	2
57	70	Ch2 Sound Speed	3	4 (2 16-bit int)
59	74	Ch2 Density	4	4 (2 16-bit int)
<b>MODBUS Reg #</b>	<b>DPR Hex Addr</b>	<b>Description</b>	<b>Scaling (decimal places)</b>	<b>Size in Bytes</b>
61	78	Ch2 Sig Strength Upstream	1	4 (2 16-bit int)
63	7C	Ch2 Sig Strength Downstream	1	4 (2 16-bit int)
65	80	Ch2 Temperature	2	4 (2 16-bit int)
67	84	Ch2 Pressure	3	4 (2 16-bit int)
69	88	Avg Velocity	2	4 (2 16-bit int)
71	8C	Avg Act Volumetric	#Q DIGITS	4 (IEEE 32 bit)
73	90	Avg Std Volumetric	#Q DIGITS	4 (IEEE 32 bit)
75	94	Avg Fwd Totals	#T DIGITS	4 (2 16 bit int)
77	98	Avg Rev Totals	#T DIGITS	4 (2 16 bit int)
79	9C	Avg #Tot Digits	0	2

**Table 12: MODBUS Registers for a 2-Channel XGM868i**

80	9E	Avg Mass Flow	#M DIGITS	4 (IEEE 32 bit)
82	A2	Avg Fwd Mass Totals	#MT DIGITS	4 (2 16-bit int)
84	A6	Avg Rev Mass Totals	#MT DIGITS	4 (2 16-bit int)
86	AA	Avg #Mass Tot Digits	0	2
87	AC	Avg Timer	2	4 (2 16-bit int)
89	B0	<sup>5</sup> Avg Error Code	0	2
90	B2	Avg Sound Speed	3	4 (2 16-bit int)
508	3F6	<sup>2</sup> MODBUS baud rate	0	2
509	3F8	<sup>3</sup> MODBUS parity	0	2
510	3FA	<sup>4</sup> MODBUS stop bits	0	2
511	3FC	MODBUS meter addr	0	2
512	3FE	RESERVED	---	---

**1.9.4.1 Notes:**

- 1. Clear Totalizers:**  
flag from the 8051 to clear either the Channel 1 or Channel 2 totalizers.
- 2. MODBUS baud rate:**  
5 = 2400, 6 = 4800, 7 = 9600
- 3. MODBUS parity:**  
0 = none, 1 = odd, 2 = even
- 4. MODBUS stop bits:**  
1 = 1 stop bit, 2 = 2 stop bits
- 5. AVG Error Code:**  
0=Both Ch1 and Ch2 are in error.  
1=Ch1 only is in error  
2=Ch2 only is in error  
3=Both channels are error free

**1.9.5 Activating Security**

In order to prevent unauthorized tampering with the flowmeter's programming, the XGM868i is equipped with a security feature that locks all the keys except [PROG] (which, when pressed, requires the password).

When the system is locked, access to the menus will be denied unless the correct password is entered. The XGM868i is shipped with a default password (2719 and three spaces). For increased security, the default password should be changed.

**IMPORTANT:** Once the system has been locked, it can only be unlocked by entering the password, because access to the SECUR submenu is restricted.

While following the programming instructions, refer to the menu map in Figure 30 on page 71.

**IMPORTANT:** It is recommended that all program parameters be recorded before changing the password. (This information should be recorded in Appendix B, Data Records, as a matter of routine.) If the password is lost, the site data is not retrievable and will have to be re-entered.

- 1.** In the *Keypad Program*, scroll to **PROG** and press [Enter].
- 2.** From the **PROGRAM** menu, scroll to **GLOBL** and press [Enter].
- 3.** Scroll to **SECUR** and press [Enter].
- 4.** At the Lock Out prompt, scroll to **UNick** to unlock the system and return to the initial **PROGRAM** menu, or scroll to **LOCK** to lock the system.

**Note:** If the system was unlocked at the above prompt, the following steps do not appear.

5. Enter the current or default Password and press **[Enter]**.
6. At the Edit Password prompt, scroll to **NO** and press **[Enter]** to leave the password unchanged, or scroll to **YES** to enter a new password.

**IMPORTANT:** Since the default password is printed in this manual, a new password should be entered. If the password is ever lost, contact the factory for assistance.

7. Enter the New Password and press **[Enter]**. Any combination of letters and numbers up to a total of 7 characters may be used as a password.
8. Verify the New Password by entering it again and press **[Enter]**. Be sure to record the new password in a safe place.

## 1.10 Exiting the User Program

After completing the **COMM** option, the XGM868i returns to the **Global PROGRAM** prompt. Press **[Escape]** twice to return to the *Keypad Program*, and a third time to return to the meter display. Then proceed to Chapter 3, *Operation*, of the *Startup Guide* for instructions on taking measurements, or refer to the appropriate chapters of this manual for detailed instructions on using the other features of the XGM868i flow transmitter.

## Chapter 2. Displaying Data

### 2.1 Introduction

This chapter explains how to display measurement data using either of the available methods:

- **LCD Display** - show data on the built-in display
- **PanaView** - display data on a computer terminal using the optional PanaView software

### 2.2 Displaying Data with the LCD

When equipped with the Liquid Crystal Display (LCD), the Model XGM868i may be programmed to display up to four variables in sequence. In addition, the contrast of the LCD may be adjusted for optimum viewing. Proceed to the appropriate section for instructions, and refer to Figure 30 on page 71 of Appendix A, *Menu Maps*.

#### 2.2.1 Adjusting LCD Contrast

The LCD contrast may be adjusted through the *Keypad Program* to suit individual needs.

1. Press [Escape], [Enter], [Escape].
2. In the *Keypad Program* window, scroll to CNTRS and press [Enter].
3. Scroll to *DARKN* or *LITEN* and press [Enter] until the screen shows the desired contrast.
4. When you have achieved the desired contrast, scroll to *STORE* to retain the setting, or to *ABORT* to leave the menu without changing the setting. In either case, the XGM868i returns to the *Keypad Program*.
5. Then press [Escape] to return to the display screen.

#### 2.2.2 Programming the LCD

**Note:** When you first initialize the XGM868i, the number of LCD parameters is set to OFF. You must program the LCD to display any measured parameters.

Through the *Keypad Program*, you can program the LCD display to display up to four variables in sequence. Complete the following steps to program the LCD display:

1. Power up the XGM868i and wait until it has initialized.
2. Press [Escape], [Enter], [Escape].
3. In the *Keypad Program* window, scroll to PROG and press [Enter].
4. In the PROG menu, scroll to GLOBL and press [Enter].
5. Scroll to I/O and press [Enter].
6. Scroll to LCD and press [Enter].
7. The window now asks for the # of LCD Parameters. Scroll to the desired number (from OFF through 1-4 and KEY) and press [Enter].

The OFF setting switches the measurement display off, while the KEY setting enables users to change the measurement display via the arrow keys, without accessing the *Keypad Program*. If you select KEY:

- To view a different parameter, press the [◀] or [▶] keys to scroll through the various parameters.
- To scroll through the channel options on a two-channel XGM868i, press the [△] or [▽] keys until you have reached the desired option.

For a 1-Channel XGM868i, the data for Channel 1 is displayed automatically, and you can skip to step 9. However, for a 2-Channel meter, the channel data to be displayed must be specified at the following prompt.

## 2.2.2 Programming the LCD (cont.)

8. Scroll to the desired *Channel option*, as listed in Table 13.

**Table 13: Channel Options**

Option	Description
CH1	Channel 1
CH2	Channel 2
SUM	CH1+CH2
DIF	CH1-CH2
AVE	$(CH1+CH2)/2$

9. For each channel, select the desired *Measurement Parameter*, as shown in Table 9 on page 26.

**Note:** *The measurement units that appear in these prompts are those selected in the **GLOBL-SYSTEM** menu earlier in this manual. Also, when differences in one channel's programming invalidate an output previously chosen for the other, the measurement defaults to the nearest selectable item in the parameter list.*

The previous two prompts repeat until all of the specified **# of LCD Parameters** have been set up. When all of the display parameters have been set up, the meter returns to the **Global I/O** window. To leave the *Keypad Program*, press the **[Escape]** key three times.

After leaving the *Keypad Program*, the XGM868i will reset itself and will begin to display the parameters specified in this section. If more than one parameter was set up, each of the parameters will be displayed in sequence, with a pause of several seconds between display changes.

## 2.3 Displaying Data on a Computer Terminal

The flow rate data collected by the XGM868i may be displayed in various formats on a remote computer terminal via the meter's RS232 serial port. This requires the use of the optional PanaView software. Refer to the instructions below to display data via PanaView.

### 2.3.1 Preparing for PanaView Programming

Before you attempt to communicate with the XGM868i, be sure you have linked your PC to the XGM868i via an RS232 interface. For details on wiring the interface, refer to *Wiring the Serial Port* in the *Startup Guide*, and to the document *EIA-RS Serial Communications (916-054)*. You must also install PanaView, as discussed in the *PanaView User's Manual (910-211)*, and in Appendix C, *Programming the XGM868i via PanaView™*.

1. Power up the XGM868i and wait until it has initialized.
2. Launch PanaView and wait until it initializes the XGM868i and displays the basic PanaView window.
3. As described in Appendix C, open the *Meter Browser* window and highlight the meter to be used.

At this time, any of PanaView's comprehensive data handling capabilities may be used. These include:

- collecting and displaying live data in text format
- collecting and displaying live data in graphical format
- collecting and logging live data
- displaying a log file in text format
- displaying a log file in graphical format

To access PanaView's data handling options, pull down the *Output* menu, as shown in Figure 2.

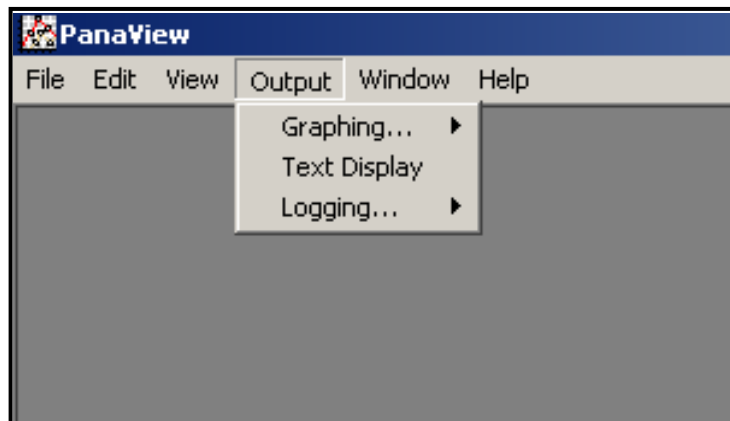

**Figure 2: Output Menu**

## 2.3 Displaying Data on a Computer Terminal (cont.)

Proceed directly to the appropriate section for instructions on either of the following output options:

- *Text Display* output, discussed below
- *Graphing* output on page 43

**Note:** For information on the Logging output, see Chapter 3, Logging Data.

### 2.3.1 The Text Display Output

To collect data from the instrument and display it on a text screen, complete the following steps:

1. Complete Steps 1-3 on the previous page.
2. Pull down the *Output* menu and click on the *Text Display* option (see Figure 2 on page 39).

**Note:** The *Text Display* window that appears after Step 2 is actually stacked on top of any previously opened windows (such as the *Meter Browser* window).

3. Using the *Window* menu, arrange the open windows in the desired format. For this discussion, Figure 3 shows the *Text Display* window in its maximized (full-screen) size.

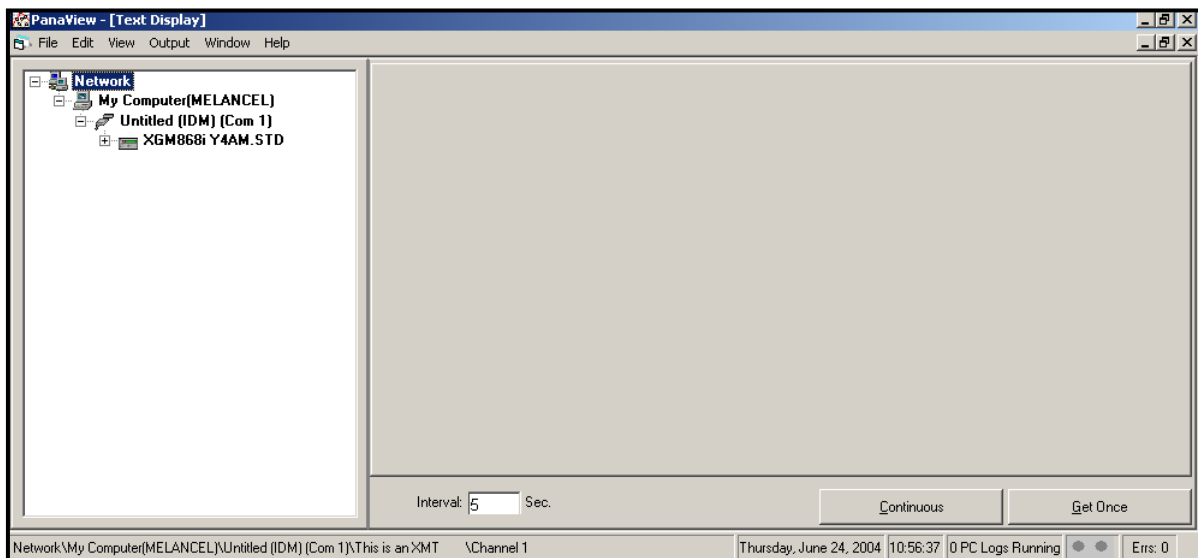

**Figure 3: Text Display Window**

**Note:** Figure 3 has been compressed both vertically and horizontally for improved clarity.



### 2.3.1 The Text Display Output (cont.)

4. The left pane of the *Text Display* window contains the standard PanaView network tree. Expand this tree as far as necessary, and double click on the desired process parameter to display it in the right pane of the window.
5. Before actual data values can be displayed in the text pane, activate one of the following data collection modes (refer to Figure 3 on page 40):
  - Click on the **[Get Once]** option button at the bottom of the right pane in the *Text Display* window. The current value of the selected process parameter, as specified in the PanaView network tree, is displayed in the right pane of the *Text Display* window.

or

- Enter an *interval* in the text box at the bottom of the right pane in the *Text Display* window, or check the *Max. Comm Rate* box to collect readings as fast as the system allows (1 sec). Then, click on the **[Continuous]** option button to begin collecting data for display in the right pane of the *Text Display* window.

**Note:** Any value entered in the Interval text box is overridden if the Max. Comm Rate box is checked.

6. If the **[Continuous]** option was selected in Step 5 above, click on the **[Stop]** option button, which has replaced the original **[Continuous]** option button, to terminate data collection.

The *Text Display* window may be left open while other tasks are performed, or it may be closed by clicking on the lower **[X]** control button at the far right of the menu bar.

**IMPORTANT:** If you click on the upper **[X]** control button at the far right of the PanaView title bar, you will exit PanaView completely.

### 2.3.1.1 Displaying Multiple Process Parameters

The procedure for displaying a single process parameter in a text screen may be repeated to simultaneously display multiple process parameters. To do so, proceed as follows:

1. Display the first process parameter in a text screen, as described in the previous section.
2. Repeat Step 1 for any desired additional process parameters, by double clicking on them in the PanaView network tree. PanaView automatically tiles the multiple text screens in the right pane of the *Text Display* window.
3. As in any standard Windows application, the multiple text screens may be resized by dragging their borders. Also, the individual panes within a parameter's text screen may be resized by dragging the borders within that text screen.
4. To close an open text screen, right click anywhere within that screen (except in the title bar or the error section) and click on the **[Remove]** option that pops up in the context menu.

**Note:** *After resizing or removing any of the multiple text screens, the default tiled layout may be restored by opening the "Window" menu (see the PanaView User's Manual) and clicking on the "Tile Output Displays" option.*

### 2.3.1.2 Displaying Multiple Text Windows

The procedures for displaying one or more process parameters in a single *Text Display* window may be repeated to open multiple *Text Display* windows. To do so, proceed as follows:

1. To open another *Text Display* window, repeat the steps on page 40 and page 41.
2. To display the desired process parameter(s) in the new window, repeat Steps 1-4 on page 42.
3. Arrange the multiple *Text Display* windows as desired via the *Window* menu.

## 2.3.2 The Graphing Output

To collect data from the instrument and display it graphically in a new format, complete the following steps:

### 2.3.2.1 Setting Up a Graph

1. Perform Steps 1-3 on page 37.

2. Pull down the *Output* menu and click on the *Graphing - New* option (see Figure 2 on page 39).

**Note:** The *Graph window* is stacked on top of any previously opened windows (such as the *Meter Browser window*).

3. Using the *Window* menu, arrange the open windows in the desired format. For this discussion, Figure 4 shows the *Graph window* in its maximized (full-screen) size.

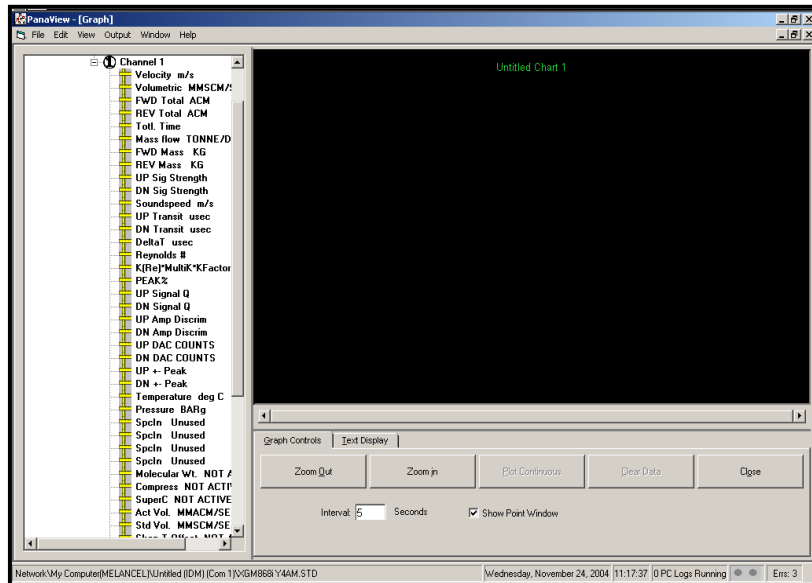

**Figure 4: Graph Window**

The *Graph window* shown above consists of three panes:

- *left pane* - PanaView network tree
- *top right pane* - graph with default chart style
- *bottom right pane* - graph controls or text display

**Note:** The three panes of the *Graph window* may be resized by simply dragging their borders.

### 2.3.2.2 Graphing Data

The PanaView network tree has already been described, and the display pane shows only a graph in the default style with no data points. The bottom right pane enables you to set up the graph. To begin graphing your data, proceed as follows:

1. Expand the network tree as far as necessary and double click on the process parameter to be graphed. The grid for the selected graph appears in the display pane, with *Time* as the x-axis and the parameter *Value* as the y-axis. In addition, a *legend* appears above the graph, which indicates the name, data point shape and line color for that parameter.
2. If desired, a second parameter may be added to the graph by repeating Step 1. In this case, the parameter “*Value*” is shown as a *right y-axis (Y2)*.

**Note:** *Although only two parameters may be graphed for any one meter channel, the same two parameters may also be graphed for any other active meter channels.*

3. To begin plotting data for the selected parameter(s), enter a time *Interval* for data sampling in the text box provided (the default value is 5 seconds).
4. Click on the **[Plot Continuous]** control button to begin graphing the selected process parameter(s) as a function of time, at the interval specified in Step 3.
5. While PanaView is graphing the data, the following actions may be taken from the control pane:
  - change the sampling interval by entering a new value
  - click on the **[Zoom Out]** control button to increase the size of the intervals shown on the x-axis
  - click on the **[Zoom In]** control button to decrease the size of the intervals shown on the x-axis

**Note:** *The zoom buttons may be clicked multiple times to enhance the effect.*

- click on the *Text Display* tab to view the data being graphed in the text format described in the previous section

When you have finished graphing your data, click on the **[Stop]** control button, which has replaced the original **[Plot Continuous]** control button.

For further information on setting up graph properties, refer to Chapter 5, *Displaying Data*, of the *PanaView User's Manual*.

### 2.3.3 Displaying Transducer Signals

Along with flow rate data, PanaView enables XGM868i users to read and plot transducer signals from the XGM868i.

1. From the *New Meter Browser*, highlight the XGM868i.
2. Right-click on the highlighted XGM868i and click on the *Properties* option, as shown in Figure 5.

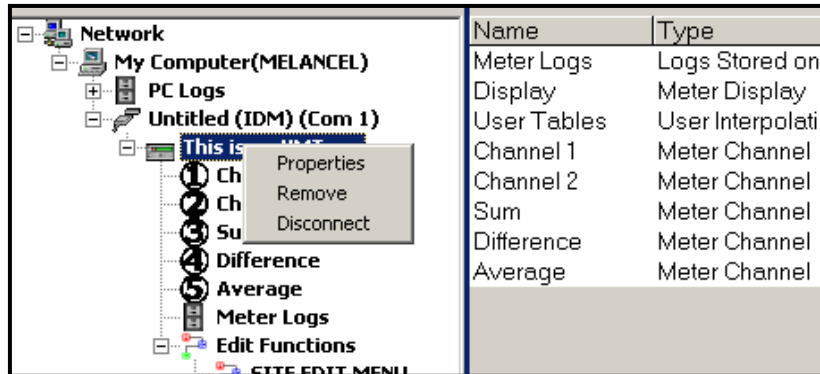

Figure 5: *Properties* Option in the *New Meter Browser*

The *Properties* window opens, as shown in Figure 6.

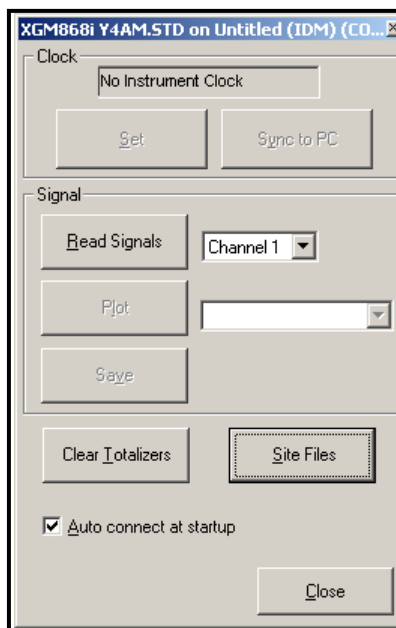
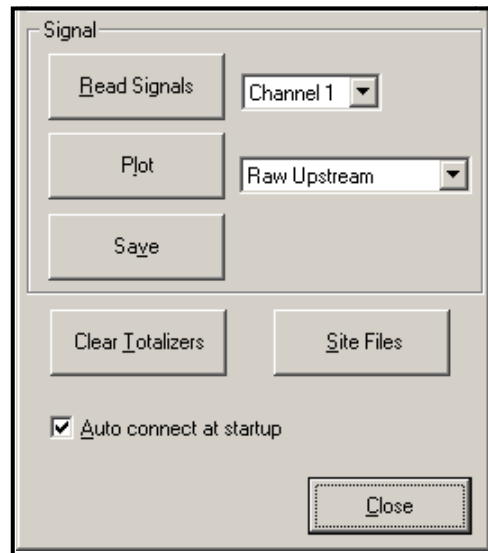

Figure 6: *Properties* Window

### 2.3.3.1 Reading Transducer Signals

- To read a signal from the meter, click on the [Read Signals] button. (If the meter is a multi-channel instrument, open the Channel drop-down menu and click on the desired channel.) After a moment, the *Properties* window appears similar to Figure 7.

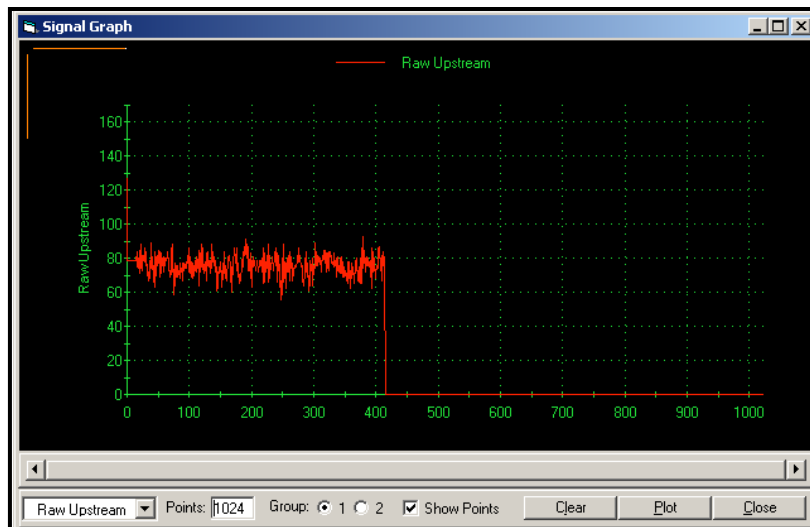

**Figure 7: Active Signal Options**

- To select a different signal type, open the signal menu at the right (shown here with *Raw Upstream* highlighted) and click on the desired signal.

### 2.3.3.2 Plotting Transducer Signals

To plot the selected signal, click on [Plot]. A graphical window opens, as shown in Figure 8.



**Figure 8: Signal Graph Window**

### 2.3.3.3 Saving Transducer Signals

To save the raw signal, click on [Save]. A window opens similar to Figure 9. Enter the desired name, and click on [Save] to save the signal as a text file.

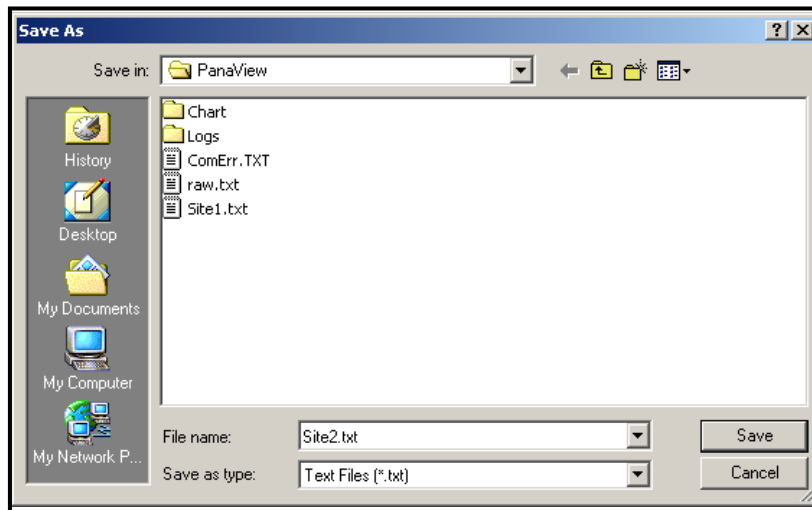

**Figure 9: Save As Window**

[no content intended for this page]



## Chapter 3. Logging Data

### 3.1 Introduction

The XGM868i offers two options for logging data:

- If the Model XGM868i flowmeter is equipped with an optional *data logging card* in **Slot 2**, flow rate data can be recorded and stored in this memory in the form of a *log file*. After the specified data has been logged, the log file may be uploaded to PanaView via the RS232 link.
- PanaView can also create *PC log files* for storage on the PC's hard drive.

This chapter explains how to use the Model XGM868i's data logging capability with PanaView.

### 3.2 Data Logging Option Card

In order to log data, the Model XGM868i must be fitted with an optional data logging option card in **Slot 2**. See Chapter 4, *Parts Replacement*, of the *Service Manual* for instructions on installing the card.

### 3.3 Logging with PanaView

PanaView is capable of creating and viewing log files of the following types:

- **meter logs** – log files stored in the XGM868i memory, as discussed above
- **PC logs** – log files stored on your PC's hard drive (see page 54)

To create or view logs of the above types, proceed to the appropriate section of this chapter.

### 3.4 Creating Meter Logs

To create a new meter log, complete the following steps:

1. From the *New Meter Browser* in PanaView, expand the network tree and open the *Edit Functions* option (described in Appendix C, *Programming the XGM868i via PanaView*). The menu will appear similar to Figure 10.

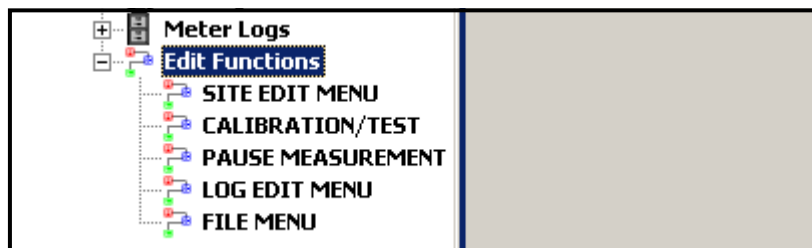

Figure 10: Edit Functions Menu for XGM868i with Logging Card

2. Double-click on the *Log Edit Menu*, as shown in Figure 10. The window appears similar to Figure 11.

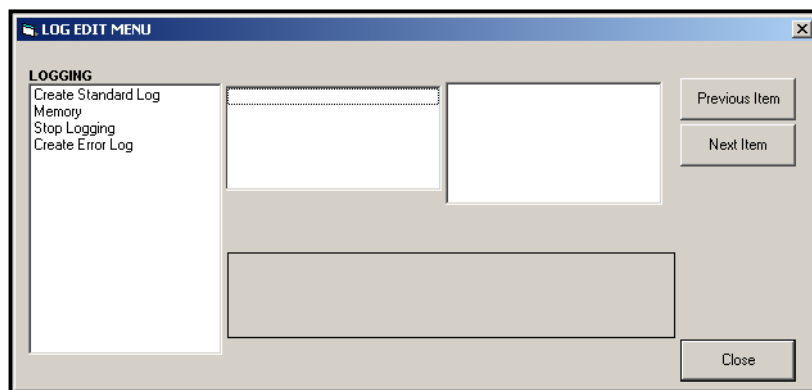
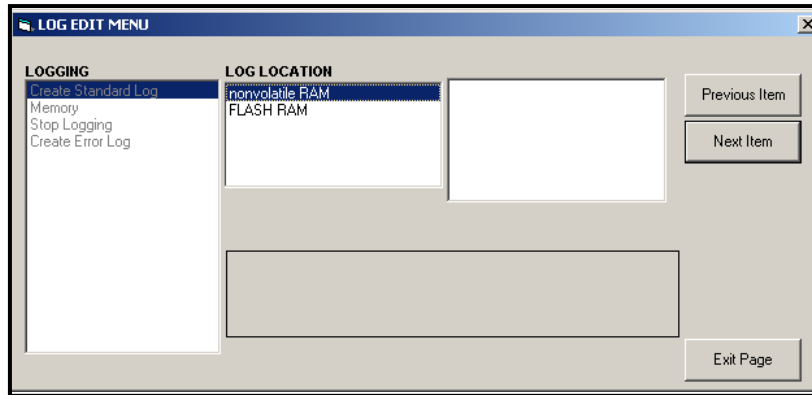

Figure 11: Log Edit Menu Window

### 3.4.1 Creating a Standard Meter Log

3. To create a standard meter log, complete the following steps:
  - a. Double-click on the *Create Standard Log* option. The window now appears similar to Figure 12.



**Figure 12: Log Location in the Create Standard Log Option**

- b. PanaView first asks for the *Log Location*, either flash or non-volatile RAM. Double-click on the desired location.
- c. Now type the desired *Log Name* in the right window, and click **[Next Item]**.
- d. Type the desired *Log Message* in the right window, and click **[Next Item]**.
- e. PanaView now asks for the *Number of Variables* you wish to log. Type in the desired number (from 1 to 6), and click **[Next Item]**.
- f. Double-click on the desired *Channel* for the first variable.
- g. Scroll to and double-click on the desired *Measurement* to be logged.
- h. Repeat steps f and g for the specified number of variables.
  - If you select a forward or reverse total, PanaView asks if you want to *Reset Totals to 0?* Double-click on *Yes* or *No*.
- i. PanaView indicates a given *StartTime*. Double-click on *OK* to agree to the given time, on *Now* to start the log immediately, or on *Edit* to change the starting time.
  - If you select *Edit*, PanaView asks first for the desired *Hour*, then for the *Minute*, and finally for the *Second*. For each parameter, type the desired number in the right window, and click **[Next Item]** (or simply click **[Next Item]** to step through the parameters).

### 3.4.1 Creating a Standard Meter Log (cont.)

- j.** PanaView indicates a given *StartDate*. Double-click on *OK* to agree to the given day, on *Today* to start the log that day, or on *Edit* to change the starting date.
  - If you select *Edit*, PanaView asks first for the desired *Year*, then for the *Month*, and finally for the *Day*. For each parameter, type the desired number in the right window, (or scroll to and click on the desired month) and click **[Next Item]** (or simply click **[Next Item] to step through the parameters**).
- k.** PanaView indicates a given *End Time*. Double-click on *OK* to agree to the given time, on *Now* to start the log immediately, or on *Timed* to indicate a specific duration.
  - If you select *Edit*, PanaView asks first for the desired *Hour*, then for the *Minute*, and finally for the *Second*. For each parameter, type the desired number in the right window, and click **[Next Item]** (or simply click **[Next Item] to step through the parameters**).
  - If you select *Timed*, PanaView asks for the *Log Time* (duration). Scroll to and double-click on the desired length of time (from 10 minutes to 24 hours.) Then go to step m.
- l.** PanaView indicates a given *End Date*. Double-click on *OK* to agree to the given day, on *Today* to start the log that day, or on *Edit* to change the starting date.
  - If you select *Edit*, PanaView asks first for the desired *Year*, then for the *Month*, and finally for the *Day*. For each parameter, type the desired number in the right window, (or scroll to and click on the desired month) and click **[Next Item]** (or simply click **[Next Item] to step through the parameters**).
- m.** Scroll to and double-click on the desired *Time Increment* (from 5 seconds to 24 hours). PanaView indicates that the log has been created, and returns to the *Log Edit Menu*.

If an erroneous value has been entered, PanaView displays a *Log Creation Error* message. Otherwise, the program indicates that the log has been created, and returns to the *Log Edit Menu*.

### 3.4.2 Creating an Error Log

To create an error meter log, complete the following steps:

- 1.** Double-click on the *Create Error Log* option.
  - a.** PanaView first asks for the *Log Location*, either flash or non-volatile RAM. Double-click on the desired location.
  - b.** Now type the desired *Log Name* in the right window, and click **[Next Item]**.
  - c.** Type the desired *Log Message* in the right window, and click **[Next Item]**.
  - d.** PanaView now asks for the *Number of Variables* you wish to log. Type in the desired number (from 1 to 6), and click **[Next Item]**.
  - e.** Double-click on the desired *Channel* for the first variable.
  - f.** Scroll to and double-click on the desired *Measurement*.
  - g.** Repeat steps e and f for the specified number of variables.
    - If you select a forward or reverse total, PanaView asks if you want to *Reset Totals to 0*? Double-click on *Yes* or *No*.
  - h.** PanaView asks, *Is Log Circular?* Double-click on *Yes* or *No*.
  - i.** PanaView indicates a given *StartTime*. Double-click on *OK* to agree to the given time, on *Now* to start the log immediately, or on *Edit* to change the starting time.
    - If you select *Edit*, PanaView asks first for the desired *Hour*, then for the *Minute*, and finally for the *Second*. For each parameter, type the desired number in the right window, and click **[Next Item]** (or simply click **[Next Item] to step through the parameters**).
  - j.** PanaView indicates a given *StartDate*. Double-click on *OK* to agree to the given day, on *Today* to start the log that day, or on *Edit* to change the starting date.
    - If you select *Edit*, PanaView asks first for the desired *Year*, then for the *Month*, and finally for the *Day*. For each parameter, type the desired number in the right window, (or scroll to and click on the desired month) and click **[Next Item]** (or simply click **[Next Item] to step through the parameters**).

### 3.4.2 Creating an Error Log (cont.)

**Note:** If you have selected a circular log, PanaView now indicates that the log has been created, and returns to the Log Edit Menu.

- k. PanaView indicates a given *End Time*. Double-click on *OK* to agree to the given time, on *Now* to start the log immediately, or on *Timed* to indicate a specific duration.
  - If you select *Edit*, PanaView asks first for the desired *Hour*, then for the *Minute*, and finally for the *Second*. For each parameter, type the desired number in the right window, and click **[Next Item]** (or simply click **[Next Item] to step through the parameters**).
  - If you select *Timed*, PanaView asks for the *Log Time* (duration). Scroll to and double-click on the desired length of time (from 10 minutes to 24 hours.) Then go to step m.
- l. PanaView indicates a given *End Date*. Double-click on *OK* to agree to the given day, on *Today* to start the log that day, or on *Edit* to change the starting date.
  - If you select *Edit*, PanaView asks first for the desired *Year*, then for the *Month*, and finally for the *Day*. For each parameter, type the desired number in the right window, (or scroll to and click on the desired month) and click **[Next Item]** (or simply click **[Next Item] to step through the parameters**).
- m. Scroll to and double-click on the desired *Time Increment* (from 5 seconds to 24 hours). PanaView indicates that the log has been created, and returns to the *Log Edit Menu*.

If an erroneous value has been entered, PanaView displays a *Log Creation Error* message. Otherwise, the program indicates that the log has been created, and returns to the *Log Edit Menu*.

#### 3.4.2.1 Checking Log Memory

To check on the amount of log memory available, double-click on the *Memory* option in the *Log Edit Menu*. The right window indicates the number of bytes available in both NVR and Flash memory.

#### 3.4.2.2 Stop Logging

To manually terminate logging, double-click on the *Stop Logging* option in the *Log Edit Menu*. PanaView displays the name of the currently active logs. Double-click on your choice, and then click on *Yes* when the program asks if you wish to stop logging.

### 3.5 Creating PC Logs

PC logs are created in a different menu from the meter logs described in the last section. To create a new PC log:

1. Open the *Output* menu (see Figure 13), and click on the *Logging* option.

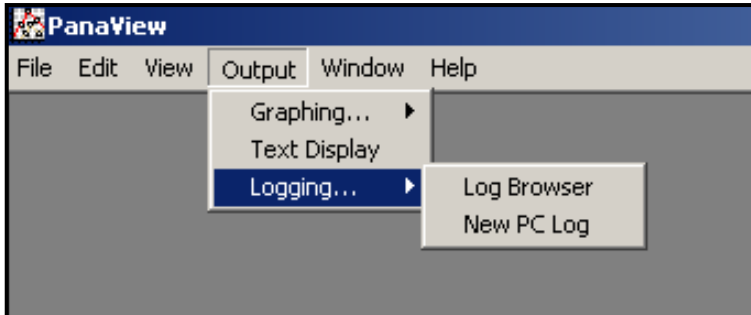

**Figure 13: Selections in the Logging Option**

You have two choices:

- Click on the *New PC Log* option and proceed to step 5, or
- Click on the *Log Browser* option. The dialog box shown in Figure 14 appears.

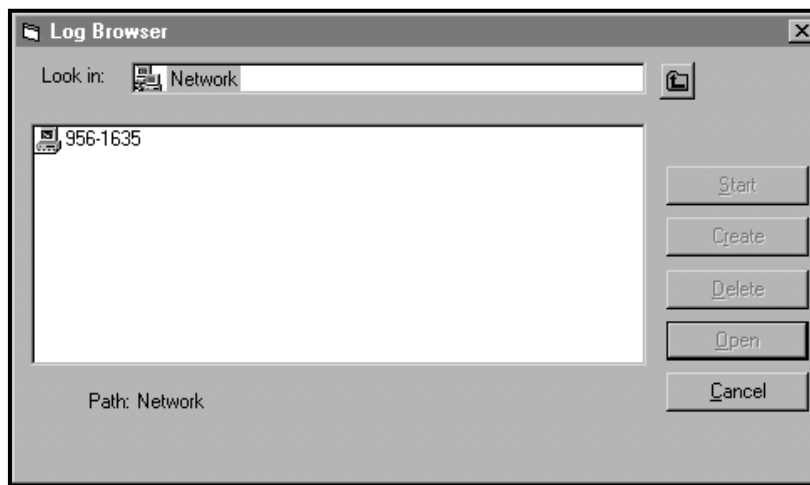
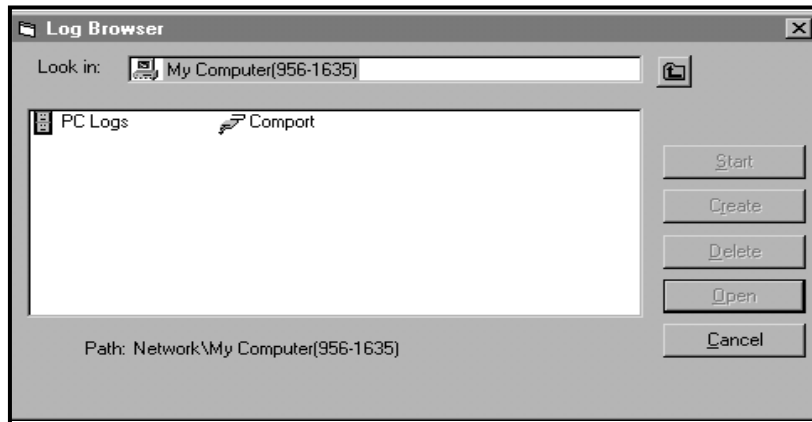

**Figure 14: Computer Selection**

**Note:** If no log files have yet been created or if a log file has not yet been selected from the list, all of the option buttons (except for **Cancel**) in the Log Browser dialog box are unavailable.

### 3.5 Creating PC Logs (cont.)

2. Double click on the *computer name* to advance to the dialog box shown in Figure 15.



**Figure 15: Log Type Selection**

3. Double click on *PC Logs* to advance to the dialog box shown in Figure 16.

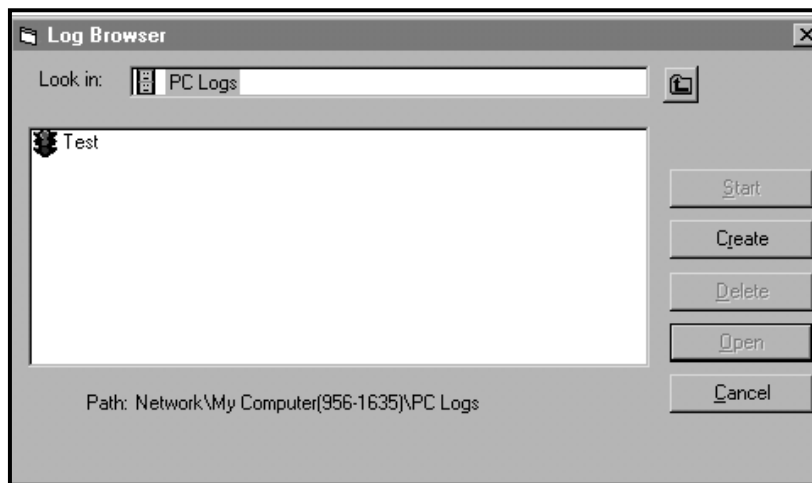

**Figure 16: Create a PC Log**

4. At the dialog box shown in Figure 16, click on the **[Create]** option button to create a new meter log.

### 3.5 Creating PC Logs (cont.)

5. Enter a log *file name* (“Sample” in this case) in the dialog box shown in Figure 17. Click on the **[OK]** option button.

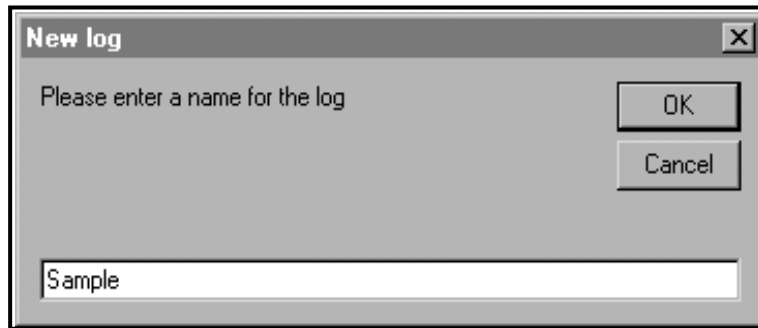

Figure 17: Log Name Dialog Box

6. At the resulting *PC Log* window shown in Figure 18, place a check mark in the text box to create a *circular log*, or leave this box empty to create a *linear log*.

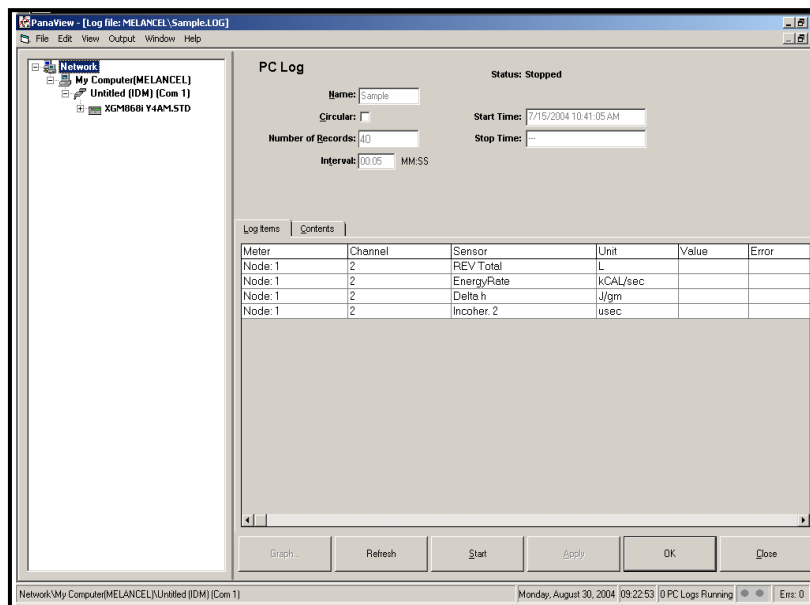

Figure 18: PC Log Window

7. Enter a sampling *interval* in the text box shown in Figure 18.

**Note:** Start Time and Stop Time cannot be specified for PC logs. These options are inactive in the PC Log window.

8. Expand the network tree as far as necessary and double click on the process parameter(s) to be logged. As they are selected, the parameters are listed in the lower right pane of the *PC Log* window (make sure that the *Log Items* tab in this pane is selected).

**Note:** To add all the channel parameters to a given log, right-click on the desired channel. A pop-up button, “Add Group to Log,” appears. Click on the button, and PanaView adds the entire set of channel parameters to the log.

9. Click on the **[Apply]** option button to record the log setup information, and then click on the **[Start]** option button to begin logging data immediately. (The *Start Time* automatically appears in the *PC Log* window.)



### 3.6 Viewing Meter Log Files

After one or more meter log files have been created, the logs may be viewed by using the *New Meter Browser*:

1. From the *New Meter Browser* in PanaView, expand the network tree and click on the *Meter Logs* option. If you have created one or more logs, the tree will appear similar to Figure 19.

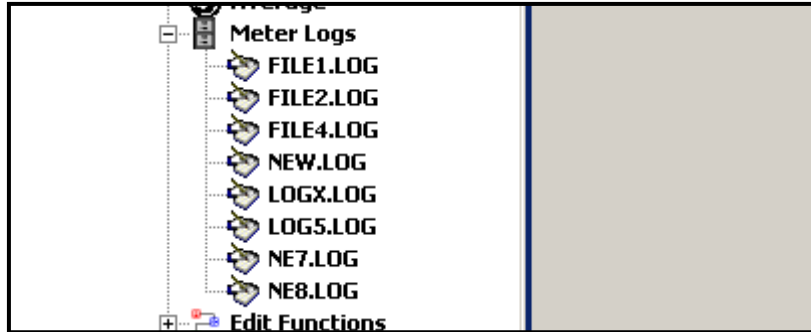

Figure 19: Expanded Meter Logs Option

2. Double-click on the desired log. A window opens for the individual log, as shown in Figure 20.

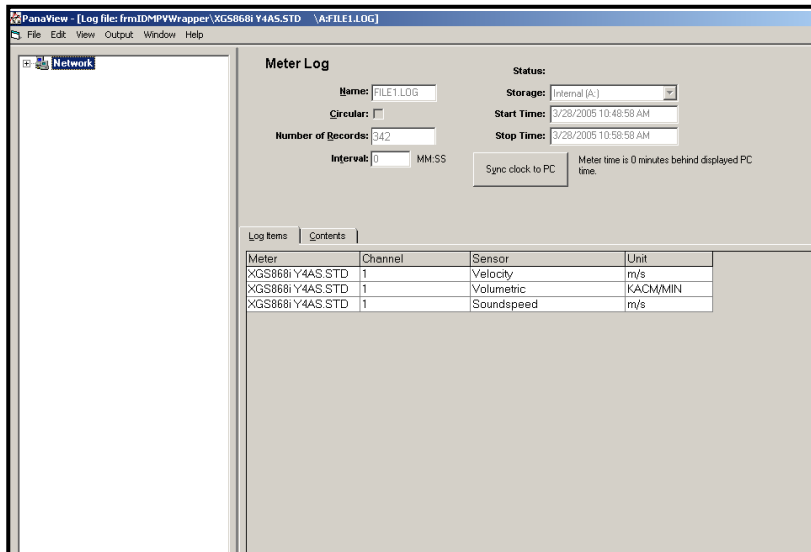

Figure 20: Data Window for an Individual Meter Log

- Click on the *Log Items* tab (see Figure 20) for a list of the parameters specified for logging.
- Click on the *Contents* tab (see Figure 21 on page 58) for a list of all the data points logged to date for the parameter currently highlighted on the *Log Items* tab.
- Click on the **[Graph]** option button to display a graphical representation of the data logged to date.

### 3.6 Viewing Meter Log Files (cont.)

**Note:** The graph is displayed in its own window, which is opened on top of the Meter Log window. For instructions on using the Graph Log window, refer to the Graphing Output section in Chapter 2 of the PanaView User's Manual.

Remember that only two parameters per channel may be graphed, and that the same two parameters must be graphed for each channel of a multi-channel graph display. When you have finished viewing the graph, click on the **[Close]** option button to close the Graph window and leave the log running. To review log details, click on the **Contents** tab. The window now appears similar to Figure 21.

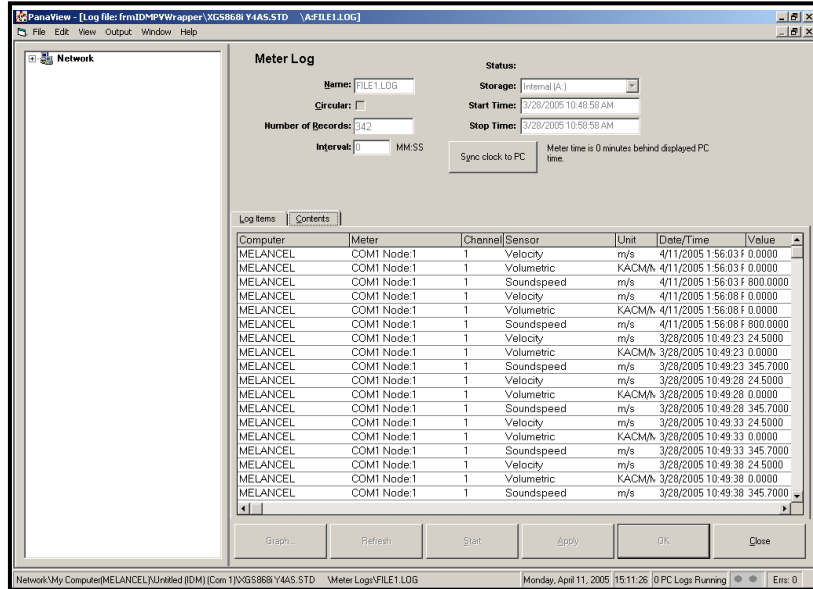

Figure 21: Typical Log Contents

### 3.7 Viewing PC Log Files

After one or more PC log files have been created, the logs may be viewed by using PanaView as follows:

1. You can access PC logs in two ways:
  - From the *New Meter Browser* in PanaView, expand the network tree and click on the *PC Logs* option. If you have created one or more logs, the tree will appear similar to Figure 22. Double-click on the log name to open the log, or
  - Pull down the *Output* menu (see Figure 13 on page 54), and click on the *Log Browser* option. Advance to the *PC Logs* dialog box as described in previous sections. A screen similar to that shown in Figure 23 appears.

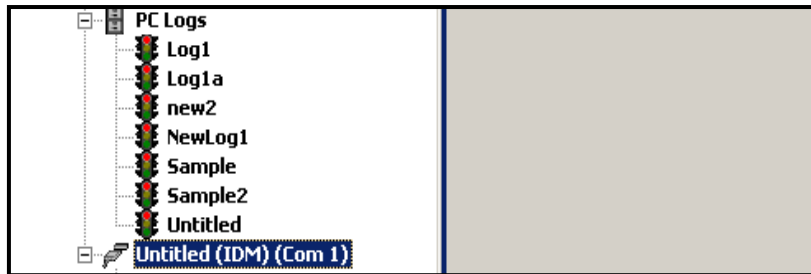

Figure 22: Expanded PC Logs Option

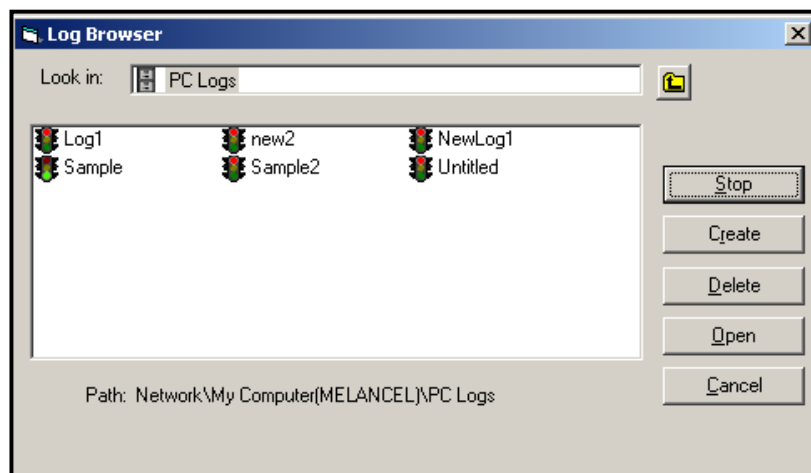

Figure 23: Selecting a Log File from the Log Browser

Notice that each of the log files in Figure 22 and Figure 23 has a traffic light icon next to its name. These icons indicate the current status of the log as follows:

- *red light* - log has not run to its specified stop time but has been manually stopped
- *green light* - log is currently running but is not yet complete

## 3.7 Viewing PC Logs (cont.)

2. In the *Log Browser*, after you highlight the name of the desired log file, the following option buttons become available:
  - **[Start]** – resumes logging if the log is currently stopped, or
  - **[Stop]** – stops logging, if the log is currently running
  - **[Delete]** – permanently deletes the log file
  - **[Open]** – opens the log in the *PC Log* window
3. Click on one of the option buttons listed in Step 2 above.

You can monitor the progress of an ongoing log in several ways:

- Click on the *Log Items* tab (see Figure 21 on page 58) for a list of the parameters specified for logging.
- Click on the *Contents* tab (see Figure 21 on page 58) for a list of all the data points logged to date for the parameter currently highlighted on the *Log Items* tab.
- Click on the **[Graph]** option button to display a graphical representation of the data logged to date.

**Note:** *The graph is displayed in its own window, which is opened on top of the PC Log window. For instructions on using the Graph Log window, refer to the Graphing Output section in Chapter 2 of the PanaView User's Manual.*

- Click on the **[Refresh]** option button to update the information shown on the *Contents* tab and in the *Graph Log* window. Any data logged since the last use of the **[Refresh]** option button is added to the list and to the graph.

Remember that only two parameters per channel may be graphed, and that the same two parameters must be graphed for each channel of a multi-channel graph display. When you have finished viewing the graph, click on the **[Close]** option button to close the *Graph* window and leave the log running.

4. To terminate the logging process, simply click on the **[Stop]** option button, which has replaced the original **[Start]** option button. (The *Stop Time* automatically appears in the *PC Log* window.)

Because a PC log has no specific “*Stop Time*,” the log will continue to run until it is manually stopped (unless the PC is turned off or you run out of hard drive space).

---

## Chapter 4. Printing Data

### 4.1 Data Types for Printing

The Model XGM868i flowmeter has no ability to print any of its data directly. However, any of the data stored in its memory may be printed via the built-in RS232 communications port, using a computer terminal. In order to use the capability, the XGM868i must be linked to the computer terminal with the optional *PanaView* software.

**Note:** See Chapter 1, Installation, of the Startup Guide for instructions on wiring the RS232 serial port. For additional information, refer to the EIA-RS Serial Communications Manual (916-054).

After making the hardware connections and installing *PanaView* software, the following data may be output to a printer connected to the personal computer:

- live data in numeric or graphical format
- log file in numeric or graphical format
- site file in tabular format
- transducer signal array data in tabular format

For detailed instructions on printing any of the data types listed above, consult the *PanaView User's Manual*.

[no content intended for this page]

---

## Chapter 5. Clearing Data

### 5.1 Introduction

This chapter explains how to purge totalized measurements, site data and/or log files from the XGM868i's memory.

**Note:** For detailed information on creating a log file, see Chapter 3, Logging Data. For detailed information on programming site data, see Chapter 1, Programming Site Data.

**IMPORTANT:** None of the clearing procedures described in this chapter can be undone. Be very sure that the exact consequences of a selected option are thoroughly understood before proceeding.

### 5.2 Clearing the XGM868i's Memory

If the XGM868i's available memory becomes nearly full, it may be necessary to purge some or all of the existing data from memory, before any additional data can be stored. In order to accomplish this task, proceed to the appropriate section for step-by-step instructions.

**Note:** Depending on the current configuration of the XGM868i, it may be possible to add additional memory by installing an option card in **Slot 2**. See Chapter 4, Parts Replacement, of the Service Manual for details.

#### 5.2.1 Clearing Site Data

This feature has not yet been implemented, because the XGM868i currently has no capability to store site files in its own memory.

## 5.2.2 Clearing Log Files

To clear log files from the XGM868i or from the PC's memory, complete the following steps:

1. From PanaView, click on the *Logging* option in the *Output* menu. Then click on the *Log Browser* option, as shown in Figure 24.

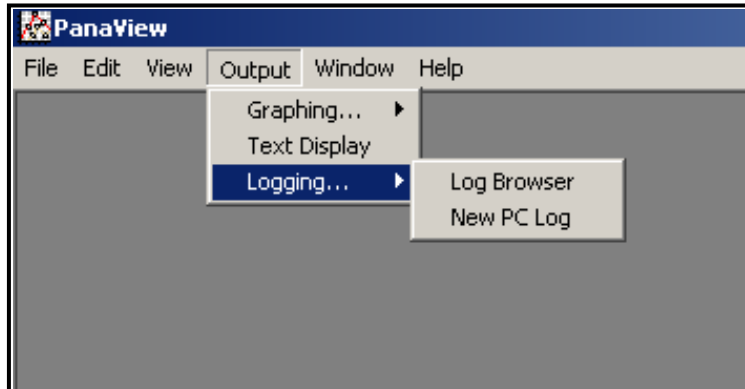

**Figure 24: Log Browser in the Logging Option**

2. Double-click on the *computer name* to move to the network level.
3. Double-click on *PC Logs* to access the stored PC logs, or on the *communication port name* and the *meter name* to access the stored meter logs. In either case, the *Log Browser* appears similar to Figure 25.

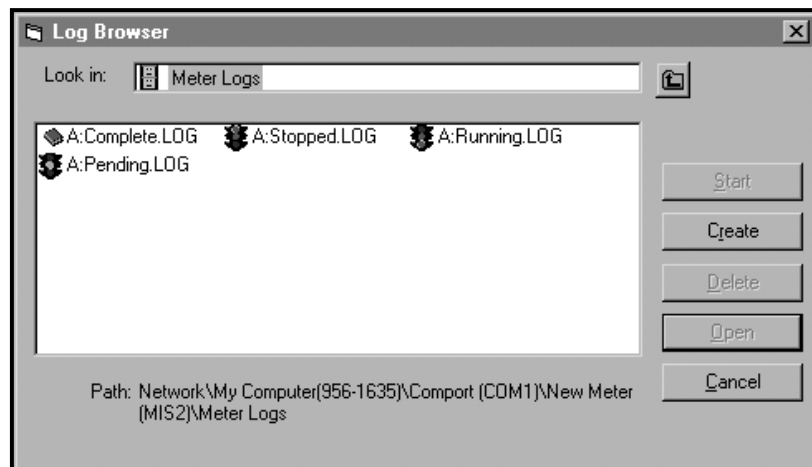

**Figure 25: Log Browser Window**

4. Highlight the log you wish to delete, and click on the [Delete] option button.



### 5.2.3 Clearing the Totalizers

You can clear the XGM868i's totalizers (i.e., reset specified totalized flow rates to zero) from either the LCD display or from PanaView. (Refer to Figures A-1, A-2, A-3 or A-4 in Appendix A.) To reset totals from the display, complete the following steps:

1. Press [Escape], [Enter], [Escape].
2. In the *Keypad Program*, scroll to RESET and press [Enter].
3. The XGM868i asks *Reset Totals?* Scroll to NO or YES (2) and press [Enter] at the desired choice.

The XGM868i totalizers are reset to 0, and the meter returns to the *Keypad Program*. Press [Escape] to return to the data display.

To reset the totals from PanaView:

1. From the *New Meter Browser* in PanaView, highlight the XGM868i.
2. Open the *Edit* menu and select the *Properties* option, as shown in Figure 26.

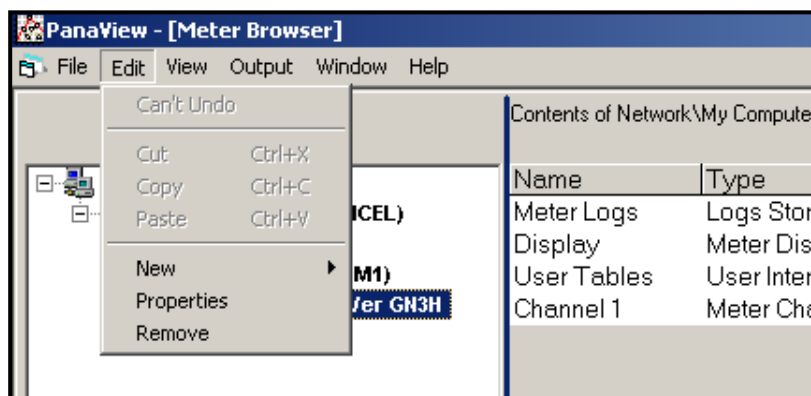

Figure 26: *Properties* Option in the *Edit* Menu

3. The *Properties* window appears similar to Figure 27. To clear the XGM868i totalizers, click on the [Clear Totalizers] button. The XGM868i totalizers are reset to 0.

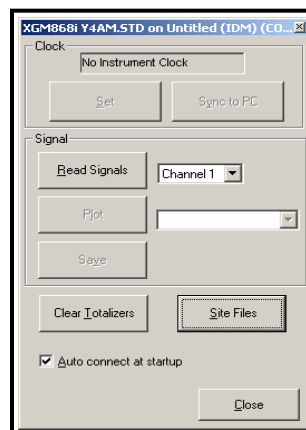

Figure 27: *Properties* Window

[no content intended for this page]

## Appendix A. Menu Maps



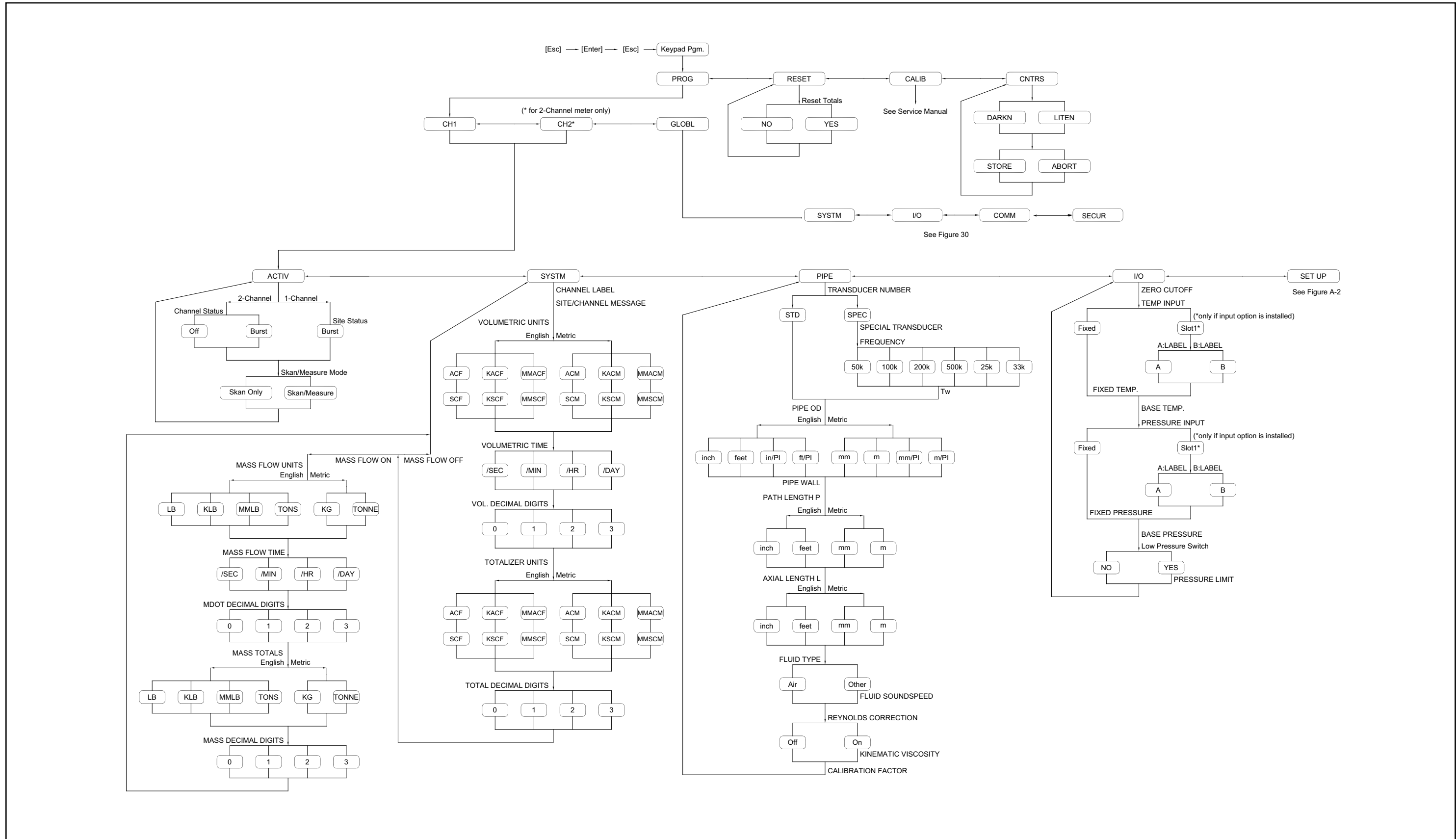

Figure 28: Channel - Status, System, Pipe Parameters & Input/Output Menu Map

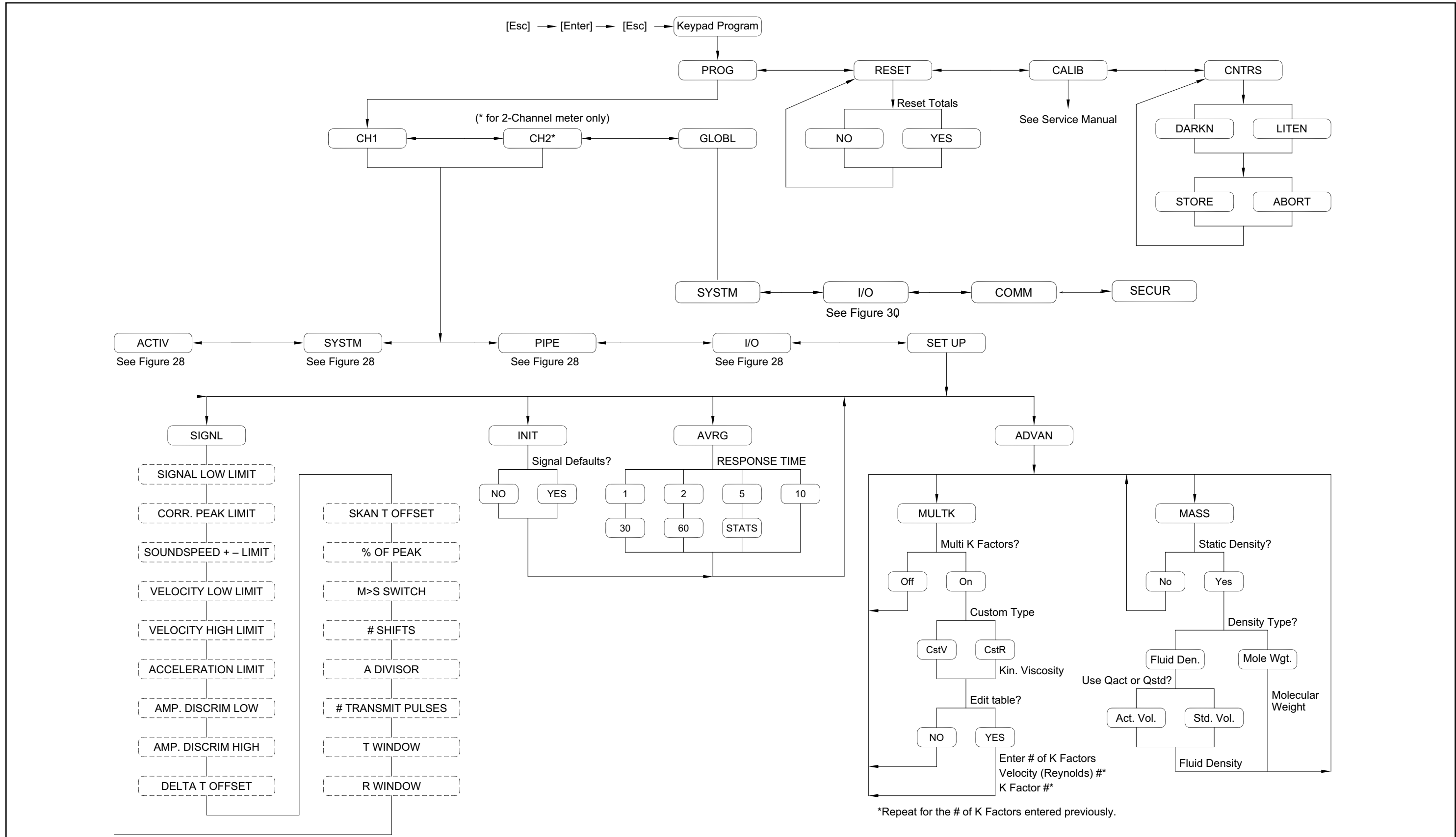

Figure 29: Channel - SETUP Menu Map

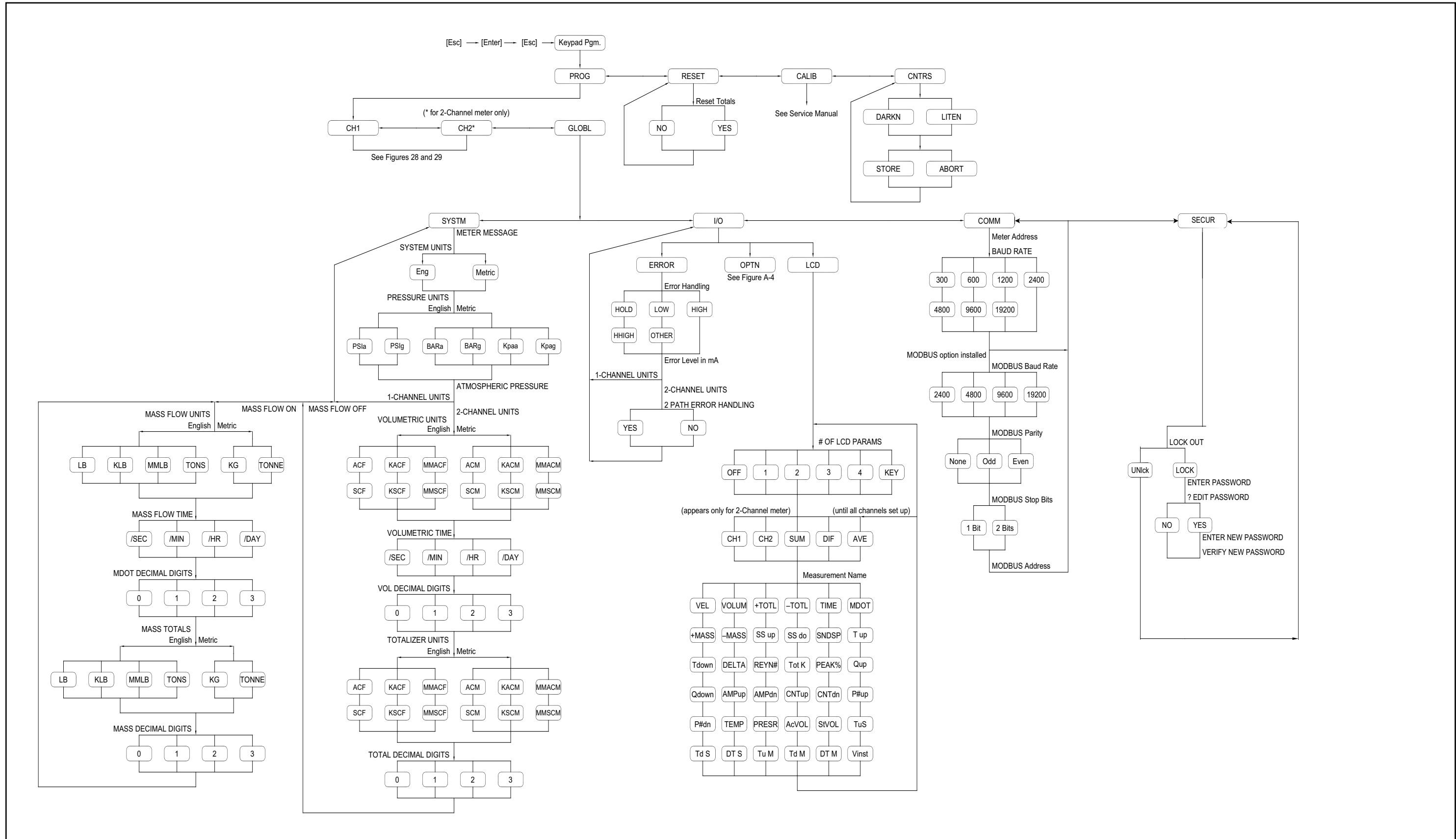

Figure 30: Global - System, Error Handling, LCD Display, & Comm Port Menu Map

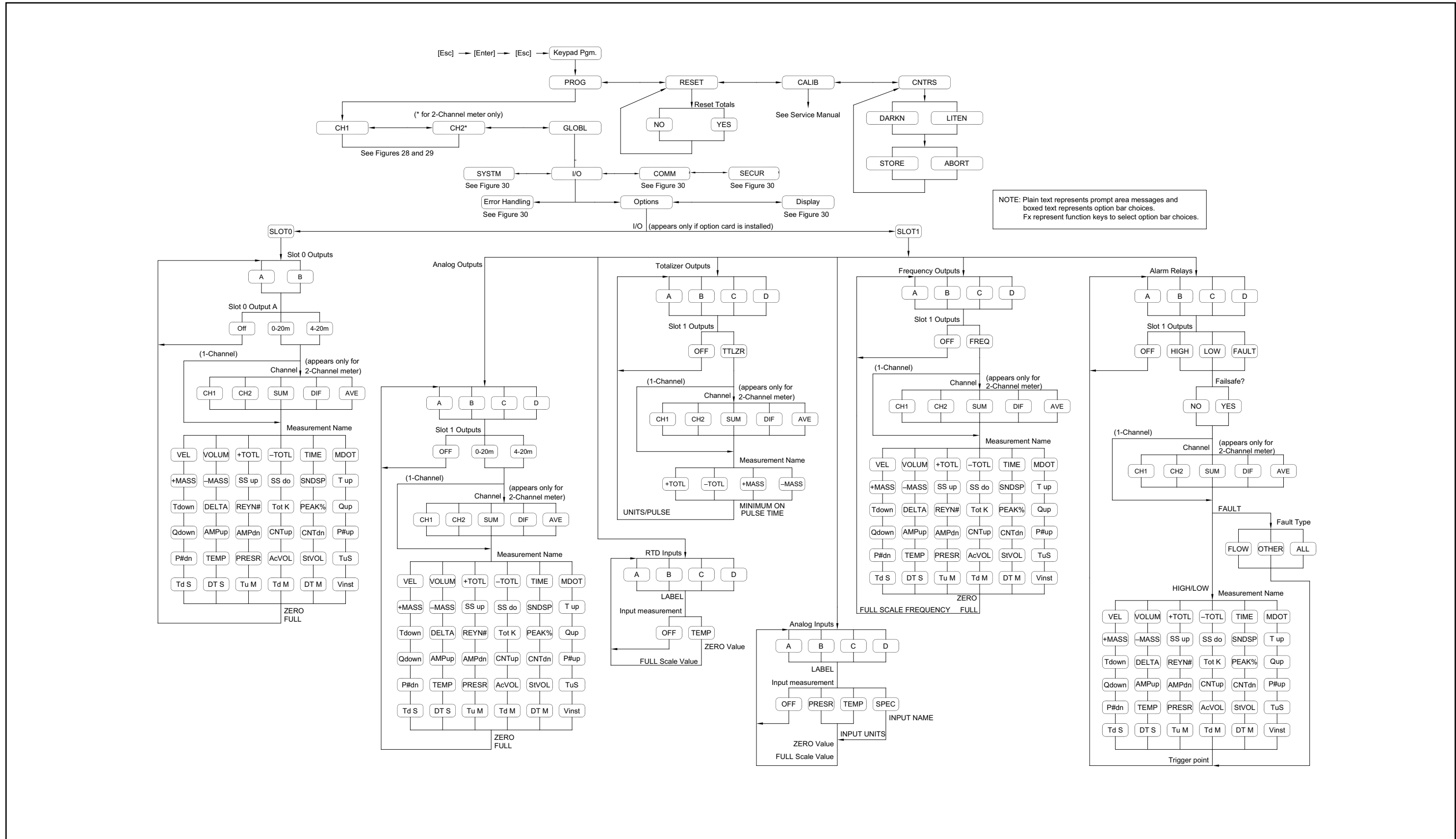

Figure 31: Global - Options Menu Map



## Appendix B. Data Records

### B.1 Available Option Cards

The Model XGM868i can hold one option card in Slot 1 and one in Slot 2. The available configurations are listed in Table 14.

**Table 14: Option Card Configurations**

Card #	Slot #	Configuration
1215-02	1	FF - 4 Frequency Outputs
1215-03		TT - 4 Totalizer Outputs
1215-04		FT - 2 Frequency Outputs/2 Totalizer Outputs
1215-05		FO - 2 Frequency Outputs
1215-06		TO - 2 Totalizer Outputs
1215-07		AA - 4 Standard Alarms
1215-09		FA - 2 Frequency Outputs/2 Standard Alarms
1215-11		TA - 2 Totalizer Outputs/2 Standard Alarms
1223-02/1473-02		OI - 2 Current Inputs
1223-03/1473-03		OR - 2 RTD Inputs
1223-04/1473-04		TI - 2 Current Inputs/2 Totalizer Outputs
1223-05/1473-05		TR - 2 RTD Inputs/2 Totalizer Outputs
1223-06/1473-06		FI - 2 Current Inputs/2 Frequency Outputs
1223-07/1473-07		FR - 2 RTD Inputs/2 Frequency Outputs
1223-08/1473-08		AI - 2 Current Inputs/2 Standard Alarms
1223-10/1473-10		AR - 2 RTD Inputs/2 Standard Alarms
1225-13		CO - 2 Current Outputs
1225-14		CF - 2 Current Outputs/2 Frequency Outputs
1225-15		CT - 2 Current Outputs/2 Totalizer Outputs
1225-16		CA - 2 Current Outputs/2 Standard Alarms
1430-03	2	RR - 4 RTD Inputs
1430-04		IR - 2 RTD Inputs/2 Current Inputs
1146-02/1332-02		128 KB Memory
1146-03/1332-03		2 MB Memory
1345-04		Modbus Communications Protocol
1385		HART Communication
1477-03		MODBUS/TCP/IP
1477-01		Ethernet
1475-01	2	Foundation Fieldbus

## B.2 Option Cards Installed

Whenever an option card is installed or changed in the Model XGM868i flow transmitter, record the type of card and any additional setup information in the appropriate row of Table 15.

**Table 15: Option Cards Installed**

Slot #	Type of Option Card	Additional Setup Information
0	Analog Outputs (A, B)	
1		
2		

### B.3 Setup Data

After the Model XGM868i flow transmitter has been installed, setup data must be entered via the *User Program* prior to operation. Record that information in Table 16.

**Table 16: Setup Data**

General Information					
Model #			Serial #		
Software Vers.			Setup Date		
Channel - Status					
Channel 1			Channel 2		
Channel Status	Off	Burst	Channel Status	Off	Burst
Measure Mode	Skam	S/M	Measure Mode	Skam	S/M
Channel - System					
Channel Label			Channel Label		
Site/Channel Msg.			Channel Message		
Vol. Units			Vol. Units		
Vol. Time Units			Vol. Time Units		
Vol. Dec. Digits			Vol. Dec. Digits		
Totalizer Units			Totalizer Units		
Tot. Dec. Digits			Tot. Dec. Digits		
Mass Flow			Mass Flow		
Mass Flow Time			Mass Flow Time		
MDOT Dec. Dig.			MDOT Dec. Dig.		
Mass Totalizer			Mass Totalizer		
Mass Dec. Dig.			Mass Dec. Dig.		
Channel - Pipe Parameters					
Channel 1			Channel 2		
Trans. Type	STD	SPEC	Trans. Type	STD	SPEC
Transducer #			Transducer #		
Spec. Trans. Freq.			Spec. Trans. Hz		
Spec. Trans. Tw			Spec. Trans. Tw		
Pipe O.D.			Pipe O.D.		
Pipe Wall			Pipe Wall		
Path Length (P)			Path Length (P)		
Axial Length (L)			Axial Length (L)		
Fluid Type	Air	Other	Fluid Type	Air	Other
Other/Sndspd			Other/Sndspd		
Calibration Factor			Calibration Factor		
Channel - Input/Output					
Zero Cutoff			Zero Cutoff		
Temp. Input			Temp. Input		

**Table 16: Setup Data**

Base Temp.				Base Temp.		
Pressure Input				Pressure Input		
Base Pressure				Base Pressure		
Low Press. Switch	No	Yes		Low Press. Switch	No	Yes
Pressure Limit				Pressure Limit		
<b>Channel - SETUP - V Averaging</b>						
Response Time				Response Time		
<b>Channel - SETUP - Advanced Features - Multi K Factors</b>						
K-Factor #	Velocity	K-Factor		K Factor #	Velocity	K-Factor
1				1		
2				2		
3				3		
4				4		
5				5		
6				6		
7				7		
8				8		
9				9		
10				10		
<b>Channel - SETUP - Advanced Features - Multi K Factors (cont.)</b>						
K-Factor #	Velocity	K-Factor		K Factor #	Velocity	K-Factor
11				11		
12				12		
13				13		
14				14		
15				15		
16				16		
17				17		
18				18		
19				19		
20				20		
<b>Channel - SETUP - Advanced Features - Mass Flow Calculation</b>						
Mass Flow	Yes	No		Mass Flow	Yes	No
Density Type	Fluid Dens.	Mole. Wgt.		Density Type	Fluid Dens.	Mole. Wgt.
Qact or Qstd?	Actual	Standard		Qact or Qstd?	Actual	Standard
Fluid Density				Fluid Density		
Mole. Weight				Mole. Weight		
<b>Global - System</b>						
Meter Message				Totalizer Units		
System Units	English	Metric		Tot. Dec. Digits		
Pressure Units				Mass Flow		
Atmos. Pressure				Mass Flow Time		

**Table 16: Setup Data**

Vol. Units			MDOT Dec. Digit	
Vol. Time Units			Mass Totals	
Vol. Dec. Digits			Mass Dec. Digits	
Global - Input/Output - Error Handling				
Error Handling			2-Path Error	No      Yes
Global - Communications Port				
Meter Address			MOD. Parity	
Baud Rate			MOD. Stop Bits	
MOD. Baud Rate			MOD. Address	

[no content intended for this page]

## Appendix C. Programming the XGM868i Using PanaView™

### C.1 Introduction

The Model XGM868i flow transmitter must be properly installed and programmed, as described in the *Startup Guide*, before it can provide accurate flow rate measurements. After completing the installation and initial setup, use this chapter to program the advanced features of the Model XGM868i's via the PanaView™ software program. Refer to the appropriate section for a discussion of the following menu features:

- Channel-Status - activate one or both channels and select the desired measurement method
- Channel-System - enter the individual channel parameters
- Channel-Pipe - enter the pipe parameters
- Channel-I/O - set up the inputs and outputs
- Channel-Setup - set the signal limits, response times and activating mass flow.
- Global-System - enter the system units
- Global-I/O - set up error handling, option cards and display
- Global-Comm - set the serial port and MODBUS parameters

As a programming aid, a complete set of menu maps for the PROG menu is included in Appendix D, *PanaView Menu Maps*. The specific figure numbers will be referenced throughout this chapter, as required.

### C.2 Programming Using PanaView™

You can program the XGM868i through PanaView™, a PC-based, non-resident software program that communicates with the XGM868i via its RS232 serial port.

#### C.2.1 Preparing for PanaView Programming

Before you attempt to communicate with the XGM868i, be sure you have linked your PC to the XGM868i via an RS232 interface. For details on wiring the interface, refer to *Wiring the Serial Port* in the *Startup Guide*, and to the document *EIA-RS Serial Communications* (916-054). You must also install PanaView, as discussed in the *PanaView User's Manual* (910-211).

## C.2.2 Setting Up the Communications Port

Use the steps below to establish PanaView communications with the XGM868i.

1. Launch PanaView, as discussed in Chapter 3, *Initial Setup*, of the *PanaView User's Manual*.
2. Open the *New Meter Browser* window in the *File* menu and expand the network tree. Then, highlight the *My Computer (Name)* branch by clicking on it.
3. Pull down the *Edit* menu by clicking on it in the menu bar.
4. Click on the *New* menu option to select it, and a submenu opens with two choices on it (see Figure 32).

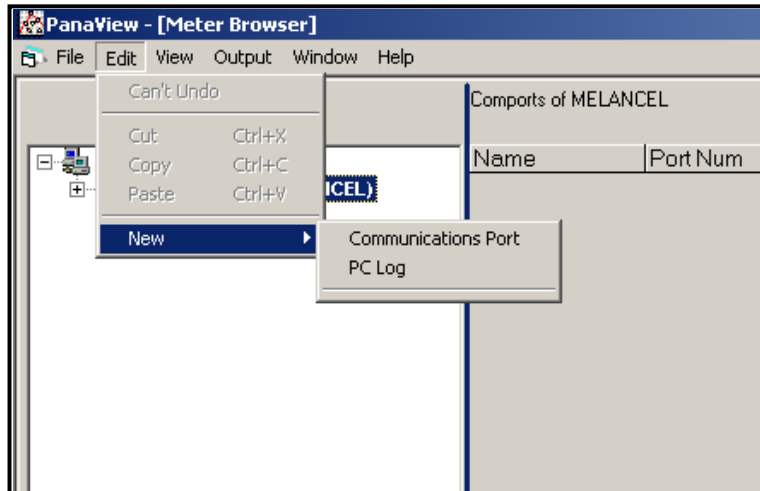
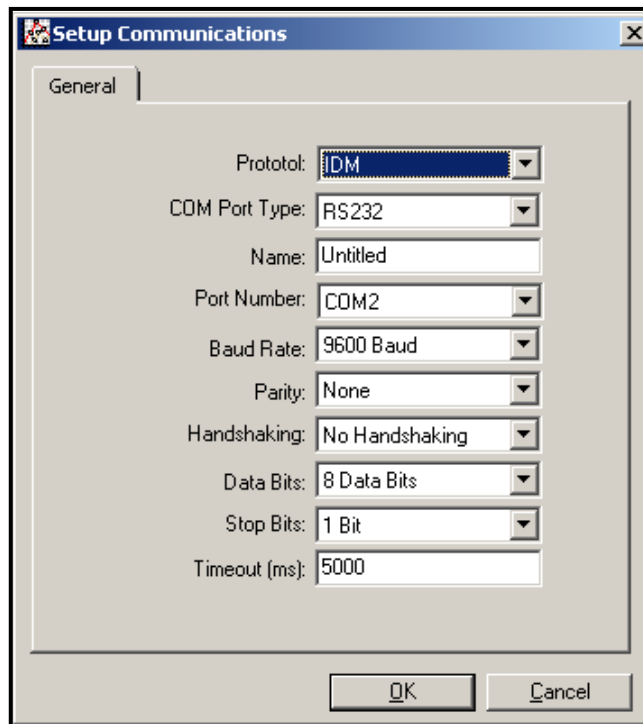

Figure 32: Edit Menu



## C.2.2 Setting Up the Communications Port (cont.)

- Click on the *Communications Port* option to select it. The *Setup Communications* screen appears similar to Figure 33.



**Figure 33: Setup Communications Screen**

- Open the Protocol menu (the first of the drop-down menus) and click on *IDM*.
- Open the COM Port Type menu and click on the desired type (or on *TCP/IP*, if the XGM868i is using an Ethernet connection).

**Note:** If you select *TCP/IP*, the menu changes. Proceed to the next page.

- Select any suitable available baud rate. A baud rate of 19,200 is appropriate for almost all applications. However, if you experience periodic communication reliability problems, you may wish to consider lowering the baud rate on your instrument and in PanaView.

**IMPORTANT:** Be sure all the communications port settings match those made in setting up the meter's serial port.

- Click on [OK] to complete data entry.

## C.2.3 Setting up Ethernet Communications

If you have selected TCP/IP in step 6 on the previous page, the Setup Communications window appears similar to Figure 34.

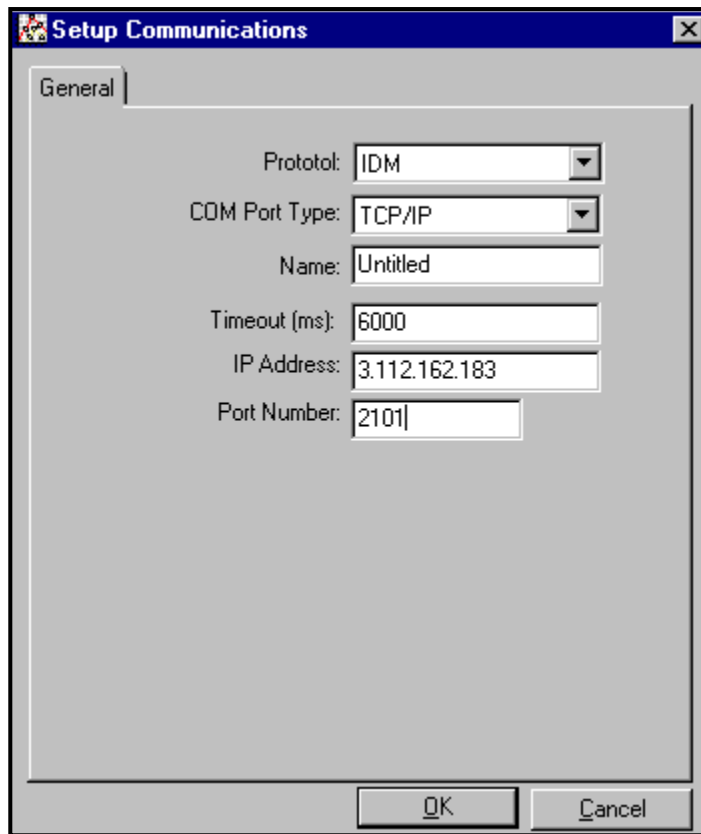

**Figure 34: Setup Communications for TCP/IP**

1. Type in the desired *Name* and *Timeout* (in milliseconds).
2. In the *IP Address* text box, enter the IP address. If the IP address is unknown, run the Device Discovery software utility. All units found will be identified by their MAC address and the assigned IP address. In the *Port Number* box, enter 2101 (the default value).
3. Click [OK] to complete data entry.

**IMPORTANT:** *If you are using Ethernet communications, be sure the XGM868i is set up with the default communications parameters: 9600 baud, no parity, no handshaking, 8 data bits and 1 stop bit. The port number must match the "Enable Raw TCP access using TCP Port" assignment shown under the Device Discovery "TCP Server Settings" menu (Configuration>Serial Ports>Port).*

## C.2.4 Modifying Ethernet Parameters

To establish Ethernet communications with the XGM868i or to modify its IP parameters, you will need to install the Ethernet Device Discovery software utility (available with your XGM868i) on a PC connected to the LAN. Once installed and running, the software displays all Ethernet devices currently connected to the subnet. You can identify the XGM868i by its MAC address, supplied as part of customer documentation. The default IP Port is 2101.

The default IP addressing for the XGM868i is DHCP (dynamic). If you need to assign a static IP address to the XGM868i, complete the following steps:

**IMPORTANT:** *To assign a static IP address, the XGM868i must be connected to an Ethernet network with a dynamic address assignment mechanism (DHCP) first.*

1. Run Ethernet Device Discovery software, and identify the XGM868i's current IP address.
2. Open your Internet browser (Internet Explorer, Netscape, or other) and type the XGM868i IP address in the Address box.
3. The Connect ME Configuration and Management window opens. Two text boxes ask for the user name and password.
  - a. In the Username text box, type root.
  - b. In the Password text box, type dbps.
4. At the left of the window, click on Network.
5. The IP Settings window opens. In the text boxes for IP Address, Subnet Mask, and Default Gateway, type in the new information.
  4. Click Apply. The software applies the new address.

### C.3 Adding the XGM868i

To add the XGM868i on the IDM-configured communications port, complete the following steps:

1. Highlight the communication port to which the meter will be added by clicking on it, and then open the *Edit* menu on the menu bar (if the communication port is not highlighted first, the *New Meter* option is not active in the *Edit* menu).
2. Click on the *New* option in the *Edit* menu (see Figure 35).

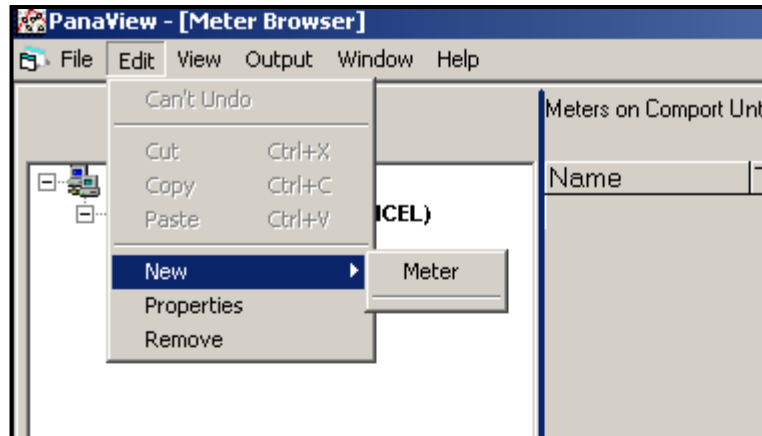

Figure 35: *New* Option in the *Edit* Menu

3. After clicking on the *New* option, the *Meter* menu option appears. Click on this option to select it.
4. The *New IDM Meter* screen (shown in Figure 36) opens. Enter the Network ID number for the meter, and click [OK].

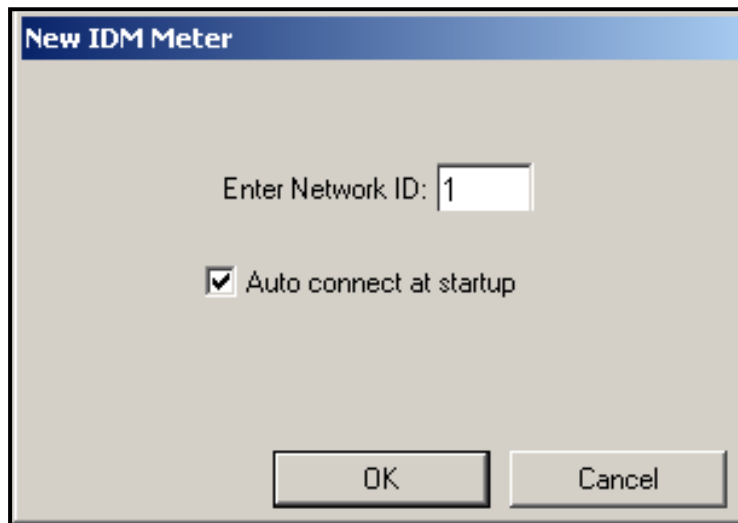

Figure 36: *New IDM Meter* Screen

### C.3 Adding the XGM868i (cont.)

**IMPORTANT:** The Network ID number must match the Network ID programmed in the meter's Communications menu.

If the initialization is successful, the Meter Browser shows a listing similar to Figure 37.

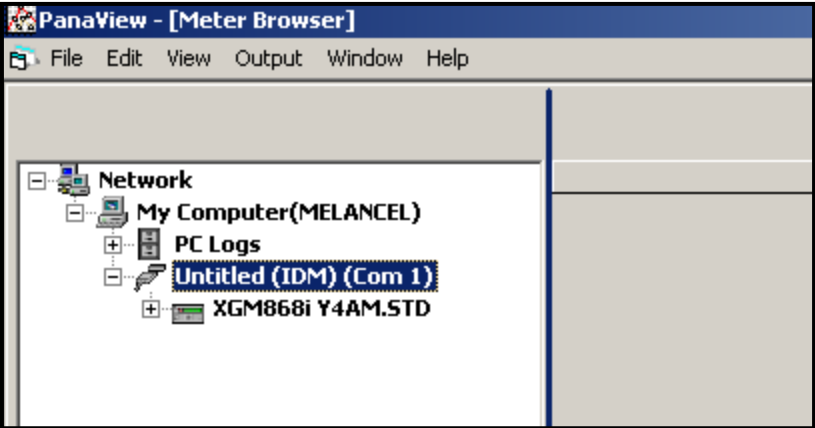

Figure 37: Updated Network Tree

However, if the settings do not match, or there is some other difficulty, a screen appears similar to Figure 38.

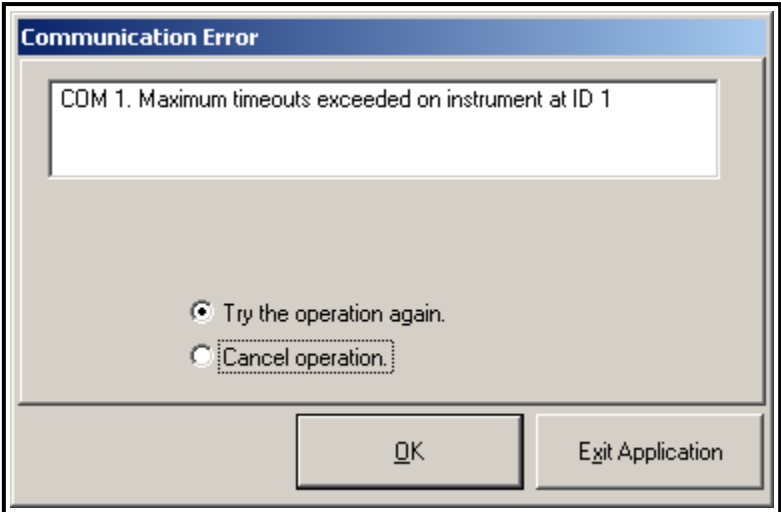

Figure 38: Communication Error Screen

The screen offers the options of trying again or of canceling the operation. Click on the desired choice, and then on [OK] to confirm the choice or on [Exit Application] to close PanaView.

## C.4 Entering the User Program Using PanaView

**Note:** Be sure to record all the programming data entered in this chapter in Appendix B, Data Records.

Programming of the Status, System, and Pipe submenus of the Channel menu and the Global-System menu are required for basic operation of the Model XGM868i. Failure to accurately enter all of the necessary information will result in unreliable flow rate data. Therefore, be sure to complete at least the sections of this chapter pertaining to those three submenus. Except for those three submenus, it is not necessary to program the Model XGM868i flowmeter in any particular order. Therefore, the sections of this chapter need not be completed in sequence. Enter the user program as described below and proceed immediately to any section of interest.

To begin entering data into the XGM868i via PanaView:

1. From the meter tree in the *New Meter Browser* (see Figure 37 on page 85), click on the XGM entry. The screen now appears similar to Figure 39.

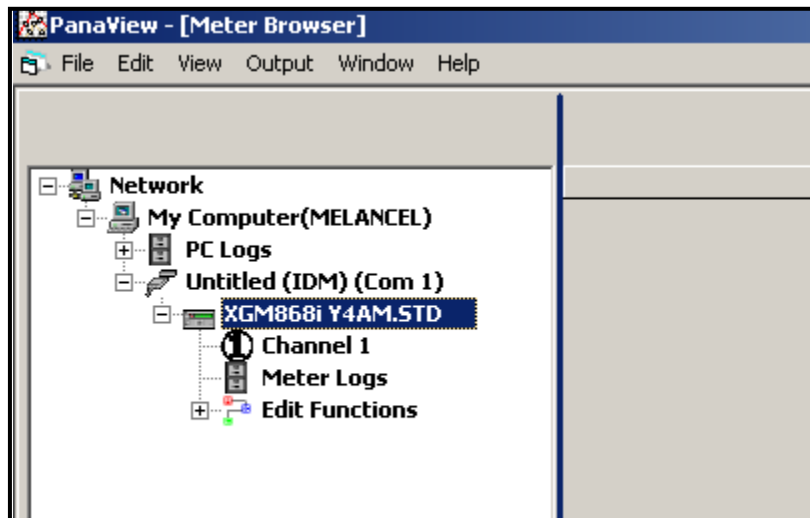

**Figure 39: Meter Tree with *Edit Functions* Option**

2. Expand the *Edit Functions* option. The window now appears similar to that shown in Figure 40 on page 87.

### C.4 Entering the User Program Using PanaView (cont.)

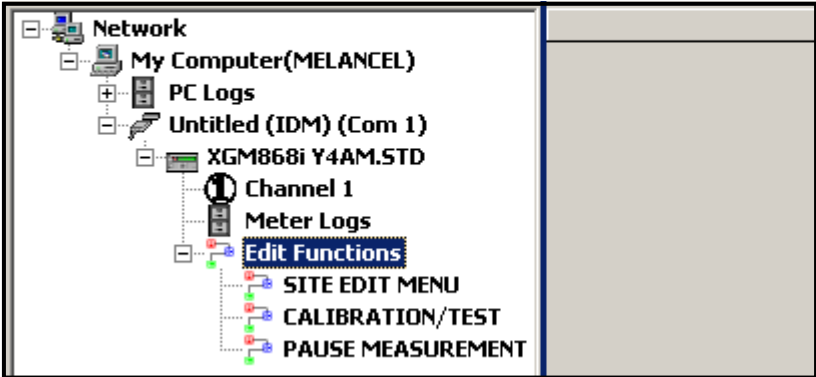

Figure 40: Menus in the *Edit Functions* Option

3. To enter data into the user program, double-click on the *Site Edit Menu*. The window appears similar to Figure 41.  
**Note:** For a 1-Channel XGM868i, the Channel 2 option does not appear.

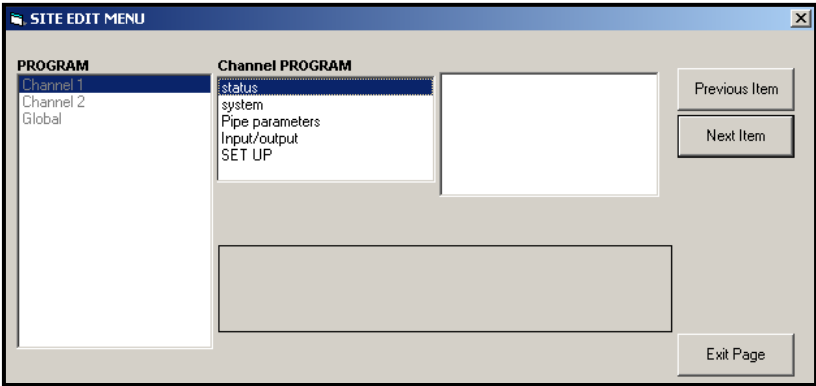
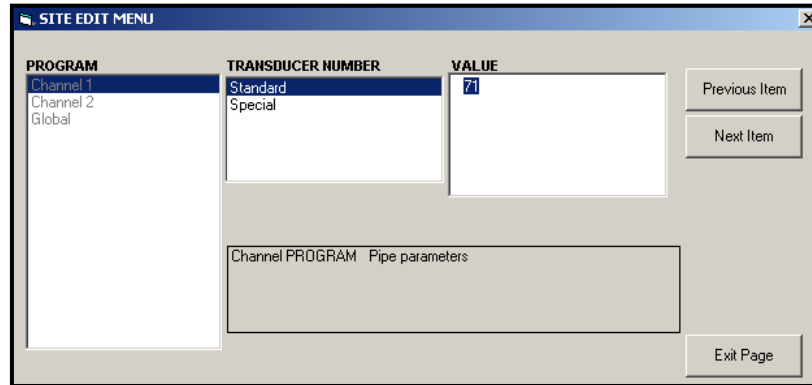

Figure 41: *Site Edit Menu* Window

- 4. To enter a particular menu (Channel 1, Channel 2, or Global), highlight and double-click on the desired menu in the left pane. For example, clicking on Channel 1 in Figure 41 opens the list of options shown in the center pane.
- 5. To enter a particular option:
  - a. Highlight and double-click on the desired option in the center pane. Figure 42 on page 88 shows the first entry (Transducer Number) in the *Pipe Parameters* option. The title above the center pane lists the current entry, while the center pane displays the available selections for that entry.
  - b. Click on the desired choice; if the entry requires a numeric or text value, change the value displayed in the right pane.

## C.4 Entering the User Program Using PanaView (cont.)



**Figure 42: Pipe Parameters Option in the *Site Edit Menu***

- c. Do one of the following:

Click on [Next Item] to proceed to the next menu item, or

Click on [Previous Item] to return back through the menu to a previous item.

**Note:** *If you click on either [Next Item] or [Previous Item] without changing the settings, the current settings remain unchanged.*

As you step through the menu, the bottom panel lists the current settings you have modified or left unchanged, as shown in Figure 43. If you modify or step through more than five items, a scroll bar at the right of the panel lets you review the earlier settings.

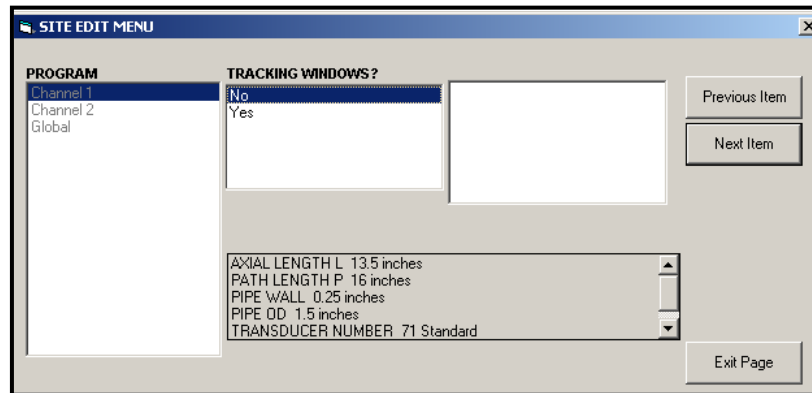

**Figure 43: *Site Edit Menu* with Current Settings**

6. When you have completed entering parameters in a given option, click [Exit Page] to close the option. You can then double-click on another option, or click [Close] to close the window.

You can double-click on another menu to modify its settings, or return to the *New Meter Browser*. Proceed to the following sections to enter data in the Channel or Global menus.



## C.5 Entering Data in the Channel Menu

The Channel menu is used to enter data specific to each channel. Refer to Figures D-1 through D-3 in Appendix D, *PanaView Menu Maps*, and remember to record all programming data in Appendix B, *Data Records*.

**Note:** *In this manual, only the programming of Channel 1 will be described. To program Channel 2 of a 2-Channel meter, simply repeat the same procedures presented for Channel 1.*

### C.5.1 Selecting the Channel Measurement Method

The Status submenu permits selection of the desired measurement method.

1. In the *Site Data Menu*, double-click on the desired channel.
2. Highlight and double-click on the Status option in the center pane. The window now appears similar to Figure 44.

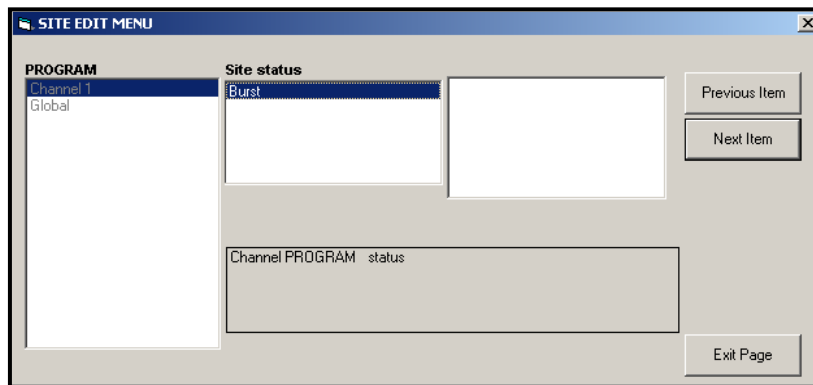

**Figure 44: Status Option in the Channel Menu**

3. Double-click on *Burst* to activate the channel/path.

**Note:** *Burst is automatically selected for a 1-Channel meter.*

4. Double-click on one of the measurement methods described below.
  - Skan Only is the preferred technique for locating the acoustic signal and for high velocity measurements. It is more robust in a noisy environment than the Measure technique.
  - Skan/Measure is the preferred technique to use for low velocity measurements.

If Skan Only is selected at the above prompt, the meter uses this technique exclusively. However, if Skan/Measure is selected, the meter uses Skan Only to find the acoustic signal and then tries to use the Skan/Measure technique for the actual measurement.

**Note:** *To change the Skan Only and Skan/Measure parameters, see the Signal submenu section on page 11.*

PanaView returns to the Channel PROGRAM menu (see Figure 41 on page 87). Proceed to the System option.

## C.5.2 Entering Data in the Channel System Option

1. From the Channel PROGRAM menu, highlight and double-click on the System option in the center pane.
2. The first prompt asks for the *Channel Label*. Enter the desired label (in any numeric or text combination up to five characters) in the right pane, and click [Next Item].
3. Enter the desired *Channel Message*, and click [Next Item].
4. Double-click on the desired *Volumetric Units* (from the list shown in Table 17).

**Note:** Refer to the System option of the Global menu to choose between English or metric measurements.

**Table 17: Available Volumetric/Totalizer Units**

English	Metric
Actual Cubic Feet	Actual Cubic Meters
Thousands of ACF	Thousands of ACM
Millions of ACF	Millions of ACM
Standard Cubic Feet	Standard Cubic Meters
Thousands of SCF	Thousands of SCM
Millions of SCF	Millions of SCM

5. Double-click on the desired unit of *Volumetric Time* (from seconds to days) in the volumetric flow display.
6. Double-click on the desired number of *Decimal Digits* (digits to the right of the decimal point) in the volumetric flow display.
7. Double-click on the desired *Totalizer Units* for the totalized flow rate display (listed in Table 17).
8. Double-click on the desired number of *Decimal Digits* (digits to the right of the decimal point) in the totalized flow rate display.

The program now varies, depending on whether you have activated MASS FLOW (see Chapter 1 for details).

- If you have activated MASS FLOW, continue to step 1 on the next page.
- If you are not using MASS FLOW, PanaView returns to the Channel PROGRAM window shown in Figure 41 on page 87. Proceed to the Pipe option.

**C.5.2a Programming the Mass Flow Option**

1. Double-click on the desired *Mass Flow* units for flow rate display (listed in Table 18).

**Table 18: Available Mass Flow Units**

English	Metric
Pounds	Kilograms
KiloPounds = Thousands of Pounds	Tonnes = Metric Tons (1000 KG)
MillionPounds	
TONS (2000 LB)	

- 2. Double-click on the desired *Mass Flow Time* units.
- 3. Double-click on the desired number of *MDOT Decimal Digits* (digits to the right of the decimal point) in the mass flow rate display.
- 4. Double-click on the desired *Mass Totalizer* units for the totalized mass flow rate display (listed in Table 18).
- 5. Double-click on the desired number of *Mass Decimal Digits* (digits to the right of the decimal point) in the totalized mass flow rate display.

PanaView returns to the Channel PROGRAM window shown in Figure 41 on page 87. Proceed to the Pipe option on the next page.

### C.5.3 Entering Pipe Parameters

Enter the transducer and pipe parameters via the Pipe submenu. While following the programming instructions, see Figure 55 on page 129 of Appendix D, *PanaView Menu Maps*.

1. From the Channel PROGRAM menu, highlight and double-click on the Pipe Parameters option in the center pane.
2. The first prompt asks for the *Transducer Number*.
  - For a standard transducer, double-click on the *Standard* option in the center pane. Then enter the number engraved on the transducer head in the right pane, and click [Next Item].
  - If there is no number engraved on the transducer head, double-click on the *Special* option, enter an assigned number (from 91 to 99), and click [Next Item].

**IMPORTANT:** *Special transducers, which have no engraved number on the head, are rarely used. Examine the transducer head carefully for a number.*

The menu now varies, depending on your selection in step 2.

- If you entered the number for a standard transducer, proceed to the *Pipe OD* prompt in step 4.
- If you entered the number for a special transducer, proceed to step 3 below.

#### C.5.3a Special Transducers

3. For special transducers:

**Note:** *Panametrics will supply the information required for steps a and b with the transducers.*

- a. Double-click on the appropriate *Frequency* (from 25 kHz to 500 kHz). The frequency is required to transmit an excitation voltage at the transducer's natural frequency.
- b. Enter the *Time Delay (Tw)* value supplied by Panametrics and click [Next Item].

$T_w$  is the time required for the transducer signal to travel through the transducer and its cable. This time delay must be subtracted from the transit times of the upstream and downstream transducers to ensure an accurate measurement.

### C.5.3b Pipe OD

4. Click on the appropriate *Pipe OD Unit* type in the center pane from the list shown in Table 19. Then enter the known pipe outside diameter or circumference in the right pane and click [Next Item]. Obtain the required information by measuring either the pipe outside diameter (OD) or circumference at the transducer installation site. The data may also be obtained from standard pipe size tables found in *Sound Speeds and Pipe Size Data* (914-004).

**Table 19: Available Pipe OD Units**

English	Metric
inch	mm
feet	meters
circum.in = pipe circumference in inches	circum.mm = pipe circumference in millimeters
circum.ft = pipe circumference in feet	circum.m = pipe circumference in meters

5. Enter the known *Pipe Wall Thickness* (in inches or mm) in the right pane and click [Next Item].

### C.5.3c Path and Axial Lengths

6. Click on the appropriate *Path Length* unit type in the center pane. Then enter the path length of the ultrasonic signal in the right pane and click [Next Item].

**Note:** *If a spoolpiece was ordered with the meter, the transducer signal path length (P) and the transducer signal axial length (L) are engraved on the flowcell and/or are included in the documentation supplied with the meter. For on-site transducer installations, refer to Appendix C, Measuring P and L Dimensions, in the Startup Guide for instructions.*

7. Click on the appropriate *Axial Length* unit type in the center pane. Then enter the axial length of the ultrasonic signal in the right pane and click [Next Item].

### C.5.3d Fluid Type

8. Double-click on the appropriate *Fluid Type*, either *Air* or *Other*.
- If you select *Other*, PanaView asks for the *Fluid Soundspeed*. Enter the appropriate soundspeed (in ft/sec) and click [Next Item].

### C.5.3e Reynolds Correction

9. Double-click on the appropriate choice to indicate whether you want *Reynolds Correction*.
- If *Off* is selected, enter the *Calibration Factor* and click on [Next Item].
  - If *On* is selected, enter the *Kinematic Viscosity* and click [Next Item]. Then enter the *Calibration Factor* and click [Next Item].

PanaView returns to the Channel PROGRAM menu. You have completed entering pipe parameters.

## C.5.4 Entering Input/Output Parameters

Enter the zero cutoff value and set up the temperature, pressure and quality inputs via the Input/Output submenu. While programming these parameters, refer to Figure 55 on page 129 of Appendix D, *PanaView Menu Maps*.

**IMPORTANT:** *If an option card in Slot 1 fails to appear in this menu, it may be turned OFF. See the Global-I/O-Options section on page 105 for setup instructions.*

### C.5.4a Zero Cutoff Value

Near a zero flow rate, the Model XGM868i's readings may fluctuate due to small offsets caused by thermal drift or similar factors. To force a zero display reading when there is minimal flow, enter a *zero cutoff value* as described in the following steps:

1. From the Channel menu, highlight and double-click on the Input/Output option in the center pane.
2. The program asks for the *Zero Cutoff*. Enter a value from 0 to 1 ft/sec (0 to 0.30 m/sec) for the zero cutoff and click [Next Item]. The recommended setting is 0.1 ft/sec (0.03 m/sec).

### C.5.4b Temperature Input

The XGM868i can use either a fixed temperature value or a live temperature input to calculate the density for the mass flow rate display.

1. Double-click on a *Fixed* temperature value or to set up the option card in *Slot 1* that will supply the live temperature input and press [Next Item].

**Note:** *If Slot 1 contains an activated option card with an analog input assigned to Temperature or an RTD input, Slot 1 appears as an option at the above prompt. If the process temperature is stable, a fixed value may be used, but most applications require a live temperature input. If there is no active option card for temperature, the meter assumes you are using a fixed temperature.*

2. Proceed to one of the following sections:
  - If you selected *Fixed* - proceed to Step 3.
  - If you selected *Slot 1* - proceed to Step 4.
3. Enter the known *Fixed Temp.* (process temperature) and click [Next Item]. The meter will accept values from -328 to 1,832°F (-200 to 1,000°C). Proceed to *Base Temperature* on the next page.
4. Select *Input A* or *Input B* and click [Next Item]. The inputs were labeled during setup.

**Note:** *The set up of Input A is used as an example. Identical procedures would be used to set up Input B.*

## C.5.4 Entering Input/Output Parameters (cont.)

### C.5.4c Base Temperature

1. Enter the *Base Temperature* and click [Next Item]. The ratio of this value to the actual temperature is used to calculate the standard mass flow rate.
2. Do one of the following:
  - If you selected Pressure as the Input Type, proceed to *Pressure Input* below.
  - If you selected Temperature as the Input Type, proceed to *Base Pressure* below.

### C.5.4d Pressure Input

1. Double-click on a *Fixed* pressure value or to set up the option card in *Slot 1* that will supply the live pressure input.
 

**Note:** *If Slot 1 contains an activated option card with an input assigned to Pressure, Slot 1 appears as an option at the above prompt. If the process pressure is stable, a fixed value may be used, but most applications require a live pressure input. If there is no active option card for pressure, the meter assumes you are using a fixed pressure.*
2. Proceed to one of the following steps:
  - If you selected Fixed – proceed to Step 3.
  - If you selected Slot 1 – proceed to Step 4.
3. Enter the known *Fixed* process *Pressure* and click [Next Item]. The meter will only accept values from 0 to 5,000 psia. Proceed to *Base Pressure* below.
5. Double-click on *Input A* or *Input B*. The inputs were labeled during setup.

**Note:** *The set up of Input A is used as an example. Identical procedures would be used to set up Input B.*

### C.5.4e Base Pressure

1. Enter the *Base Pressure* and click [Next Item]. The ratio of this value to the actual pressure is used to calculate the standard mass flow rate.

### C.5.4f Low Pressure Switch

1. Click on *Yes* or *No* to activate or deactivate the *Low Pressure Switch* software function and click [Next Item].
  - If you selected *Yes*, enter the *Pressure Limit*, the low pressure switch set point, and click [Next Item]. The acceptable range is 0 to 5,000 psia. The meter will stop taking readings if the pressure drops below this value.

PanaView returns to the Channel PROGRAM menu. You have completed entering input/output parameters.

## C.5.5 Entering Setup Parameters

The signal limits and response times for the Model XGM868i are specified via the SETUP submenu. While following the programming instructions, refer to Figure 57 on page 131 of Appendix D, *PanaView Menu Maps*. This submenu includes four options:

- Signal - set the parameters related to the transducer signal
- V Averaging - specify the response of the meter to step changes
- Default Setup - initialize all parameters to default values
- *Advanced Features* - enable mass flow or activate K factors.

To enter the Set Up submenu, highlight and double-click on the *Set Up* option in the center pane of the Channel menu. Remember to record all programmed data in Appendix B, *Data Records*.

### C.5.5a The Signal Option

Use this option to set the limits for the incoming signal and other parameters affecting the transducer signal. For example, the programmed signal strength low limit may be used to determine the trigger point for an alarm.

**CAUTION!**     **The Signal default settings are suitable for most applications. Consult the factory before changing any of these parameters.**

1. From the Set Up option menu, highlight and double-click on *Signal* in the center pane.
2. For each parameter, click [Next Item] to accept the current value or enter a new value and click [Next Item]. Table 20 on page 97 lists ranges and default parameters for each parameter.



Table 20: Transducer Signal Settings

Transducer Signal Parameters	Range	Default Value	Description
Signal Low Limit	-20 to 100	20	The E1:LOW SIGNAL error message appears when the signal strength falls below the programmed SIGNAL LOW LIMIT value. See Chapter 2 in the <b>Service Manual</b> for a discussion of error codes.
Correlation Peak Limit	0 to 500	100	The E4: SIGNAL QUALITY error message appears when the signal quality falls below the programmed COR. PEAK LIMIT value. See Chapter 2 in the <b>Service Manual</b> for a discussion of error codes
Soundspeed+ - Limit	1 to 50%	20%	The E2:SOUNDSPEED error message appears when the calculated fluid sound speed differs from the fluid sound speed entered in the Channelx-System menu by more than the programmed SOUNDSPEED +- LIMIT value. See Chapter 2 in the <b>Service Manual</b> for a discussion of error codes.
Velocity Low Limit	-500 to 500 ft/sec (-150 to 150 m/sec)	-150 ft/sec (-46 m/sec)	The E3: VELOCITY RANGE error messages appears when the calculated fluid velocity is less than the programmed VELOCITY LOW LIMIT value. See Chapter 2 in the <b>Service Manual</b> for a discussion of error codes.
Velocity High Limit	-500 to 500 ft/sec (-150 to 150 m/sec)	150 ft/sec (46 m/sec)	The E3: VELOCITY RANGE error messages appears when the calculated fluid velocity exceeds the programmed VELOCITY HIGH LIMIT value. See Chapter 2 in the <b>Service Manual</b> for a discussion of error codes.
Acceleration Limit	0 to 250 ft/s (0 to 76 m/s)	15 ft/s (5 m/s)	The E6: CYCLE SKIP error message appears when the calculated fluid velocity changes by more than the programmed ACCELERATION LIMIT value from one reading to the next. See Chapter 2 in the <b>Service Manual</b> for a discussion of error codes.
Amplitude Discriminator Low	0 to 100	14	The amplitude discriminator measures the transducer signal received by the Model XGM868i. The default value for the above parameter is 14, and values from 0 to 100 are acceptable. The E5: AMPLITUDE error message appears when the amplitude discriminator falls below the programmed AMP. DISCRIM LOW value. See Chapter 2 in the <b>Service Manual</b> for a discussion of error codes.
Amplitude Discriminator High	0 to 100	34	The amplitude discriminator measures the transducer signal received by the Model XGM868i. The default value for the above parameter is 34, and values from 0 to 100 are acceptable. The E5: AMPLITUDE error message appears when the amplitude discriminator exceeds the programmed AMP. DISCRIM HIGH value. See <b>Service Manual</b> , Chapter 2 for a discussion of error codes.
Delta T Offset	-1000 to 1000 µsec	0 µsec	An offset between the upstream and downstream transit times is specified at this prompt.
Skat T Offset	-500 to 500 µsec	58 µsec	At this prompt, specify a time measurement offset that compensates for any shift resulting from cross-correlation. Set to 0 for active Skat T Offset.
% of Peak	1 to 100%	50%	The percentage of peak used to calculate the transit times and Delta T is specified at this prompt.
M>S Switch	0 to 250 µsec	50 µsec	If the burst mode is set to Skat/Measure (S/M), the meter switches from Skat to Measure Mode when Delta T is less than the M>S_Switch value. <b>DO NOT</b> change this value unless advised to do so by the factory.

**Table 20: Transducer Signal Settings (cont.)**

<b>Transducer Signal Parameters</b>	<b>Range</b>	<b>Default Value</b>	<b>Description</b>
# Shifts	0 to 10	3	The number of shifts corresponds to the actual number of transmits per cycle (number of signals added together in one direction to produce an averaged signal for one interrogation of the fluid) and need only be changed if the environment is very noisy or the acoustic signal is weak.
A Divisor	0.1 to 10	2.5	A Divisor is used to calculate the Measure Mode integrated threshold level and is not normally changed.
# Transmit Pulses	1 to 16	4	# Transmit Pulses specifies the number of pulses in a burst. For difficult conditions (i.e. long paths, high velocity or high temperature), settings as high as 16 may be necessary.
T Window (cycles)	0 to 1000	0	The XGM868i calculates the size of the transmit window based on pipe size and fluid sound speed. However, for diagnostic purposes, the window size may be reset.
R Window (cycles)	10 to 128	10	The XGM868i calculates the size of the receive window based on pipe size and fluid soundspeed. However, for diagnostic purposes, the window size may be reset.

After responding to the above prompt, the meter returns to the SET UP option window.

### C.5.5b The Default Setup Option

Use this option to initialize (reset) all of the parameters within the Set Up Signal menu back to their default values. Complete the following steps to reset all of the parameters:

1. From the Set Up option menu, highlight and double-click on *Default Setup* in the center pane.
  2. Double-click on *No* to keep the current values or on *Yes* to reset all values to their default settings.
- After responding to the above prompt, the meter returns to the Set Up option window.

### C.5.5c The V Averaging Option

Use this option to specify the number of readings that occur before the meter will respond to a step change in flow rate. In general, the smaller the number of readings, the less steady the display will appear. Complete the following steps to set the response time:

1. From the Set Up option menu, highlight and double-click on *V Averaging* in the center pane.
2. Double-click on the desired *Response Time* (from 1 to 60 sec).

For best results, select the *STATS* (statistics) option, as this increases the response time under steady flow conditions while still allowing a rapid response to changes in flow rate.

After responding to the above prompt, the meter returns to the Set Up option window.

### C.5.5d The Advanced Features Option

This option enables you to enable the more advanced features of the meter. In this option you can do the following:

- enter a table of K-factors (based on velocity or reynolds number) that compensates for non-linear flow rates
- enable mass flow (calculated for static fluid density)

#### The Multiple K Factors Option

Use this option to enter a table of K-factors. K-factors are used to create a curve for the flow range (based on velocity or reynolds number) that compensates for non-linear flow rates. The meter accepts from 2 to 20 pairs. Complete the following steps to enter multiple K factors for velocity or reynolds values:

1. From the *Advanced Features* option menu, highlight and double-click on *Multiple K Factors* in the center pane.
2. Double-click on *Yes to Activate Multi K Factors* or on *No* to disable this option.

If NO was selected, the meter returns to the *Advanced Features* window. If YES was selected, proceed to Step 3.

3. Double-click on the desired *Custom Type* (velocity or reynolds).
4. Double-click on *Yes to Edit the K-factor Table* or on *No* to retain the current K-factor table (and return to the *Advanced Features* window).

**Note:** *If the necessary velocity/reynolds vs. K-factor data was not provided with the Model XGM868i's documentation, the K-factor table cannot be edited.*

If NO was selected, the meter returns to the *Advanced Features* window. If YES was selected, proceed to Step 5.

5. Enter the *Number Of K-factors* (from 2 to 20) to be entered into the table, and click [Next Item].

**Note:** *When editing the K-factor table, the velocities must be entered in increasing order.*

6. Enter the *Velocity/Reynolds Value* for K-factor number "X" and click [Next Item].
  7. Enter the *K-factor* corresponding to velocity/reynolds number "X" (0.333 to 3.0) and click [Next Item].
- The *Velocity #* and *K Factor #* prompts repeat for each pair. After entering all the pairs, the meter returns to the *Advanced Features* window.

### C.5.5d The Advanced Features Option (cont.)

#### The Mass Flow Option

Use this option to calculate mass flow from a static fluid density. Complete the following steps to enter the static density of the fluid:

1. From the *Advanced Features* option menu, highlight and double-click on *Mass flow calculation* in the center pane.
2. Double-click on *Yes* to activate *Static Density* or on *No* to disable this option. (If you select *No*, PanaView returns to the *Advanced Features* window.)
3. Double-click the *Density Type* (fluid density (Rho) or molecular weight (Mw)) and click [Next Item].
4. Do one of the following:
  - If you selected Rho - proceed to Step 5.
  - If you selected Mw - proceed to Step 7.
5. Double-click the type of volumetric units (standard - StVOL or actual-AcVOL) for the measurement data display and click [Next Item].
6. Enter the *Fluid Density* (0.00001 to 0.100 lb/ft<sup>3</sup> or 0.00001 to 123.18 kg/m<sup>3</sup>) and click [Next Item]. PanaView returns to the *Advanced Features* window.
7. Enter the *Molecular Weight* and click [Next Item].

After responding to the above prompt, the meter returns to the *Advanced Features* window. Click [Exit Page] three times to return to the *Site Edit Menu*.

## C.6 Entering Data in the Global Menu

The Global menu is used to enter information that is not specific to any of the individual channels. Information programmed via this menu is used to enter several general system parameters (e.g., English or metric units). For meters with 2 channels, this menu is also used to compute parameters such as the sum, difference or average of the channel 1 and channel 2 signals. When calculating the SUM, DIF or AVE readouts, data from the Global-System submenu is used. Any conflicting data entered in the Channel-System submenu is overridden.

The following submenus are included in the Global menu:

- System - use to specify the units of measure used in calculations
- Input/Output - used to set up error handling and to configure analog inputs and outputs
- Comm port - used to set up the serial communications port and MODBUS parameters

To enter the Global menu, double-click on the Global entry in the left pane of the *Site Edit Menu* window. Then proceed to the appropriate section of this chapter for instructions. See Figure 58 on page 132 in Appendix D, *PanaView Menu Maps*, and remember to record all programming data in Appendix B, *Data Records*.

## C.6.1 Entering Global-System Data

While completing these instructions, refer to Figure 58 on page 132 in Appendix D, *PanaView Menu Maps*.

1. In the *Site Data Menu*, double-click on the *Global* entry.
2. Highlight and double-click on the *System* option in the center pane. The window now appears similar to Figure 45.

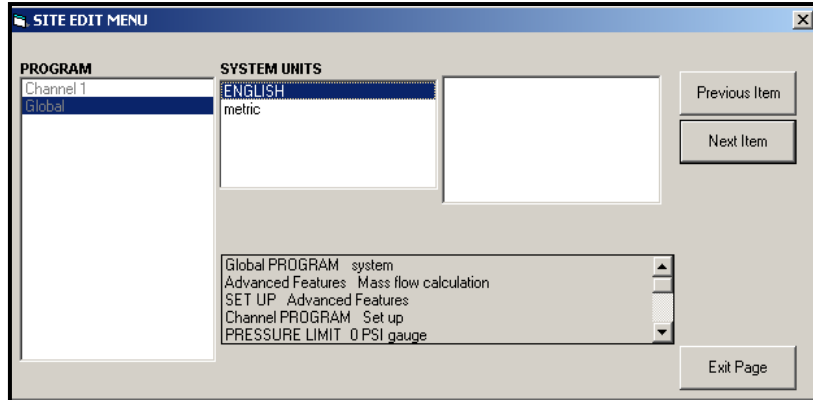

**Figure 45: System Option in the Global Menu**

3. Double-click on the desired *System Units* selection (either metric or English). The XGM868i will display all parameters and measurements in the designated units.
4. Double-click on the desired *Pressure Units* (absolute or gauge) and click [Next Item].
  - a. If gauge was selected, enter the desired *Atmospheric Pressure*, and click [Next Item].
5. Do one of the following:
  - For a single-channel XGM868i, the program returns to the Global program menu. Click [Exit Page].
  - For a 2-channel meter, proceed to step 1 on the next page.

### C.6.1a Volumetric Units

1. Double-click on the desired *Volumetric Units* for the flow rate display. Table 21 lists the available units.

**Table 21: Available Volumetric/Totalizer Units**

English	Metric
Actual Cubic Feet	Actual Cubic Meters
Thousands of ACF	Thousands of ACM
Millions of ACF	Millions of ACM
Standard Cubic Feet	Standard Cubic Meters
Thousands of SCF	Thousands of SCM
Millions of SCF	Millions of SCM

2. Double-click on the desired *Time* units for the flow rate display.
3. Double-click on the desired number of *Vol Decimal Digits* (digits to the right of the decimal point in the volumetric flow rate display).

### C.6.1b Selecting Totalizer Units

1. Double-click on the desired *Totalizer Units* for the totalized flow rate display. Available units are listed in Table 21.
2. Double-click on the desired number of *Tot Decimal Digits* (digits to the right of the decimal point in the totalized flow rate display).
3. Do one of the following:
  - If MASS FLOW is ON, proceed to *Selecting the Mass Flow Units* below.
  - If MASS FLOW is OFF, the meter returns to the Global PROGRAM window. Click [Exit Page] to return to the *Site Edit Menu*.

**Note:** To activate mass flow, refer to page 101. The following prompts will appear only if mass flow is activated for both channels.



### C.6.1c Programming Mass Flow Data

1. Double-click on the desired *Mass Flow* units for flow rate display (listed in Table 22).

**Table 22: Available Mass Flow Units**

English	Metric
Pounds	Kilograms
KiloPounds (Thousands of Pounds)	Tonne = Metric Tons (1000 KG)
MillionPounds	
TONS (2000 LB)	

2. Double-click on the desired *Mass Flow Time* units (from seconds to days).
3. Double-click on the desired number of *MDOT Dec.Digits* (digits to the right of the decimal point) in the mass flow rate display.
4. Double-click on the desired *Mass Totalizer* (units for the totalized mass flow rate display, listed in Table 22).
5. Double-click on the desired number of *Mass Decimal Digits* (digits to the right of the decimal point) in the totalized mass flow rate display.

The XGM868i returns to the Global PROGRAM window. Click [Exit Page] to return to the *Site Edit Menu*.

You have completed entering selections in this option. The program returns to the Global PROGRAM menu.

### C.6.2 Setting Up Inputs and Outputs

Set up the XGM868i's inputs and outputs via the I/O submenu. While following the programming instructions, see Figure 58 on page 132 in Appendix D, *PanaView Menu Maps*. Remember to record all programmed data in Appendix B, *Data Records*. The I/O submenu consists of the following options:

- Error Handling - program the meter's response during an error condition
- Options - set up any option cards and the Slot 0 analog outputs
- Display - set up the LCD display.

To enter the I/O submenu:

1. In the *Site Data Menu*, double-click on the Global entry.
2. Highlight and double-click on the *Input/Output* option in the center pane.

**Note:** In this section, Slot 1 appears as an option only if a suitable option card is installed in Slot 1.

### C.6.2a Setting Up Error Handling

This menu option lets you set how the XGM868i will handle the outputs for measurements and average (two-path) measurements during an error condition. See Chapter 2, *Error Codes*, in the *Service Manual* for a discussion of the built-in error codes.

1. From the Input/Output option, highlight and double-click on the *Error Handling* option in the center pane.
2. Double-click on the desired *Error Handling* selection (as shown in Table 23 and Table 24 on page 107).
  - a. If you selected *Error Level in mA*, enter the *4-20 mA Error Level* (the number of milliamps the analog output will put out during a fault condition). Enter a whole number between 0 and 22, and click [Next Item].

See Table 23 and Table 24 on page 107 for a description of the error handling options available and how the totalizers and display respond to them for a single and two-channel meter.

**Table 23: Error Options and Responses for a Single-Channel Meter**

Option	Output Response	Totalizer Response
Hold Last Value	Holds the last “good” reading	Holds the last “good” reading and continues to totalize, based on that reading
Force Low	Forces the outputs to the low set point	Stops totalizing
Force High	Forces the outputs to the high set point	Stops totalizing
Force High High	Forces the outputs ≈10% above the high set point	Stops totalizing
Error Level in mA	Allows user to enter 4-20 mA error level in mA.	Sends analog outputs to entered mA level when a fault occurs.

## C.6.2b The Error Option

**Table 24: Error Options and Responses for a 2-Channel Meter**

When Measuring	Display Response	Totalizer Response When Error Handling is	
		HOLD	LOW, HIGH, HHIGH
CH1 or CH2 (vel, vol, etc.)	Holds last “good” reading.	Holds last “good” reading and continues to totalize based on that “good” reading.	Stops totalizing.
SUM	Adds two channels using the last “good” reading.	Holds last “good” reading and continues to totalize based on two channels.	Stops totalizing if either or both channels go into error.
DIF	Subtracts two channels using last “good” reading.	Holds last “good” reading and continues to totalize based on two channels.	Stops totalizing if either or both channels go into error.
AVE	See <i>Error Handling for Average Measurements</i> below.		

For a one-channel meter, after responding to the above prompt, the meter returns to the Global I/O prompt shown on the previous page. For a two-channel meter, proceed to step 3 below.

### Error Handling for Average Measurements – AVE

The 2PATH ERROR HANDLING option is intended for applications where two sets of transducers are installed in the same location in the same pipe to improve accuracy and the meter is operated in AVE mode. With this function enabled, the Model XGM868i performs error handling only if both channels are in error. If this function is disabled, error handling occurs when either channel goes into error.

3. Double-click *Yes* to enable *Two-path Error Handling*, or on *No* to disable this function. Specific responses of the display and the totalizer to the two-path error handling option available at the above prompt are listed in Table 25 on the following page.

**Table 25: 2-Path Error Response Options**

Option	Display Response	Totalizer Response
NO	Displays the average of CH1 and CH2, regardless of the error state of either channel.	Outputs the average of CH1 and CH2 totals, regardless of the error state of either channel.
YES	<ol style="list-style-type: none"> <li>If one channel is in error, the other channel’s value is displayed as the average.</li> <li>If both channels are in error, the last average reading is held.</li> </ol>	<ol style="list-style-type: none"> <li>If one channel is in error, totalizing continues.</li> <li>If both channels are in error, totalizing stops.</li> </ol>

After responding to the above prompt, the meter returns to the Input/Output option menu.

### C.6.2c Setting Up Option Cards

The Model XGM868i has two built-in analog outputs, which are assigned to Slot 0. Also, a variety of input/output option cards may be installed in Slot 1. See Chapter 1, *Installation*, of the *Startup Guide* for a complete description of the available option cards.

To access this submenu, double-click on the *Options* entry in the *Input/Output* submenu. This menu option is used to set up and/or scale the inputs and outputs. To accomplish this, complete the following steps:

- Double-click on the desired *I/O Slot* to program the *I/O* functions in that slot.

**Note:** *If an option card is not installed in Slot 1, the Slot1 option does not appear at the above prompt.*

Proceed to the appropriate section for programming instructions specific to the type of input or output selected above.

#### Analog Outputs

Complete the following steps to set up the analog outputs for any slot (refer to Figure 58 on page 132):

1. Double-click on the desired *Output* (A or B).

**Note:** *The set up of output A is used here as an example. Identical procedures would be used to set up output B.*

2. Double-click on *Off* to disable Output A and return to step 1, or on *0-20 mA* or *4-20 mA* to specify the desired range for output A.

**Note:** *For a 1-Channel meter, proceed to step 4.*

3. Double-click on the desired *Channel* option. See Table 26 for a description of the channel options available.

**Table 26: Channel Options**

Option	Description
Channel 1	Channel 1
Channel 2	Channel 2
Add Channels	CH1+CH2
Subtract Channels	CH1-CH2
Average Channels	$(CH1+CH2)/2$

4. Double-click on the desired *Measurement Name*. (Table 27 on page 41 provides a description of the available parameters.)

**Analog Outputs (cont.)**

**Note:** All the options shown below will appear only if Mass Flow is activated.

**Table 27: Available Measurement Parameters**

Option Bar	Description	Good	Bad
Velocity	Displays the flow velocity.	N.A.	N.A.
Volumetric	Displays the volumetric flow.	N.A.	N.A.
FWD Total	Displays the forward totalized volume flow.	N.A.	N.A.
REV Total	Displays the reverse totalized volume flow.	N.A.	N.A.
Time	Displays the total flow measurement time.	N.A.	N.A.
Mass Flow	Displays the mass flow.	N.A.	N.A.
FWD Mass	Displays the forward totalized mass flow.	N.A.	N.A.
REV Mass	Displays the reverse totalized mass flow.	N.A.	N.A.
UP Sig Strength	Displays the signal strength for the upstream transducer.	50–75	<50 or >75
DN Sig Strength	Displays the signal strength for the downstream transducer.	50–75	<50 or >75
Soundspeed	Displays the measured speed of sound in the gas.	N.A.	N.A.
UP Transit	Displays the upstream ultrasonic signal transit time.	N.A.	N.A.
DN Transit	Displays the downstream ultrasonic signal transit time.	N.A.	N.A.
Delta T	Displays the transit time difference between the upstream and downstream signals.	N.A.	N.A.
K(Re)*Multi K*K Factor	K factor, based on the Reynolds number.	N.A.	N.A.
PEAK%	Displays the percentage of peak (set to +50 by default).	N.A.	N.A.
UP Signal Q	Displays the signal quality for the upstream transducer.	Š 1200	–400 to +400
DN Signal Q	Displays the signal quality for the downstream transducer.	Š 1200	–400 to +400
UP Amp Discrim	Displays the value for the signal amplitude of the upstream transducer.	24 ± 5	<19 or >29
DN Amp Discrim	Displays the value for the signal amplitude of the downstream transducer.	24 ± 5	<19 or >29
UP DAC COUNTS	Displays the AGC DAC count for the upstream gain setting.	N.A.	N.A.
DN DAC COUNTS	Displays the AGC DAC count for the downstream gain setting.	N.A.	N.A.
UP + Peak	Displays signal peaks for the upstream transducer.	100–2300	<100 or >2300
DN + Peak	Displays signal peaks for the downstream transducer.	100–2300	<100 or >2300
Temperature	Displays the gas temperature (from 0/4–20 mA input).	N.A.	N.A.
Pressure	Displays the gas pressure (from 0/4–20 mA input).	N.A.	N.A.
Act Vol.	Displays actual volumetric flow.	N.A.	N.A.
Std Vol.	Displays standard volumetric flow.	N.A.	N.A.
Up Transit S <sup>1</sup>	Displays Skan transit time upstream.	N.A.	N.A.
Dn Transit S <sup>1</sup>	Displays Skan transit time downstream.	N.A.	N.A.
Delta T S <sup>1</sup>	Displays Skan Delta T.	N.A.	N.A.
Up Transit M <sup>1</sup>	Displays Measure transit time upstream.	N.A.	N.A.

**Table 27: Available Measurement Parameters**

Option Bar	Description	Good	Bad
Dn Transit M <sup>1</sup>	Displays Measure transit time downstream.	N.A.	N.A.
Delta T M <sup>1</sup>	Displays Measure Delta T.	N.A.	N.A.
Vinst	Displays the instantaneous velocity.	N.A.	N.A.
<sup>1</sup> available only if Burst Mode = S/M			

**Note:** *The measurement units that appear in these prompts are those selected in the Global-System menu earlier in this section.*

5. Enter a flow rate value for the *Zero* (low) end of the analog output range and click [Next Item].

6. Enter a flow rate value for the *Full* (high) end of the analog output range and click [Next Item].

After responding to the above prompt, the meter returns to step 1. Click [Exit Page] to proceed to another menu or option.

## C.6.2c Setting Up Option Cards (cont.)

### Option Card Analog Inputs

Complete the following steps to set up the analog inputs of an option card installed in Slot 1 (refer to Figure 58 on page 132):

1. Double-click on the desired *Input* (A, B, C or D).

**Note:** *The setup of input A is used as an example. Identical procedures would be used to set up the remaining inputs.*

2. Enter a *Label* of up to eight characters for input A and click on [Next Item].
3. Double-click on *Off* to disable Input A and return to step 1, or on *Temp* or *Spec* to designate it as a temperature or special input.
  - OFF

If OFF was selected to disable input A, the meter returns to the *Input* prompt in step 1. Double-click on another input, or click [Exit Page] to move to another menu.

- TEMP or PRESR

If TEMP or PRESR was selected to set up input A as a live temperature or pressure input, complete steps 4 and 5 below:

4. Enter a value for the *Base* (low) end of the analog input range and click [Next Item].
5. Enter a value for the *Full Scale* (high) end of the analog input range and click [Next Item].

After responding to the above prompt, the meter returns to step 1. Click [Exit Page] to proceed to another menu or option.

- SPEC

If SPEC was selected to set up input A as a live special input, complete steps 6 through 10 below:

6. Enter a *Name* for input A and click [Next Item].
7. Enter the *Units* of measurement for input A and click [Next Item].
8. Enter a temperature value for the *Base* (low) end of the analog input range and click [Next Item].
9. Enter a temperature value for the *Full Scale* (high) end of the analog input range and click [Next Item].

After responding to the above prompt, the meter returns to step 1. Click [Exit Page] to proceed to another menu or option.

## C.6.2c Setting Up Option Cards (cont.)

### Option Card RTD Inputs

Option cards with RTD inputs have a temperature range of -148° to 660°F (-100° to 350°C). Complete the following steps to set up the RTD inputs of an option card installed in Slot 1 (refer to Figure 58 on page 132):

1. Double-click on the desired *Input* (A, B, C or D).

**Note:** *The setup of RTD input A is used here as an example. Identical procedures would be used to set up the remaining RTD inputs.*

2. Enter a *Label* of up to eight characters for input A and click [Next Item].
3. Double-click on *Off* to disable Input A and return to step 1, or on *Temp* to enable input A as a live temperature input.
4. Enter a temperature value for the *Zero* (low) end of the analog input range and click [Next Item].
5. Enter a temperature value for the *Full Scale* (high) end of the analog input range and click [Next Item].

After responding to the above prompt, the meter returns to step 1. Click [Exit Page] to proceed to another menu or option.



**Option Card Alarm Relays**

Complete the following steps to set up the alarm relays of an option card installed in Slot 1 (refer to Figure 58 on page 132):

1. Double-click on the desired *Output* (A, B, C or D).  
**Note:** *The set up of alarm A is used here as an example. Identical procedures would be used to set up the additional alarms.*
2. Double-click on *Off* to disable Output A and return to step 1, or on *High, Low or Fault* to select the desired alarm type.
3. Double-click on *No* for standard alarm operation, or on *Yes* for *Failsafe* operation. (See Chapter 1, *Installation*, of the *Startup Guide* for failsafe wiring instructions.)  
 For a I-Channel meter, proceed to step 5.
4. Double-click on the desired *Channel* option. See Table 28 for a description of the channel options available.

**Table 28: Channel Options**

Option	Description
Channel 1	Channel 1
Channel 2	Channel 2
Add Channels	CH1+CH2
Subtract Channels	CH1-CH2
Average Channels	$(CH1+CH2)/2$

**Note:** *If FAULT was selected as the alarm type, the next two prompts do not appear. You have completed entering data in this option.*

5. Double-click on the desired *Measurement Name*. (Table 27 on page 41 provides a description of the available parameters.)  
**Note:** *The measurement units that appear in these prompts are those selected in the Global-System menu earlier in this section.*
6. Enter a value for the *Trigger Point* of the alarm and click [Next Item].
7. Double-click on the type of *Error* (flow, non-flow or both) that will trigger the fault alarm and press [Enter].  
 After responding to the above prompt, the meter returns to step 1. Click [Exit Page] to proceed to another menu or option.

## C.6.2c Setting Up Option Cards (cont.)

### Option Card Totalizer Outputs

This type of output issues one pulse per selected volume of flow. The meter produces a pulse each time the programmed amount of flow passes through the pipe. Complete the following steps to set up the totalizer outputs of an option card installed in Slot 1:

1. Double-click on the desired *Output* (A, B, C or D).

**Note:** *The set up of output A is used as an example. Identical procedures would be used to set up the other outputs.*

2. Double-click on *Off* to disable Output A and return to step 1, or on *Totalizer* to set up output A as a totalizer output. For a 1-Channel meter, skip to step 4.

3. Double-click on the desired *Channel* option. See Table 28 on the previous page for a description of the channel options available at the above prompt.

4. Double-click on the desired *Measurement Name*, as listed in Table 29.

**Table 29: Output Measurement Options**

Forward Totalized Volume Flow
Reverse Totalized Volume Flow
Forward Totalized Mass Flow
Reverse Totalized Mass Flow

**Note:** *The measurement units that appear in these prompts are those selected in the Global-System menu earlier in this section.*

5. Enter a value between 50  $\mu\text{sec}$  and 500,000  $\mu\text{sec}$  for *Pulse On Time* (the frequency of the totalizer pulses) and click [Next Item].

**Note:** *A complete pulse consists of equal amounts of ON and OFF times. Choose a value that is compatible with the counter to be used.*

6. Enter a value for the number of measurement units represented by each pulse, and click [Next Item]. After responding to the above prompt, the meter returns to step 1. Click [Exit Page] to proceed to another menu or option.

### Option Card Frequency Outputs

This type of output produces a frequency pulse that is proportional to the output measurement. Complete the following steps to set up the frequency outputs of an option card installed in Slot 1 (see Figure 58 on page 132):

1. Double-click on the desired *Output* (A, B, C or D).

**Note:** *The set up of output A is used as an example. Identical procedures would be used to set up the other outputs.*

2. Double-click on *Off* to disable Output A and return to step 1, or on *Frequency* to set up output A as a frequency output.

For a 1-Channel meter, skip to step 4.

3. Double-click on the desired *Channel* option. See Table 28 on page 113 for a description of the channel options available at the above prompt.

4. Double-click on the desired *Measurement Name*. (Table 27 on page 41 provides a description of the available parameters.)

**Note:** *The measurement units that appear in these prompts are those selected in the Global-System menu earlier in this section.*

5. Enter a flow rate value for the *Zero* (low) end of the frequency output range and click [Next Item].

6. Enter a flow rate value for the *Full* (high) end of the frequency output range and click [Next Item].

7. Enter a value between 1 and 10,000 for the *Full Scale Frequency* and click [Next Item].

After responding to the above prompt, the meter returns to step 1. Click [Exit Page]:

- once to return to the Global I/O option:
- twice to return to the Global PROGRAM option:
- three times to return to the *Site Edit Menu*:
- four times to exit the *Site Edit Menu*.

### C.6.2d Programming the LCD

Through PanaView, you can program the LCD display to display up to four variables in sequence. Complete the following steps to program the LCD display:

**Note:** When you first initialize the XGM868i, the number of LCD parameters is set to OFF. You must program the LCD to display any measured parameters.

1. From the Input/Output option, highlight and double-click on the *Display* option in the center pane.
2. The first prompt asks for the # of LCD Parameters. Double-click on the desired number (from OFF through 1-4 and KEY).

The OFF setting switches the measurement display off, while the KEY setting enables users to change the measurement display via the arrow keys, without accessing the *Keypad Program*. If you select KEY:

- To view a parameter other than the one currently displayed, press the [ $\Delta$ ] or [ $\nabla$ ] keys to scroll through the various parameters.
- To scroll through the channel options on a two-channel XGM868i, press the [ $\triangleleft$ ] and [ $\triangleright$ ] keys until you have reached the desired option.

**Note:** For a 1-channel XGM868i, skip to step 4.

3. Scroll to the desired *Channel option*, as listed in Table 30.

**Table 30: Channel Options**

Option	Description
CH1	Channel 1
CH2	Channel 2
SUM	CH1+CH2
DIF	CH1-CH2
AVE	$(CH1+CH2)/2$

4. For each channel, select the desired *Measurement Parameter*, as shown in Table 27 on page 41.
5. Repeat steps 3 and 4 for each parameter. PanaView returns to the Global I/O menu.

### C.6.3 Entering Communications Data

The Model XGM868i flowmeter is equipped with an RS232 or an RS485 serial interface. An RS485 option is also available with MODBUS capability. When the MODBUS option is present, the XGM868i may also have the standard RS232 serial interface.

The serial port is used to transmit stored data and displayed readings to a personal computer by connecting the meter's serial interface to the serial port of the PC. In addition, the Model XGM868i can receive and execute remote commands, using *PanaView* software, via this link.

Use the Comm port submenu to set the communications port and MODBUS parameters. While following the programming instructions, refer to Figure 57 on page 131 of Appendix D, *PanaView Menu Maps*.

#### C.6.3a Setting Up the Serial Port

1. To enter this submenu from the Global menu, highlight and double-click on the *Comm port* option in the center pane.
2. Enter a *Meter Address* number between 1 and 254 and click [Next Item]. The default number is 1. A meter address is only necessary for communication with the Panametrics *PanaView* software. See the *PanaView User's Manual* for more information.

**IMPORTANT:** *If the meter address or baud rate is changed, communication with PanaView must be re-established with the new address number.*

3. Double-click on the desired *Baud Rate* (from 300 to 19,200).  
If you have the RS485 MODBUS option, proceed to step 4 below. If you have the standard RS232 serial interface, the meter exits the Comm port submenu and returns to the Global PROGRAM prompt.

**Note:** *The XGM868i MODBUS communication settings chosen in the next four steps must match those of the MODBUS control system.*

4. Double-click on the desired *MODBUS Baud Rate* (from 2400 to 9600).
5. Double-click on the desired *MODBUS Parity* (None, Odd or Even).
6. Double-click on the desired *MODBUS Stop Bits* (1 or 2).
7. Enter the desired *MODBUS Address*.

The meter exits the Comm port submenu and returns to the Global window. Click [Exit Page] once to return to the *Site Edit Menu*, and [Close] to exit the *Site Edit Menu*.

**IMPORTANT:** *You must reboot the XGM868i to load the new settings.*

Refer to the section *Requesting Parameters Using MODBUS* on the following page to retrieve data from the XGM868i using MODBUS.

### C.6.3b Requesting Parameters Using MODBUS

To request specific parameters from the XGM868i via the MODBUS, the control system must access the appropriate register number, as shown in Table 31. Only registers 1–84 are available with the XGM868i for MODBUS communications. Registers 508–512 are used by the XGM868i to store the MODBUS parameters.

**Table 31: MODBUS Registers**

MODBUS Reg #	DPR Hex Addr	Description	Units	Scaling (decimal places)	Size in Bytes
1		<sup>1</sup> Clear Totalizers	none	--	2 (16 bit signed)
2		CH1 Velocity	ft/s or m/s	2	4 (32 bit integer)
4		CH1 Volumetric	VOL_U	--	4 (IEEE 32 bit)
6		CH1 +Totals	TOT_U	Register 10	4 (32 bit integer)
8		CH1 -Totals	TOT_U	Register 10	4 (32 bit integer)
10		CH1 #T Digits	none	0	2 (16 bit integer)
11		CH1 Totalizer Time	sec	2	4 (32 bit integer)
13		<sup>2</sup> CH1 Error Value	none	0	2 (16 bit integer)
14		CH 1 SSUP	none	1	4 (32 bit integer)
16		CH 1 SSDN	none	1	4 (32 bit integer)
18		CH 1 SNDSP	ft/s or m/s	0	4 (32 bit integer)
20		CH 2 Velocity	ft/s or m/s	2	4 (32 bit integer)
22		CH 2 Volumetric	VOL_U	--	4 (IEEE 32 bit)
24		CH 2 +Totals	TOT_U	Register 28	4 (32 bit integer)
26		CH 2 -Totals	TOT_U	Register 28	4 (32 bit integer)
28		CH2 # T Digits	none	0	2 (16 bit integer)
29		CH2 Totalizer Time	sec	2	4 (32 bit integer)
31		<sup>2</sup> CH2 Error Value	none	0	2 (16 bit integer)
32		CH 2 SSUP	none	1	4 (32 bit integer)
34		CH 2 SSDN	none	1	4 (32 bit integer)
36		CH 2 SNDSP	ft/s or m/s	0	4 (32 bit integer)
38		<sup>3</sup> AVG Velocity	ft/s or m/s	2	4 (32 bit integer)
40		<sup>3</sup> AVG Volumetric	VOL_U	--	4 (IEEE 32 bit)
42		<sup>3</sup> AVG+Totals	TOT_U	Register 46	4 (32 bit integer)
MODBUS Reg #	DPR Hex Addr	Description	Units	Scaling (decimal places)	Size in Bytes
44		<sup>3</sup> AVG-Totals	TOT_U	Register 46	4 (32 bit integer)
46		AVG #T Digits	none	0	2 (16 bit integer)
47		<sup>3</sup> AVG Totalizer Time	sec	2	4 (32 bit integer)
49		<sup>4</sup> AVG Error Value	none	0	2 (16 bit integer)
50		<sup>3</sup> AVG SSUP	none	1	4 (32 bit integer)
52		<sup>3</sup> AVG SSDN	none	1	4 (32 bit integer)
54		<sup>3</sup> AVG SNDSP	ft/s or m/s	0	4 (32 bit integer)

**Table 31: MODBUS Registers**

56		CH1 Power	Power_u	--	4 (IEEE 32 bit)
58		CH1 +Energy	Energy_u	Register 62	4 (32 bit integer)
60		CH1 -Energy	Energy_u	Register 62	4 (32 bit integer)
62		CH1 # Energy Digits	none	0	2 (16 bit integer)
63		CH1 TempS	°F or °C	2	4 (32 bit integer)
65		CH1 TempR	°F or °C	2	4 (32 bit integer)
67		CH1 TS-TR	°F or °C	2	4 (32 bit integer)
69		CH1 DELTH	Btu/lb or J/gm	2	4 (32 bit integer)
71		CH2 Power	Power_u	--	4 (IEEE 32 bit)
73		CH2 +Energy	Energy_u	Register 77	4 (32 bit integer)
75		CH2 -Energy	Energy_u	Register 77	4 (32 bit integer)
77		CH2 # Energy Digits	none	0	2 (16 bit integer)
78		CH2 TempS	°F or °C	2	4 (32 bit integer)
80		CH2 TempR	°F or °C	2	4 (32 bit integer)
82		CH2 TS-TR	°F or °C	2	4 (32 bit integer)
84		CH2 DELTH	Btu/lb or J/gm	2	4 (32 bit integer)
508	3F6	<sup>5</sup> MODBUS baud rate	none	0	2 (16 bit integer)
509	3F8	<sup>6</sup> MODBUS parity	none	0	2 (16 bit integer)
510	3FA	<sup>7</sup> MODBUS stop bits	none	0	2 (16 bit integer)
511	3FC	MODBUS meter addr	none	0	2 (16 bit integer)
512	3FE	RESERVED	none	---	---

### C.6.3b Requesting Parameters Using MODBUS (cont.)

Notes:

1. **Clear Totalizers:** flag from the 8051 to clear totalizers in the 68332 memory.
2. **Error Value:** see table in XGM868i manual for error codes
3. **Average:**  
average of channel 1 and channel 2 if both channels out of error,  
channel 1 value if channel 2 is in error,  
channel 2 value if channel 1 is in error,  
zero if both channels in error.
4. **Average Error Status:**  
0 = both in error  
1 = chan 2 in error,  
2 = chan 1 in error,  
3 = both ok
5. **MODBUS baud rate:**  
5 = 2400, 6 = 4800, 7 = 9600
6. **MODBUS parity:**  
0 = none, 1 = odd, 2 = even
7. **MODBUS stop bits:**  
1 = 1 stop bit, 2 = 2 stop bits
8. **General:**  
Registers are written if corresponding functions are actuated by the user. Registers for unactuated functions are initialized to zero at startup.



### C.6.3c Activating Security in the Global Menu

In order to prevent unauthorized tampering with the flowmeter’s programming, the XGM868i is equipped with a security feature that locks all the keys except [PROG] (which, when pressed, requires the password).

When the system is locked, access to the menus will be denied unless the correct password is entered. The XGM868i is shipped with a default password (2719 and three spaces). For increased security, the default password should be changed.

**Note:** *Once the system has been locked, it can only be unlocked by entering the password, because access to the SECUR submenu is restricted.*

While completing these instructions, refer to the menu map in Figure 57 on page 131.

1. In the *Site Data Menu*, double-click on the Global entry. If the system is unlocked, the window appears similar to Figure 46 below. Highlight and double-click on the Security option in the center pane.

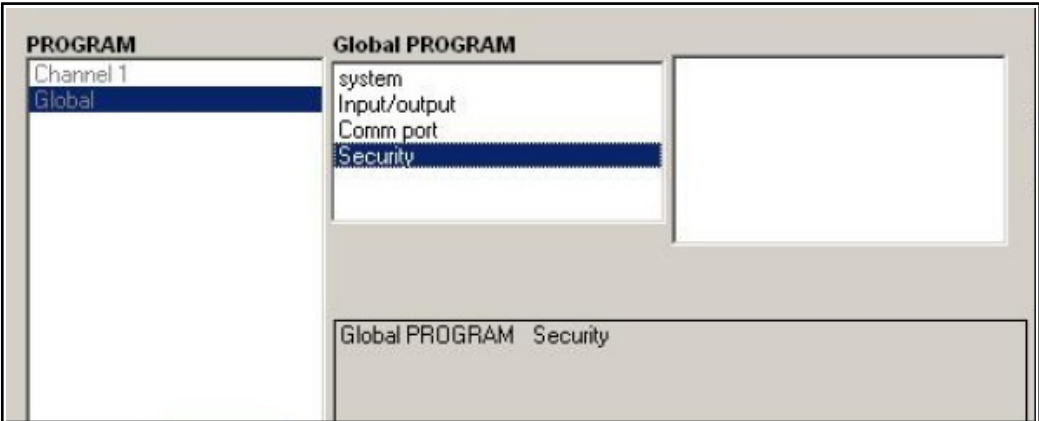

Figure 46: Global Menu with Security Option Highlighted

2. If the system is locked, the window is similar to Figure 47 below.

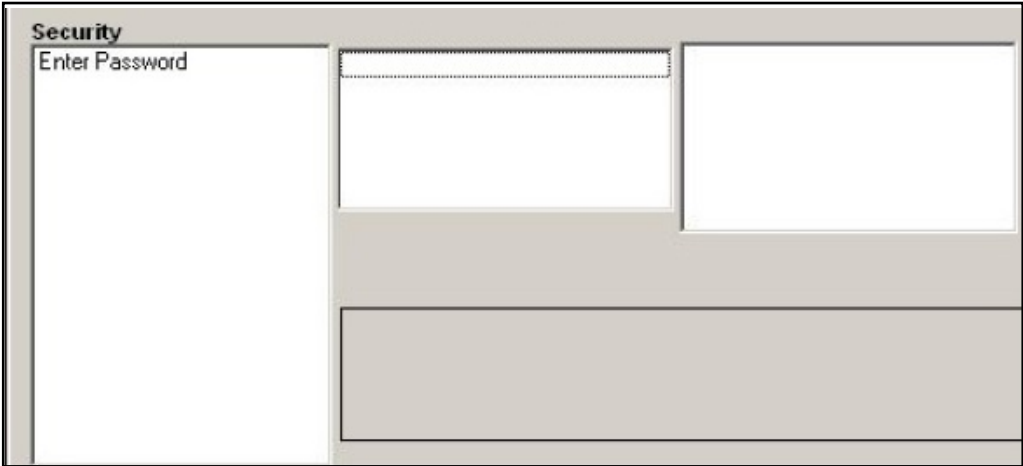
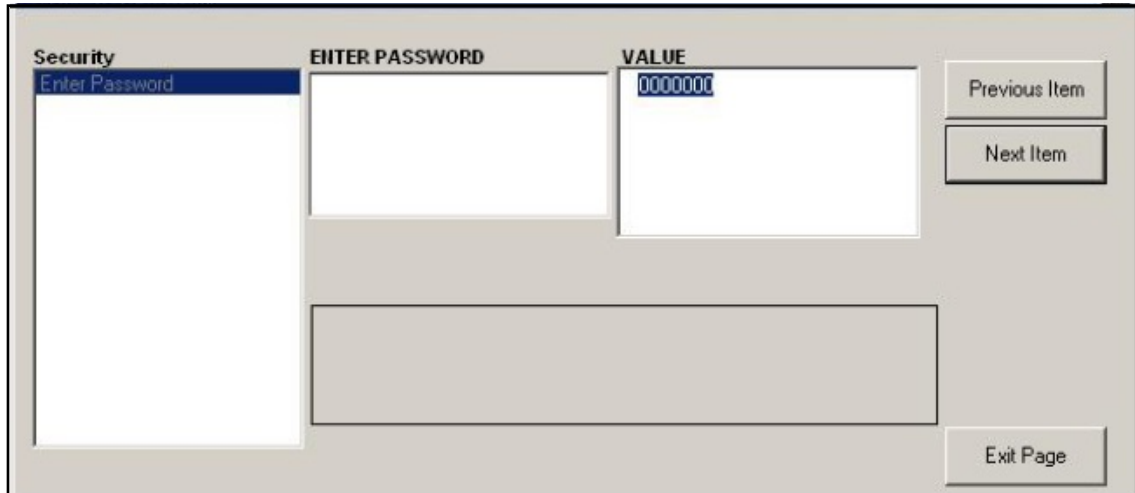

Figure 47: Password Window

### C.6.3c Activating Security in the Global Menu (cont.)

3. Enter the current or default Password and click [Next Item].



**Figure 48: Entering Password**

4. At the Lock Out prompt, click UNlck to unlock the system and return to the initial PROGRAM menu, or click LOCK to lock the system.
5. At the Edit Password prompt, click No to leave the password unchanged, or click YES to enter a new password.  
**IMPORTANT:** *Since the default password is printed in this manual, a new password should be entered. If the password is ever lost, contact the factory for assistance.*
6. Enter the New Password and click Yes. Any combination of letters and numbers up to a total of 7 characters may be used as a password.
7. Verify the New Password by re-entering it and click Yes. Be sure to record the new password in a safe place.

## C.7 Exiting the Site Edit Menu

After leaving the Global submenu, PanaView returns to the *Site Edit Menu*. Click [Close] to exit the *Site Edit Menu*. Then proceed to Chapter 3, *Operation*, of the *Startup Guide* for instructions on taking measurements, or refer to the appropriate chapters of this manual for detailed instructions on using the other features of the XGM868i flow transmitter.

### C.8 Saving Site Data

The XGM868i holds setup parameters for a single internal site, called *Working*. Through PanaView, users can store site file data in a PC and reload it into the XGM868i. To save or reload site data via PanaView:

- 1. In the *New Meter Browser*, highlight the XGM868i.
- 2. Right-click on the highlighted XGM868i and select the *Properties* option, as shown in Figure 49.

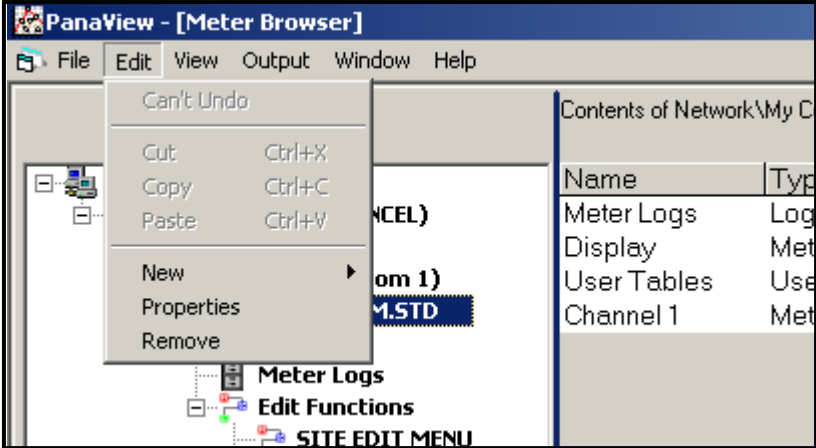

Figure 49: Properties Option

The window now appears similar to Figure 50.

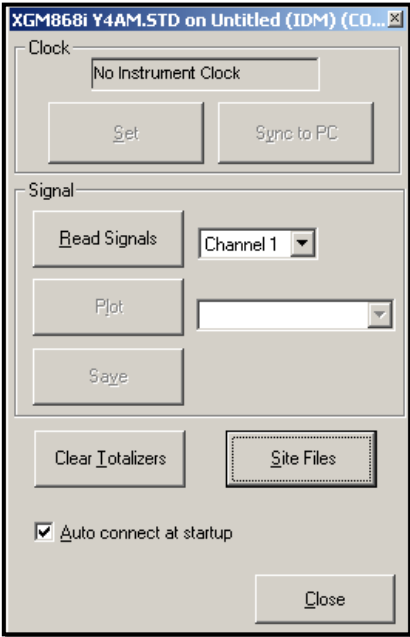

Figure 50: Properties Window

## C.8 Saving Site Data (cont.)

- Click on the [Site Files] button. The *Site File Operations* window (shown in Figure 51) opens.

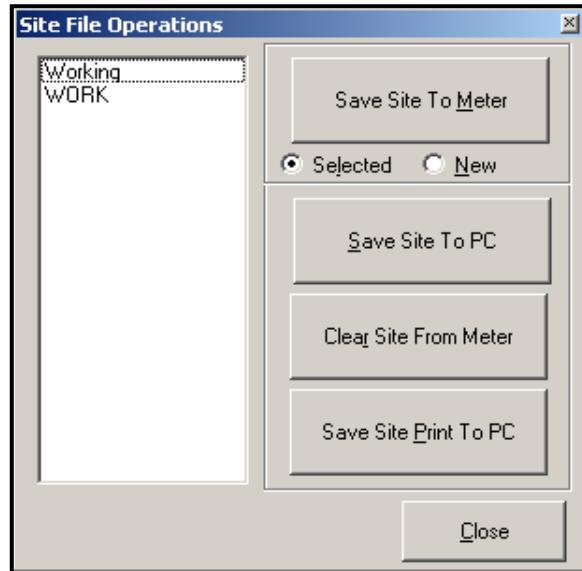

Figure 51: *Site File Operations* Window

### C.8.1 Saving Current Site Data to the Meter

To save existing site data to the meter:

- Select the radio button for *Selected* and highlight an existing site in the left pane.
- Then click on the [Save Site to Meter] button. A screen opens similar to Figure 52.

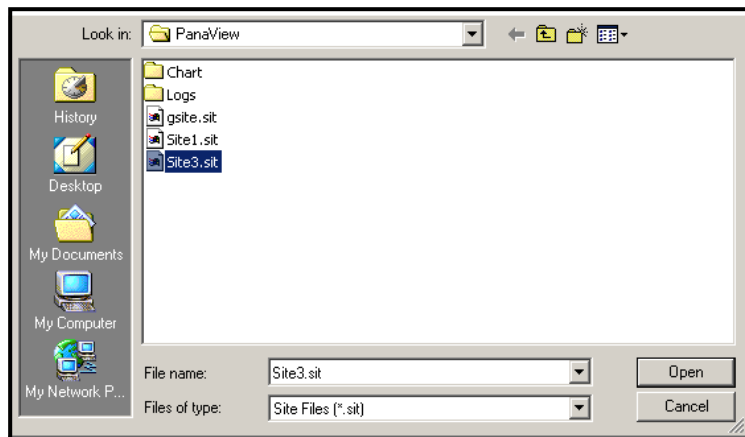

Figure 52: *Site File Selection*

- Highlight the desired site and click [Open]. PanaView sends the site to the meter.

## C.8.2 Saving New Site Data to the XGM868i

To save new site data to the meter:

1. Select the radio button for *New* and click on the [Save Site to Meter] button.
2. A window opens similar to Figure 53. Enter the desired name, and click [OK].

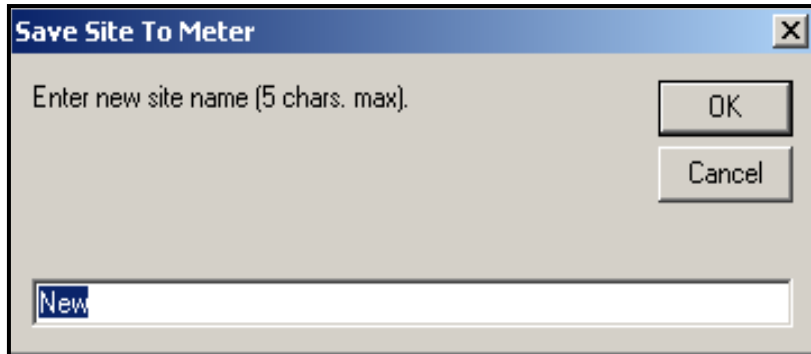

**Figure 53: Site Name Entry Window**

3. The *Site File Selection* window (Figure 52 on page 124) opens. Highlight a site file with the desired settings, and click [Open]. The site file becomes the *Working* site in the meter with the desired settings.

## C.8.3 Saving a Site to the PC

To save a site to the PC:

1. Highlight the desired site in the left pane. (See Figure 51 on page 124.)
2. Click [Save Site to PC]. A window opens similar to Figure 52 on page 124.
3. Enter the desired site name and click [Save]. PanaView saves the site in the PanaView folder unless otherwise specified.

**Note:** *If you have created a site on the meter after opening the Site File Operations window, you must close and reopen the window to click on the new site.*

## C.8.4 Clearing a Site from the Meter

As the XGM868i has only one site (*Working*) at any time, it is not possible to remove this site. To change site parameters, first save a site to the PC (as discussed in *Saving a Site to the PC* on the previous page), and then save the site to the XGM868i (as discussed in *Saving New Site Data to the XGM868i* on the previous page).

## C.8.5 Saving Site Data in Text Form

To store the data from a site file as a text file for display or printout:

1. Highlight the site in the left pane. (See Figure 52 on page 124.)
2. Click on [Save Site Print to PC].
3. The *Site File Selection* window (shown in Figure 52 on page 124) opens. Enter the desired site name (now with a .prt suffix) and click on [Save]. PanaView displays a text version of the site, as shown in Figure 54.

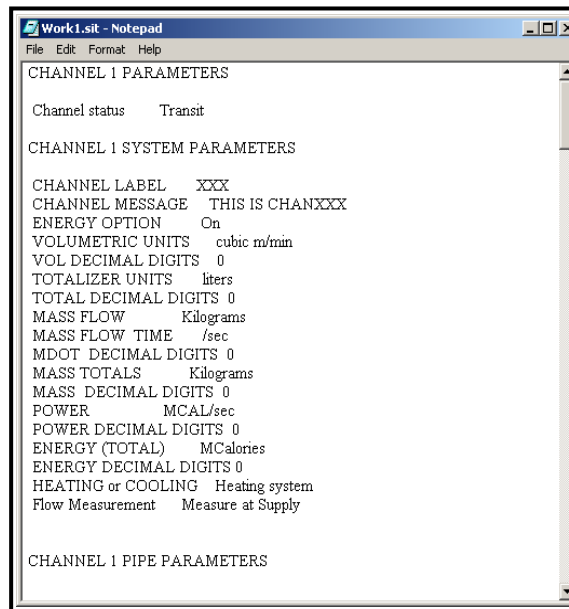

```

Work1.sit - Notepad
File Edit Format Help
CHANNEL 1 PARAMETERS
Channel status      Transit

CHANNEL 1 SYSTEM PARAMETERS

CHANNEL LABEL      XXX
CHANNEL MESSAGE    THIS IS CHANXXX
ENERGY OPTION      On
VOLUMETRIC UNITS   cubic m/min
VOL DECIMAL DIGITS 0
TOTALIZER UNITS    liters
TOTAL DECIMAL DIGITS 0
MASS FLOW          Kilograms
MASS FLOW TIME     /sec
MDOT DECIMAL DIGITS 0
MASS TOTALS       Kilograms
MASS DECIMAL DIGITS 0
POWER              MCAL/sec
POWER DECIMAL DIGITS 0
ENERGY (TOTAL)    MCalories
ENERGY DECIMAL DIGITS 0
HEATING or COOLING Heating system
Flow Measurement   Measure at Supply

CHANNEL 1 PIPE PARAMETERS
  
```

**Figure 54: Printout of Site File**

4. Click [Close] once to close the *Site File Operations* window, and a second time to close the *Properties* window and return to the *Meter Browser*.

## Appendix D. PanaView Menu Maps for the XGM868i





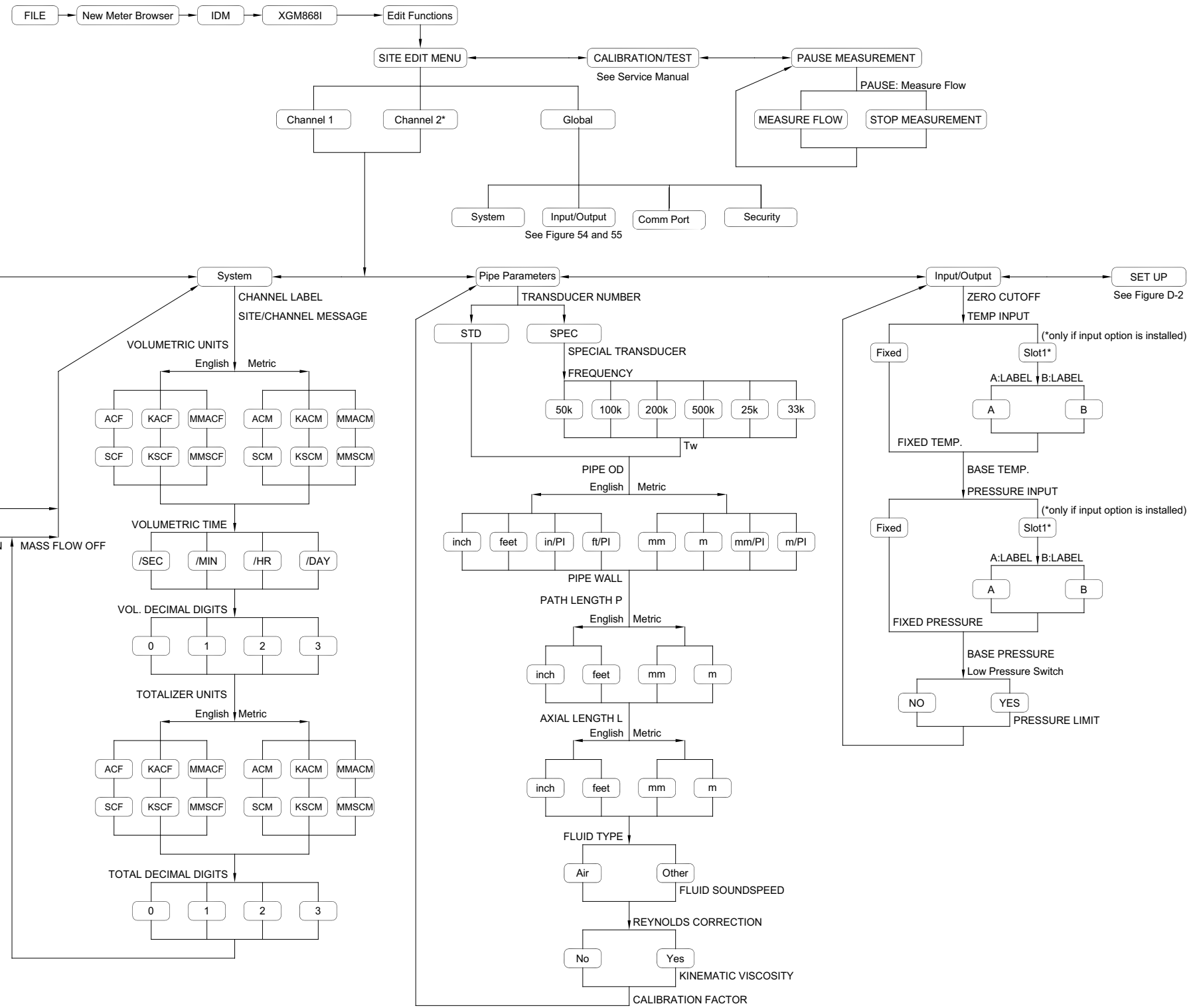

Figure 55: Channel X Menu - Status, System, Pipe and Input/Output Options

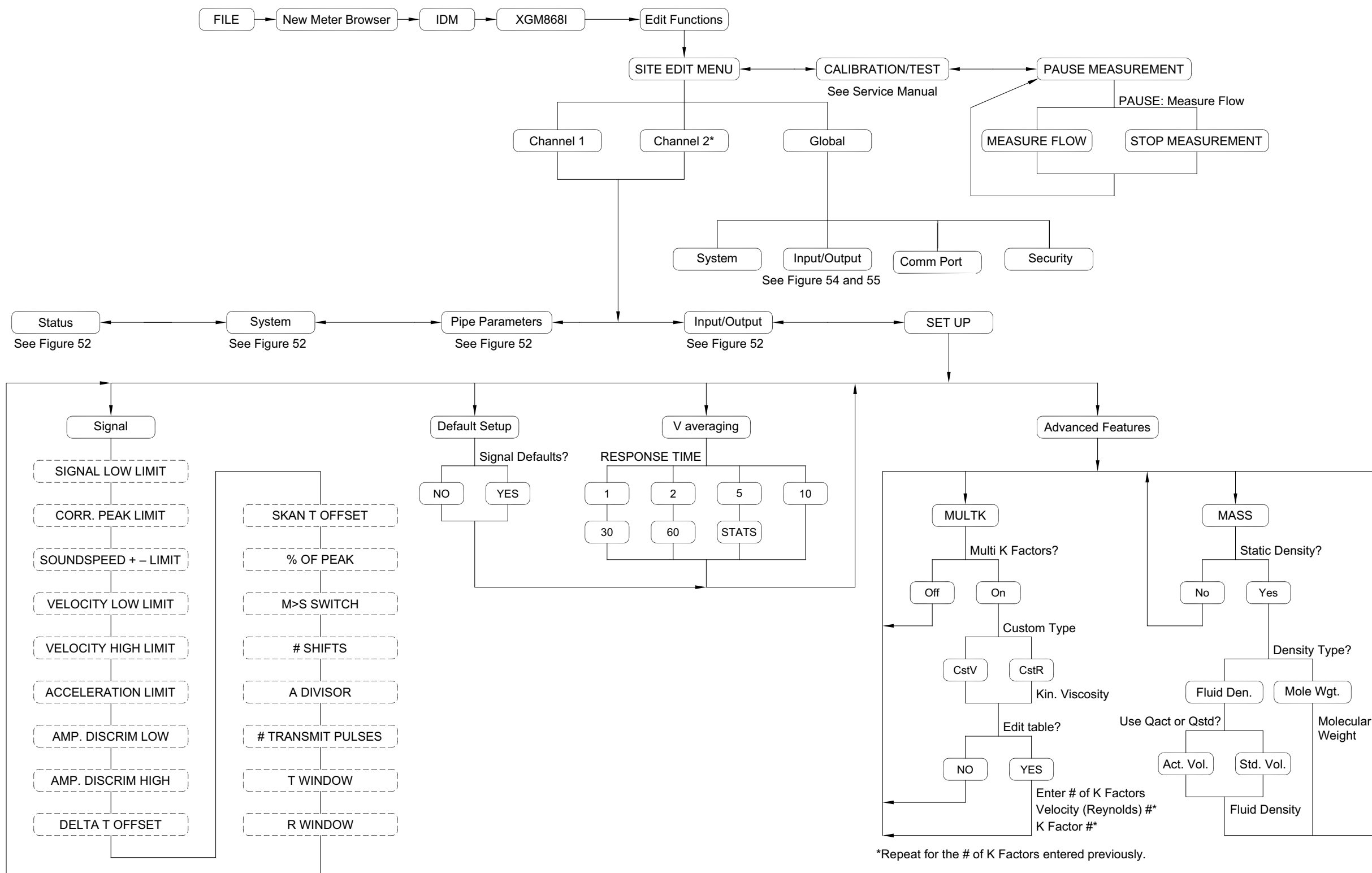

Figure 56: Channel X Menu - Set Up Option

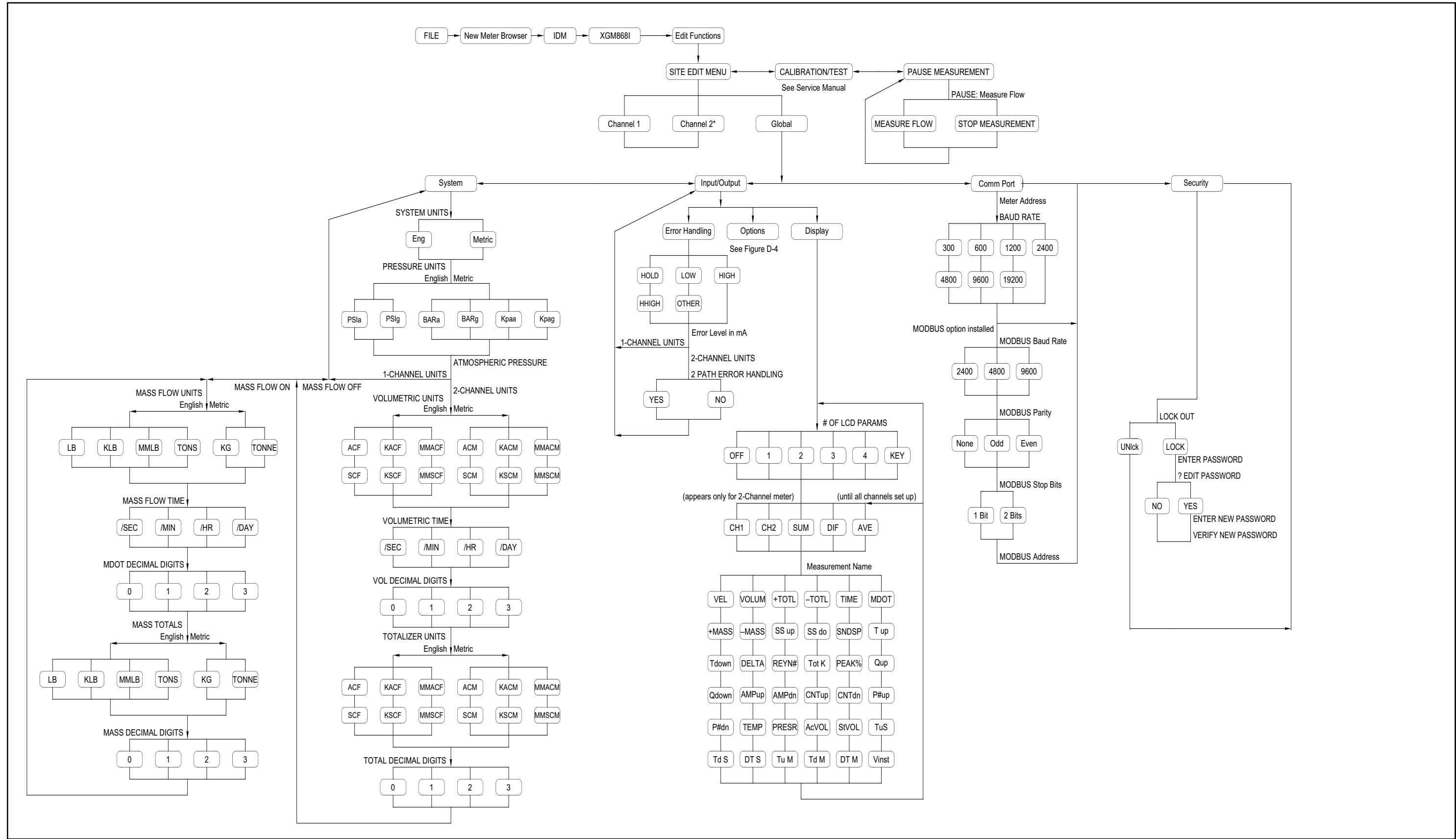
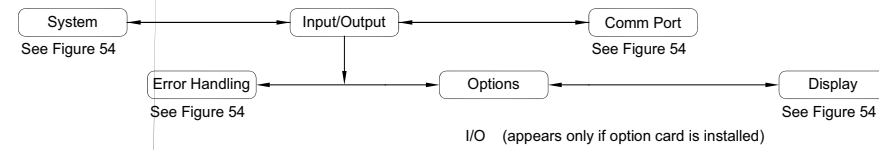
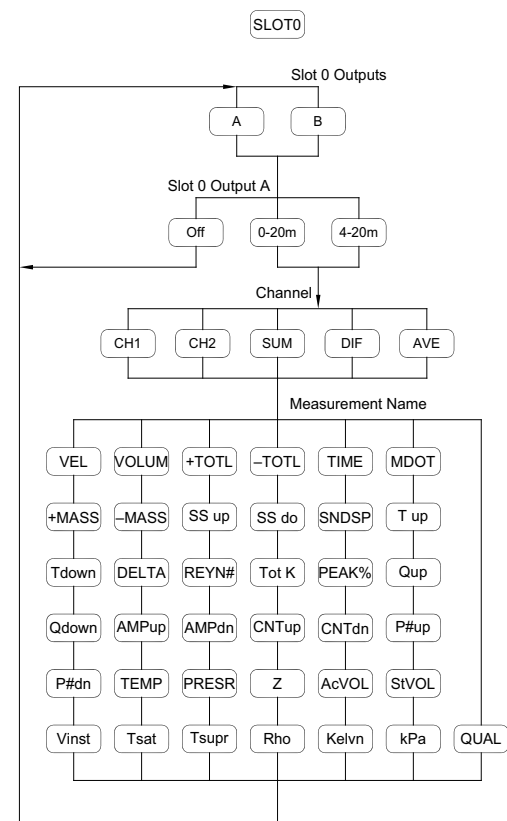
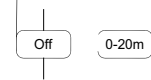

Figure 57: Global Menu - System, Display and Comm Port Options



**SLOT1**



## Appendix E. Foundation Fieldbus Communications

### E.1 Introduction

Foundation Fieldbus provides a means of communicating with the flowmeter. The patent numbers which apply are 5,909,363 and 6,424,872.

This Foundation Fieldbus device supports 6 Analog Input (AI) blocks, which can be configured to supply the following measurements on the network (see Table 32).

**Table 32: Available Measurements for the XGM868**

Channel 1	Units	Channel 2	Units	Average	Units
Ch1 Velocity	ft/s or m/s*	Ch2 Velocity	ft/s or m/s*	Avg Velocity	ft/s or m/s*
Ch1 Act Volumetric	VOL_U	Ch2 Act Volumetric	VOL_U	Avg Act Volumetric	VOL_U
Ch1 Std Volumetric	VOL_U	Ch2 Std Volumetric	VOL_U	Avg Std Volumetric	VOL_U
Ch1 Fwd Totals	TOT_U	Ch2 Fwd Totals	TOT_U	Avg Fwd Totals	TOT_U
Ch1 Rev Totals	TOT_U	Ch2 Rev Totals	TOT_U	Avg Rev Totals	TOT_U
Ch1 #Tot Digits**	none	Ch2 #Tot Digits**	none	Avg #Tot Digits	none
Ch1 Mass Flow	MASS_U	Ch2 Mass Flow	MASS_U	Avg Mass Flow	MASS_U
Ch1 Fwd Mass Totals	MTOT_U	Ch2 Fwd Mass Totals	MTOT_U	Avg Fwd Mass Totals	MTOT_U
Ch1 Rev Mass Totals	MTOT_U	Ch2 Rev Mass Totals	MTOT_U	Avg Rev Mass Totals	MTOT_U
Ch1 #Mass Tot Digits	none	Ch2 #Mass Tot Digits	none	Avg #Mass Tot Digits	none
Ch1 Timer	sec	Ch2 Timer	sec	Avg Timer	sec
Ch1 Error Code	none	Ch2 Error Code	none	Avg Error Code	none
Ch1 SSUP	none	Ch2 SSUP	none	Avg SSUP	none
Ch1 SSDN	none	Ch2 SSDN	none	Avg SSDN	none
Ch1 Sound Speed	ft/s or m/s*	Ch2 Sound Speed	ft/s or m/s*	Avg Sound Speed	ft/s or m/s*
Ch1 Density***	see note	Ch2 Density***	see note		
Ch1 Temperature	Deg F or C*	Ch2 Temperature	Deg F or C*		
Ch1 Pressure	PRESS_U	Ch2 Pressure	PRESS_U		

\*Metric or English units are determined by the setup of the flowmeter.

\*\*Totalizer digits are available for informational purposes only. Respective totals are automatically scaled by the Tot Digits value selected in the flowmeter setup.

\*\*\*If the meter is outputting Mole Weight, the unit is "mw", otherwise it is the programmed pressure unit.

VOL\_U, TOT\_U, MASS\_U, MTOT\_U and PRESS\_U are determined by the units chosen for these measurements in the flowmeter setup. See the instrument User's Manual for the setup of these parameters.

## E.2 Configuration Utility Setup

The following is an *example* setup using National Instruments Configuration Utility v3.1.

Figure 59 shows the Configuration Utility with a flowmeter on the network (Panametrics Flow-XGM).

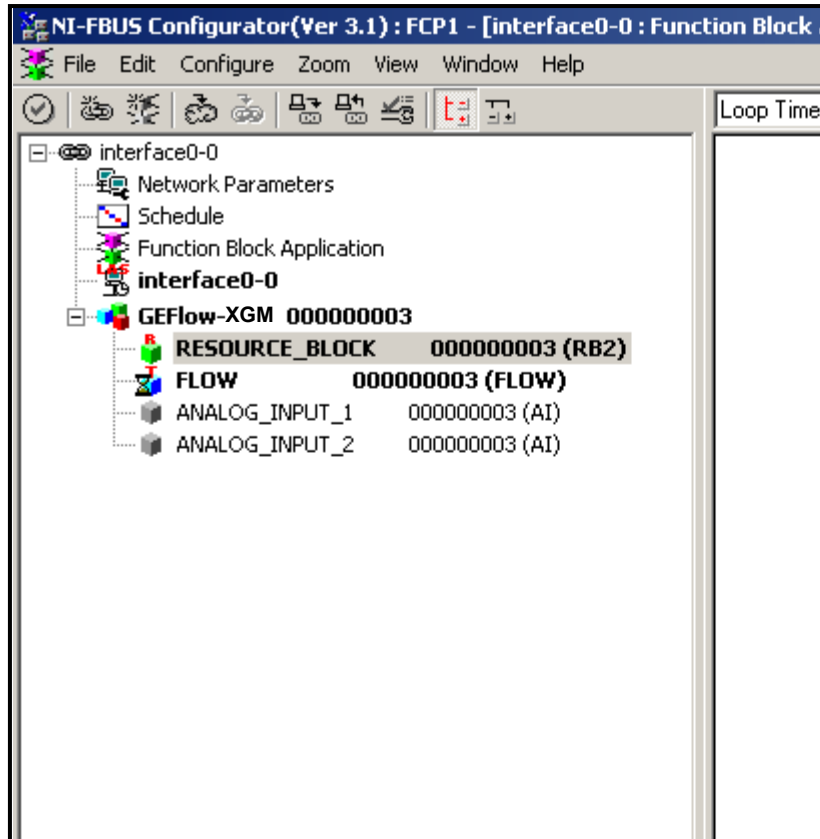

**Figure 59: Configuration Utility Setup Example**

**Note:** The following procedures assume that the device has been placed in the OOS (out-of-service) mode before executing.

## E.3 Selecting the Desired Measurements

To set the measurement unit for each AI:

1. Double click on the FLOW Transducer Block (in the tree under GEFlow-XGM).
2. Select the **Others** tab and open the drop down list for the PRIMARY\_SELECTOR and SECONDARY\_SELECTOR (refer to Figure 60 on page 135).
3. Choose the unit from the list (see Figure 60 on page 135).

This unit will correspond to the unit that is available in the AI block for network connection. The PRIMARY\_SELECTOR unit will correspond to ANALOG\_INPUT\_1 and the SECONDARY\_SELECTOR will correspond to ANALOG\_INPUT\_2.

- After the desired measurements have been selected for the PRIMARY and SECONDARY\_SELECTOR, choose the unit system (UNIT\_SELECTOR above the PRIMARY\_SELECTOR) that was programmed in the flowmeter (English or SI).

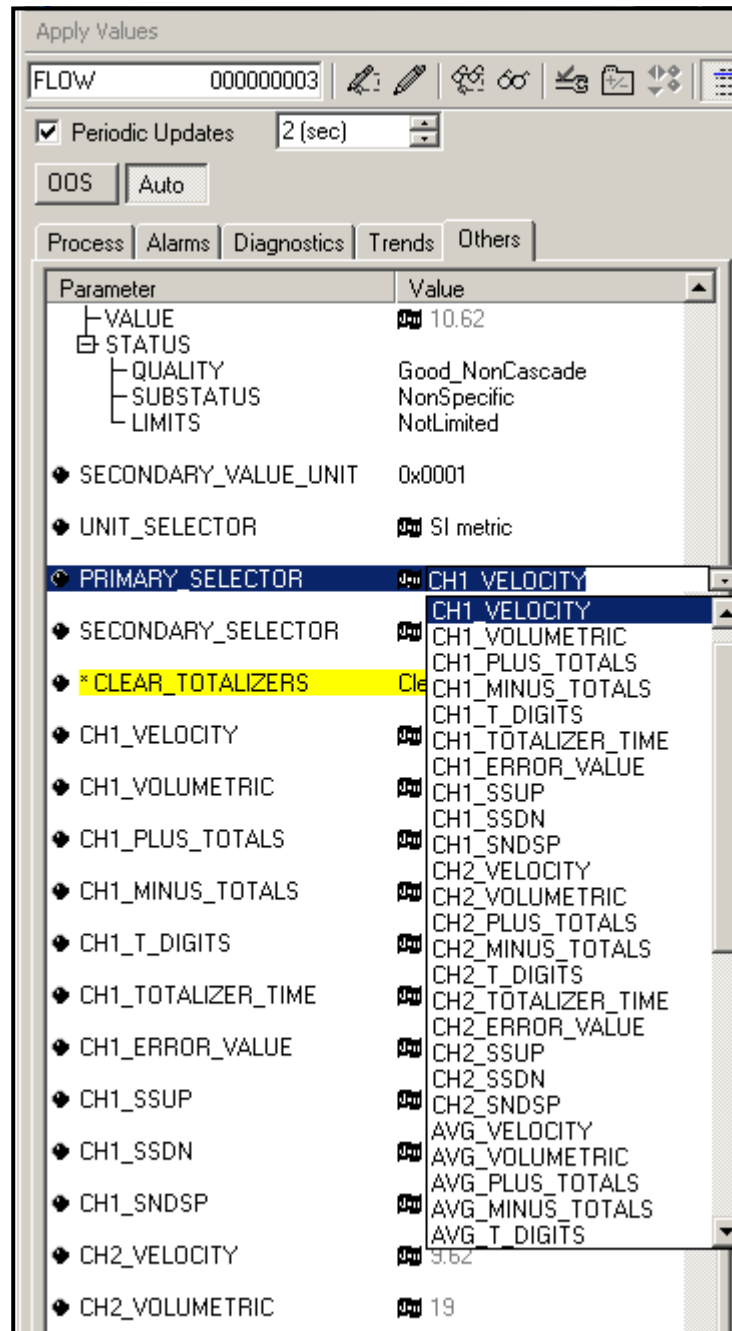

Figure 60: Primary Selector Drop Down List

## E.1 Selecting Units for AI Blocks

To select the units for the individual AI blocks:

1. Double click on the AI block for which you wish to set the units (ANALOG\_INPUT\_1 or ANALOG\_INPUT\_2 in the tree under GEFlow-XGM; see Figure 59 on page 134).
2. Select the **Scaling** tab and set the unit for the measurement based on the flowmeter settings.

For example, if the flowmeter was set to use the metric unit system and the PRIMARY\_SELECTOR was set to use VELOCITY you would choose **m/s** for the unit as shown in Figure 61.

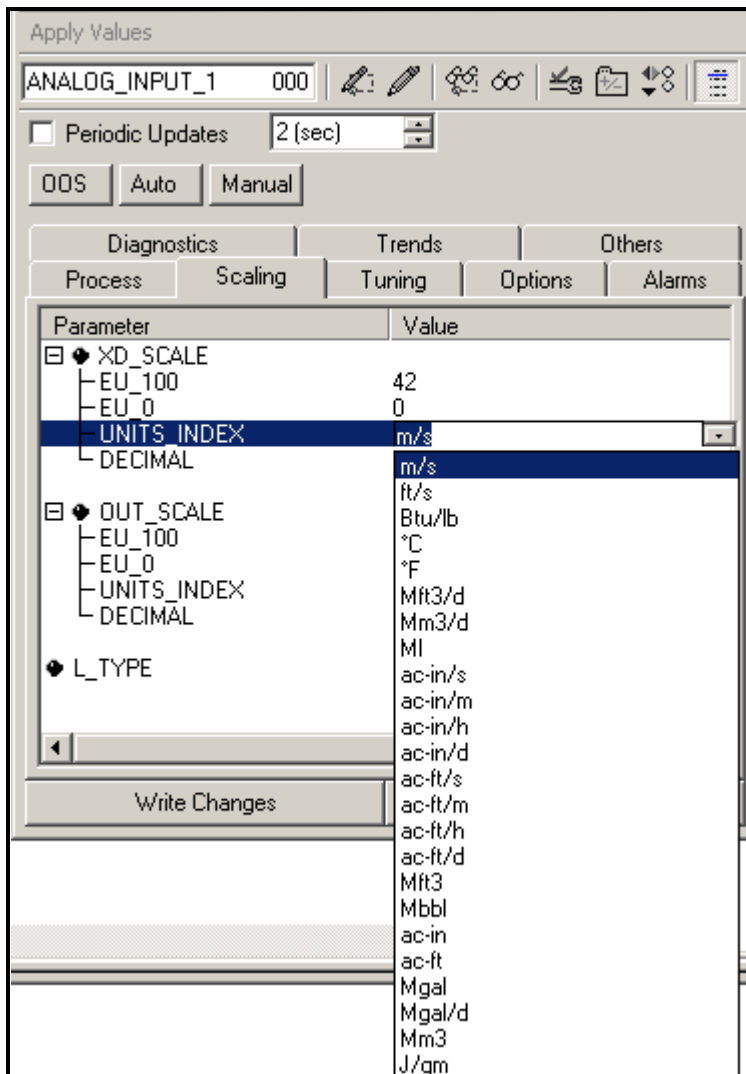

Figure 61: Units Index Drop Down List



## E.1 Resetting Instrument Totalizers

To reset the instrument totalizers:

1. Double click on the FLOW transducer block (in the tree under GEFLOW-XGM; see Figure 59 on page 134).
2. Select the **Others** tab and scroll down to the CLEAR\_TOTALIZERS listing.
3. Select **Clear** from the drop down list box (see Figure 62).
4. After the totals have been reset, select **Normal** from the drop down list box to resume total accumulation.

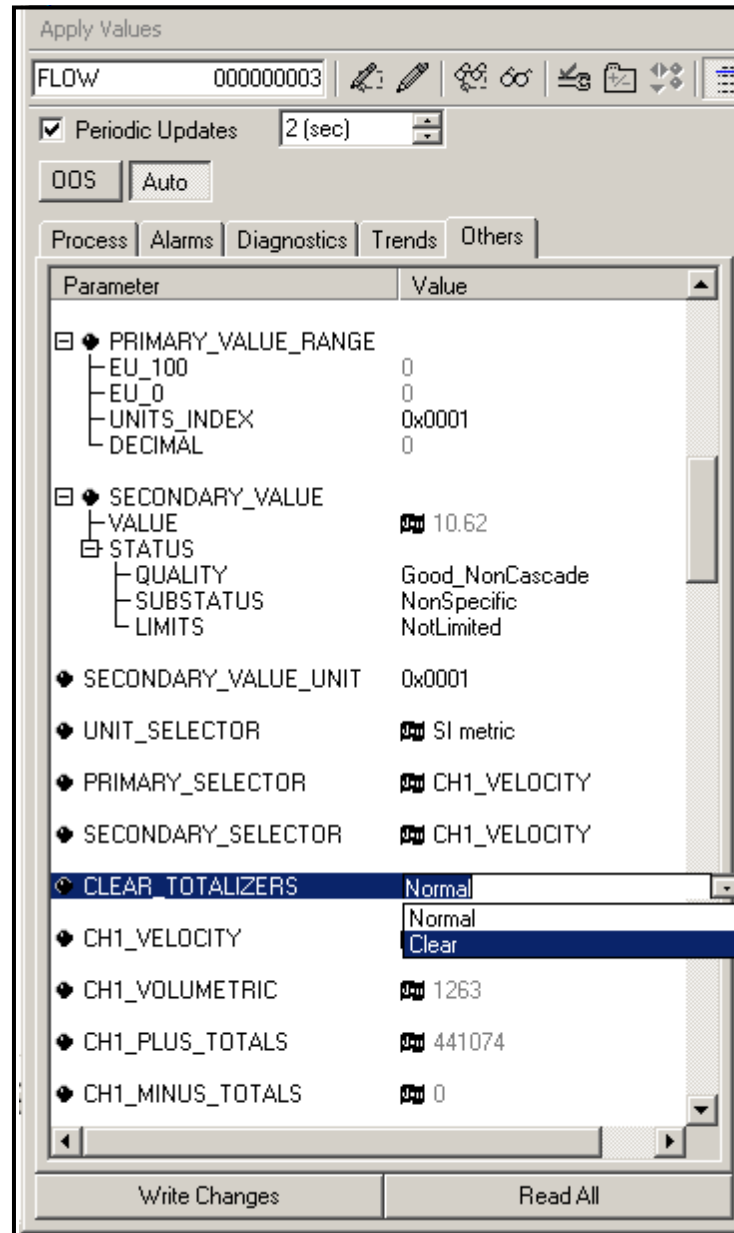

**Figure 62: Clear Totalizers Drop Down List**

## E.1 Function Block Application

Figure 63 is an example setup using the Function Block Application editor. The flowmeter AI blocks, along with the AO and PID of another device on the network, are displayed. We have connected the AI\_1 OUT of the flowmeter to the CAS IN of the AO block. We have also connected the AI\_2 OUT of the flowmeter to the CAS IN of the PID block.

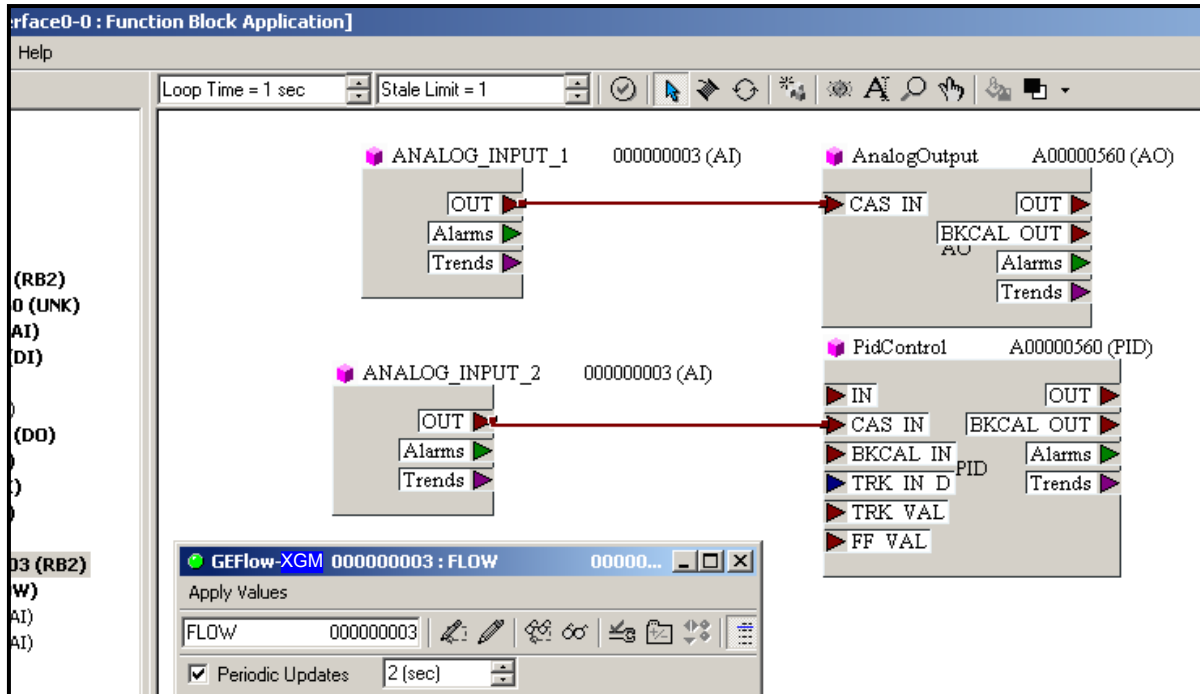

Figure 63: Function Block Application

## Appendix F. Foundation Fieldbus Tables

**Table 33: Panametrics Fieldbus Device Capability, XGX868 Family of Meter Types**

Model		GF868, GS868, GM868, XGF868i, XGM868i, and XGS868i
1.1	Is the Device registered at the Fieldbus Foundation (Yes/No)	Yes
1.2	Is the Unit released to production, and if not, when?	Yes
1.3	Is there any special functionality that device supports (e.g., display blocks, diagnostic blocks)?	No
1.4	Manufacturer Name	Panametrics Measurement & Control
1.5	Model	Panametrics Measurement & Control Gas Flowmeter
1.6	Device Type	0002
1.7	FF Device Revision	02
1.8	Does the device require special programming software to configure a 'good' status on the PV?	Yes
1.9	Does the Device feature a Non-Volatile Memory protection feature? If so, what are the steps to disable/enable from the Resource or Transducer block.	No
1.10	HOST System registered	Yokogawa (TBD), Emerson, Honeywell (TBD), ABB (TBD)
1.11	Design Concept	Entity Concept
1.12	FISCO Compliant?	No
1.13	FNICO Compliant?	Yes: models XGM868i, XGS868i, XGF868i; No: others
1.14	Hazardous Location Certs	GF868, GM868, GS868: CSA for non-incendive Div 2, Class 1, Gr A, B, C, & D. IP66 Optional: Div 1, Class 1, Gr C & D or ATEX II 2 G Ex d IIC T6 IP66 or IECEx II2 G Ex d IIC T6 Gb IP66 XGM868i, XGS868i, XGF868i: CSA Div 1, Class 1, Gr B, C, & D and ATEX II 2 G D Ex d IIC T5 IP66 and IECEx II 2 G Ex d IIC T6 Gb IP66
1.15	FF Liquid PCB p/n: XMT868i / DF868	
1.16	FF Gas PCB p/n: XGX868i / Gx868	703-1475-04 (rev J) / 703-1491-04
1.17	Meter Software version (minimum and higher)	GF868: GF3S; GM868:GM3Q; GS868: GS3N; GC868: GC4C; XGM868i: Y4DM; XGS868: Y4DS; XGF868i:Y4DF
1.18	Firmware on FF card version	868_GAS_FF_206
1.19	Interoperability Test Kit (ITK) revision	6.11
1.2	Protocol	HI
1.21	Protocol Baud (bps)	31.25k

**2 – DD and CFF**

**Table 33: Panametrics Fieldbus Device Capability, XGX868 Family of Meter Types**

2.1	Device Description File Name (.ffo and .sym) and rev	0203
2.2	Capabilities File Name and rev	020101.cff
2.3	Methods (list all methods available)	none
<b>3- Physical</b>		
3.1	Polarity Sensitive (Yes / No)	Yes (Protected from failure if installed incorrectly)
3.2	Quiescent Current Draw (mA)	10 mA idle / 18 mA max
3.3	Startup Current Draw (ma)	18 mA
3.32	Working voltage	9-32 VDC
3.33	Device Minimum Voltage	9 VDC
3.41	Device Resistance (Ohms) fieldbus terminal (+) to (-)	30 Mega Ohms increasing
3.42	Device Resistance (Ohms) fieldbus terminal (+) to Ground	open circuit > 20 MOhm
3.43	Device Resistance (Ohms) fieldbus terminal (-) to Ground	open circuit > 20 MOhm
3.51	Capacitance (microF) (+) to (-)	1 pF
3.52	Capacitance (microF) (+) to Ground	634.7 pF
3.53	Capacitance (microF) (-) to Ground	635.7 pF
3.6	4-wire Device (if so, what AC/DC Voltage, Single or 3-phase)	Yes, (85-250 VAC 50/60 Hz, single phase or 12-28 VDC)
3.7	Connection type	Terminal block, 2-wire twisted pair
<b>4 - Comm</b>		
4.1	Stack Manufacturer	National Instruments
4.2	Does the Device support Backup LAS functionality? (If it does, then the functionality will be tested.)	No
4.3		
4.4	Total Number of VCRs	20
4.5	Number of Fixed VCRs for user configuration (Publisher, Subscriber, Alarming, and Trending)	1 fixed for System Management, 19 variable for user configuration
<b>5 - User Layer General</b>		
5.1	Function Block Application Manufacturer	Fieldbus Inc.
5.2	Function Blocks (list all type, but not including transducer)	6 - AI(e), 1- PID(e), 2 -TB(c), 1- RB2(e)
5.3	Device support block instantiation (Yes/No)	No
5.4	Number of Link Objects	20
5.5	Device support firmware upgrade over fieldbus segment? (Yes/No)	No
5.6	Configuration write protect?	Hardware jumper only
5.7	Zero trim, sensor trim, factory recall/ Upgrade device master reset	None
<b>6 - Resource Block</b>		
6.1	Block Class (Std, Enhanced, Custom)	Enhanced

**Table 33: Panametrics Fieldbus Device Capability, XGX868 Family of Meter Types**

6.2	Special Features	Detailed errors, supported modes, revision id and date
<b>7 – Transducer Blocks</b>		
7.1	Transducer Blocks based on which latest version of the FF spec	FF-902 FS 1.4
7.2	Block Type	Flow/Display
7.3	Block Class (Std, Enhanced, Custom)	Custom/Custom
	Does the Device support Methods in the Resource and Transducer Blocks? (If it does, then the functionality will be tested.)	No
7.4	Special Features besides Methods (multiple VIEWS, etc.)	Multiple View3s and View4s
	Device specific advanced diagnostics	Yes
<b>8 – Function Blocks</b>		
8.1	Does the Device support Custom Function Blocks? An example of custom block has Profile Number equal to or greater than 0x8000. A standard enhanced block has Profile Revision with 0xXXXX, where Enhancement Number upper byte is non-zero (e.g. 0x5500 is en	No
8.2	Block Type	AI/PID
8.3	Number Available	6/1
8.4	Execution Time (ms)	50/100
8.5	Block Class (Std, Enhanced, Custom)	Enhanced
8.6	Function Block Special Features (e.g., Configuration required for non-standard parameters by host)	None
<b>9 – Channels</b>	<b>XD_SCALE and CHANNEL value</b>	<b>List by Channel, Unit Code, Enumerated description, and Function Block Type (if applicable)</b>
9.1	Channel 0	n/a
9.2	Channel 1	Channel 1 - "Primary Value"/"Secondary Value"
		AI Block Units -
		1001 - degree Celsius
		1002 - degree Fahrenheit
		1034 - cubic meter (removed)
		1043 - cubic feet
		1053 - standard cubic foot
		1061 - m/s
		1067 - ft/s
		1088 - kilogram
		1092 - metric ton
		1094 - pound (mass)
		1095 - short ton
		1097 - kilograms per cubic meter
		1107 - pounds per cubic foot

**Table 33: Panametrics Fieldbus Device Capability, XGX868 Family of Meter Types**

		1142 - pounds per square inch absolute
		1143 - pounds per square inch gauge
		1324 - kilogram per hour
		1360 - standard cubic feet per minute
		1361 - standard cubic feet per hour
		1526 - Standard cubic meter (20° 1 atm)
		1547 - kilopascal absolute
		1548 - kilopascal gauge
		1590 - bar gauge (replaced with 34002)
		1597 - Bar absolute (replaced with 34001)
		1653 - cubic Megafeet per day (replaced with 34005)
		33010 - thousands of actual cubic feet (changed to 34028)
		33015 - thousands of actual cubic meters (changed to 34033)
		33022 - thousands of standard cubic feet (changed to 34038)
		33026 - thousands of standard cubic meters (changed to 34043)
		33037 - millions of actual cubic feet (changed to 34004)
		33042 - millions of actual cubic meters (changed to 34009)
		33049 - millions of pounds (changed to 34003)
		33054 - millions of standard cubic feet (changed to 34014)
		33058 - millions of standard cubic meters (changed to 34023)
		33063 - standard cubic feet per day (changed to 34025)
		33064 - standard cubic feet per second (changed to 34026)
		33065 - thousands of pounds (changed to 34027)
		33066 - mole weight (changed to 34024)
		33067 - thousands of kilograms (removed)
		1322 - kilogram per second
		1323 - kilogram per minute
		1325 - kilogram per day
		1326 - metric ton per second
		1327 - metric ton per minute
		1328 - metric ton per hour
		1329 - metric ton per day
		1330 - pound per second
		1331 - pound per minute

**Table 33: Panametrics Fieldbus Device Capability, XGX868 Family of Meter Types**

		1332 - pound per hour
		1333 - pound per day
		1334 - short ton per second
		1335 - short ton per minute
		1336 - short ton per hour
		1337 - short ton per day
		1347 - cubic meter per second
		1348 - cubic meter per minute
		1349 - cubic meter per hour
		1350 - cubic meter per day
		1356 - cubic feet per second
		1357 - cubic feet per minute
		1358 - cubic feet per hour
		1359 - cubic feet per day
		1497 - cubic kilometer per second
		1498 - cubic megameter per second
		1501 - cubic kilometer per minute
		1502 - cubic megameter per minute
		1505 - cubic kilometer per hour
		1506 - cubic megameter per hour
		1509 - cubic kilometer per day
		1510 - cubic megameter per day
		1527 - Standard cubic meter per second (20°, 1atm)
		1528 - Standard cubic meter per minute(20°, 1atm)
		1529 - Standard cubic meter per hour (20°, 1atm)
		1530 - Standard cubic meter per day (20°, 1atm)
		34000 - Actual cubic meters
		34001 - Bar absolute
		34002 - bar gauge
		34003 - million pounds
		34004 - millions of actual cubic feet
		34005 - Millions of actual cubic feet per day
		34006 - Millions of actual cubic feet per hour
		34007 - Millions of actual cubic feet per minute
		34008 - Millions of actual cubic feet per second
		34009 - millions of actual cubic meters
		34010 - Millions of pounds per day
		34011 - Millions of pounds per hour
		34012 - Millions of pounds per minute
		34013 - Millions of pounds per second

**Table 33: Panametrics Fieldbus Device Capability, XGX868 Family of Meter Types**

		34014 - millions of standard cubic feet
		34015 - Millions of Standard cubic feet per day
		34016 - Millions of Standard cubic feet per hour
		34017 - Millions of Standard cubic feet per minute
		34018 - Millions of Standard cubic feet per second
		34019 - Millions of Standard cubic meter per day
		34020 - Millions of Standard cubic meter per hour
		34021 - Millions of Standard cubic meter per minute
		34022 - Millions of Standard cubic meter per second
		34023 - millions of standard cubic meters
		34024 - mole weight
		34025 - Standard cubic feet per day
		34026 - Standard cubic feet per second
		34027 - thousand pounds
		34028 - Thousands of actual cubic feet
		34029 - Thousands of actual cubic feet per day
		34030 - Thousands of actual cubic feet per hour
		34031 - Thousands of actual cubic feet per minute
		34032 - Thousands of actual cubic feet per second
		34033 - Thousands of actual cubic meters
		34034 - Thousands of pounds per day
		34035 - Thousands of pounds per hour
		34036 - Thousands of pounds per minute
		34037 - Thousands of pounds per second
		34038 - Thousands of standard cubic feet
		34039 - Thousands of Standard cubic feet per day
		34040 - Thousands of Standard cubic feet per hour
		34041 - Thousands of Standard cubic feet per minute
		34042 - Thousands of Standard cubic feet per second
		34043 - Thousands of standard cubic meters
		34044 - Thousands of Standard cubic meters per day
		34045 - Thousands of Standard cubic meters per hour



**Table 33: Panametrics Fieldbus Device Capability, XGX868 Family of Meter Types**

		34046 - Thousands of Standard cubic meters per minute
		34047 - Thousands of Standard cubic meters per second
<b>9.3</b>	<b>Channel 2</b>	<b>Channel 2 - "Primary Value"/"Secondary Value"</b>
		AI Block
		Units -
		same as channel 1

[no content intended for this page]

## Symbols

+MASS.....	23		
+TOTL .....	23		
<b>A</b>			
A Divisor .....	13, 98		
Acceleration Limit .....	12, 97		
Act Vol.....	109		
Activating a Channel .....	4		
AcVOL.....	24		
Advanced Features .....	15, 100		
Mass Flow Option.....	101		
Multiple K Factors Option.....	100		
Alarm Relays.....	113		
Alarms			
Option Card.....	27		
Setting Up .....	27		
Alarms Card			
Setting Up in PanaView .....	113		
AMPdn .....	23		
Amplitude Discriminator			
High.....	12, 97		
Low.....	12, 97		
AMPup .....	23		
Analog Inputs			
Option Card.....	25		
RTD Inputs.....	25		
Setting Up .....	25		
Analog Inputs Card			
Setting Up in PanaView .....	111		
Analog Outputs			
Option Card.....	22		
Setting Up .....	22		
Slot 0, Setting Up.....	108		
Arrow Keys .....	3		
Atmospheric Pressure			
Entering in PanaView .....	103		
Axial Length .....	8		
in PanaView.....	93		
<b>B</b>			
Backlight			
See Brightness and Contrast			
Base Pressure, Entering.....	10, 95		
Base Temperature, Entering .....	10, 95		
Basic Programming			
Minimum Requirements.....	86		
Burst Mode .....	13, 97		
<b>C</b>			
Calibration Factor			
in PanaView.....	93		
Channel			
Activating .....	4		
Entering Mass Flow Units .....	6, 19		
Entering Totalizer Units.....	5		
Entering Volumetric Units .....	5		
System Data .....	5		
Channel Menu			
I/O Submenu in PanaView.....	94		
in PanaView.....	89		
Setup Submenu .....	96		
Channel Message			
in PanaView.....	90		
Clearing Totalizers .....	65		
Clearing Transmitter Memory .....	63		
Log File.....	64		
Site Data.....	63		
CNTdn .....	23		
CNTup .....	23		
Communications Port			
Menu.....	31		
Setting Up MODBUS .....	32		
Setting Up with PanaView .....	80		
Submenu.....	117		
Contrast, Adjusting.....	37		
Correlation Peak Limit.....	12, 97		
<b>D</b>			
Data Display on LCD .....	37		
Data, Displaying Using PanaView.....	39, 40		
Default Setup .....	14		
Default Setup Option.....	99		
Default Setup Submenu, Advanced Features.....	100		
DELTA .....	23		
Delta T .....	109		
Delta T M.....	110		
Delta T Offset .....	12, 97		
Delta T S .....	109		
Diagnostics			
A Divisor .....	13, 98		
Acceleration Limit .....	12, 97		
Amplitude Discriminator High .....	12, 97		
Amplitude Discriminator Low .....	12, 97		
Correlation Peak Limit .....	12, 97		
Delta T Offset .....	12, 97		
M>S Switch .....	13, 97		
Number of Shifts.....	13, 98		
Number of Transmit Pulses.....	13, 98		
Percent of Peak .....	12, 97		
R Window.....	13, 98		
Signal Low Limit.....	12, 97		
Skan T Offset .....	12, 97		
Soundspeed Limit .....	12, 97		
T Window .....	13, 98		
Velocity High Limit.....	12, 97		
Velocity Low Limit .....	12, 97		
Displaying Data .....	37		
Displaying Text .....	40		
DN ← Peak.....	109		
DN Amp Discrim .....	109		
DN DAC COUNTS .....	109		
DN Sig Strength.....	109		
DN Signal Q.....	109		
DN Transit .....	109		
Dn Transit M.....	110		
Dn Transit S .....	109		

Down Arrow Key ..... 3

DT M ..... 24

DT S ..... 24

**E**

Edit Menu ..... 80

Enter Key ..... 3

Entering Numeric Values ..... 3

Entering System Data in PanaView ..... 90

Error Handling ..... 106

    2-Path ..... 21, 107

    Selecting for One-Channel ..... 20

    Selecting for Two-Channel ..... 20

Error Response Options in PanaView ..... 106

Escape Key ..... 3

Ethernet, Setting up with PanaView ..... 81

**F**

Fluid Type

    Entering ..... 8

    in PanaView ..... 93

Foundation Fieldbus ..... 31, 133

Frequency Card, Setting Up ..... 115

Frequency Outputs

    Option Card ..... 30

    Setting Up ..... 30

Frequency, in PanaView ..... 92

FWD Mass ..... 109

FWD Total ..... 109

**G**

Global

    Entering Mass Flow Units ..... 19

    Entering System Data ..... 18

    Entering Totalizer Units ..... 19, 104

    Entering Volumetric Units ..... 18

    Menu ..... 17

Global Menu

    Comm Port Submenu ..... 117

    I/O Submenu ..... 37, 105

    in PanaView ..... 102

    LCD Option ..... 37, 116

    Options Option ..... 108

    System Submenu ..... 103, 121

Global System Submenu ..... 103, 121

Global-I/O-Error ..... 106

Graph Window ..... 43

Graphing Data ..... 43

**I**

I/O Submenu

    Error Option ..... 106

    in PanaView ..... 94

    Options Option ..... 108

    Zero Cutoff Value, Entering ..... 94

Initial Setup

    Data Table ..... 75

Initialing Setup ..... 14

Input/Output (Channel)

    Low Pressure Switch ..... 11, 95

    Pressure Input ..... 10, 95

    Temperature ..... 9, 94

    Zero Cutoff Value ..... 9

Input/Output (Global)

    Error Handling ..... 20

    Setting Up ..... 20

Inputs and Outputs

    Setting up in PanaView ..... 105

**K**

K Factors, Entering ..... 15

K(Re)\*Multi K\*K Factor ..... 109

Keypad Program, Entering ..... 3

Keypad Program, Exiting if Unused ..... 4

KV Input Selection ..... 8

**L**

LCD

    Contrast, Adjusting ..... 37

    Option ..... 37, 116

    Programming ..... 37

    See Liquid Crystal Display

Left Arrow Key ..... 3

Liquid Crystal Display (Transmitter) ..... 37

    Setting Up ..... 37

    Setting Up in PanaView ..... 116

Log File, Clearing ..... 64

Logs

    Creating, Meter ..... 49

    Creating, PC ..... 54

    Deleting ..... 60

    Graphing ..... 57, 60

    Naming ..... 56

    Status ..... 59

    Type ..... 49

    Viewing ..... 59

    Window ..... 56

Low Pressure Switch, Entering ..... 11, 95

**M**

M>S Switch ..... 13, 97

Magnetic Keypad, Using ..... 2

-MASS ..... 23

Mass Flow ..... 109

    Activating ..... 16

    Activating in PanaView ..... 101

    Data in Global Menu (PanaView) ..... 105

    Entering Channel Units ..... 6, 19

    Entering Data in PanaView ..... 91

    Entering Global Units ..... 19

MDOT ..... 23

Measurement Method

    Selecting ..... 89

Memory

    Clearing Log File ..... 64

    Clearing Site Data ..... 63

    Clearing Transmitter ..... 63

Menus

    Edit ..... 80

    Output ..... 39

Meter Logs, Creating .....	49		
MODBUS Communications			
Requesting Parameters .....	33		
Setting Up .....	32		
Setting up with PanaView .....	117		
MODBUS Registers .....	118		
Multiple K Factors			
Entering .....	15		
in PanaView .....	100		
Multiple Parameter Text Displays .....	42		
Multiple Text Windows .....	42		
		<b>N</b>	
Number of Pulses .....	13, 98		
Number of Shifts .....	13, 98		
		<b>O</b>	
Option Card Setup			
Alarm Relays .....	27		
Analog Inputs .....	25		
Analog Outputs .....	22		
Frequency Outputs .....	30		
MODBUS .....	32		
RTD Inputs .....	26		
Totalizer Outputs .....	28		
Option Cards			
Alarms .....	113		
Analog Inputs .....	111		
Frequency .....	115		
Programming in PanaView .....	108		
RTD Inputs .....	112		
Setup Information Table .....	74		
Totalizer .....	114		
Totalizer/Frequency .....	115		
Types Available .....	73		
Output Menu .....	39		
		<b>P</b>	
P#dn .....	23		
P#up .....	23		
PanaView .....	39, 40		
Capabilities .....	2		
Communication Setup .....	117		
Entering Menu .....	87		
Parameter, Selecting .....	41, 44		
Path Length .....	7		
PC Logs, Creating .....	54		
PEAK% .....	23, 109		
Percent of Peak .....	12, 97		
PIPE			
in PanaView .....	92		
Pipe Length .....	7		
in PanaView .....	93		
Pipe OD Unit .....	7		
in PanaView .....	93		
Pipe OD, Programming .....	7, 93		
Pipe Parameters			
Axial Length .....	8		
Entering .....	6		
Entering, in PanaView .....	92		
OD/Circumference .....	7		
Path Length .....	7		
Special Transducers .....	6		
Wall Thickness .....	7, 93		
Plotting Signal .....	46		
PRESR .....	23		
Pressure .....	109		
Input, Entering .....	95		
Units, Selecting in PanaView .....	103		
Pressure Input, Entering .....	10		
Printing Data .....	61		
PROG Menu, in Keypad Program .....	35		
Properties Option			
in Edit Menu (PanaView) .....	123		
		<b>Q</b>	
Qdown .....	23		
Qup .....	23		
		<b>R</b>	
R Window (cycles) .....	13, 98		
Response Time .....	14, 99		
Return Policy .....	153		
REV Mass .....	109		
REV Total .....	109		
Reynolds Correction in PanaView .....	93		
Right Arrow Key .....	3		
RTD Inputs			
Setting Up .....	26		
Setting Up in PanaView .....	112		
		<b>S</b>	
Serial Communications .....	31, 117		
Serial Port			
Setting up in PanaView .....	117		
Setup Data			
Advanced Features .....	15		
Initializing/Default .....	14		
Response Time-V Averaging .....	14		
Transducer Signal Parameters .....	11		
Setup Submenu			
Advanced Features Option .....	100, 101		
Default Setup Option .....	99		
Mass Flow Option .....	101		
Signal Option .....	96		
V Averaging Option .....	99		
Setup Submenu in PanaView .....	96		
Signal			
Graph .....	46		
Low Limit .....	12, 96, 97		
Option in PanaView .....	96		
Plot .....	46		
Reading in PanaView .....	46		
Save .....	47		
Transducer .....	11		
Transit-Time Values .....	96		
Type .....	46		

Site Data	
Clearing	63, 126
Printing to PC	126
Saving in PanaView	123
Saving to Meter	124
Saving to PC	125
Saving to XGM868i	125
Site Edit Menu	
Global Menu	102
Site File Operations	124
Skam Only	4
in PanaView	89
Skam T Offset	12, 97
Skam/Measure	4
in PanaView	89
Slot 0	
Analog Outputs	22
Setting Up	108
Slot Number	20, 105
SNDSP	23
Soundspeed	109
Special Transducers, Entering Number	6
SS do	23
SS up	23
Startup (See Basic Programming)	86
Static Density	
Activating in PanaView	101
Entering	16
Status of Logs	59
Status Submenu	89
Std Vol.	109
StVOL	24
System (Global) Submenu	103, 121
System Data	
Channel, Entering	5
Global, Entering	18
Mass Flow Units, Entering Channel	6, 19
Mass Flow Units, Entering Global	19
Totalizer Units, Entering Channel	5
Totalizer Units, Entering Global	19, 104
Volumetric Units, Entering Channel	5
Volumetric Units, Entering Global	18
System Units, Global Menu (PanaView)	103
<b>T</b>	
T Window (cycles)	13, 98
Td M	24
Td S	24
Tdown	23
TEMP	23
Temperature	109
Temperature Input, Entering	9, 94
Text Window	40
Time	109
Time Delay (Tw), in PanaView	92
TIMER	23
Tot K	23
Totalizer Card, Setting Up in PanaView	114
Totalizer Outputs	
Entering Channel Units	5
Entering Global Units	19, 104
Setting Up	28
Totalizer Units, in PanaView	90
Totalizer/Frequency Card, Setting Up	115
Totalizers, Clearing	65
-TOTL	23
Tracking Windows, Activating	8
Transducer Number	6
Transducer Number, in PanaView	92
Transducer Parameters, Entering in PanaView	92
Transducer Parameters, Programming	6
Transducer Signals	
Displaying in PanaView	45
Plotting in PanaView	46
Saving in PanaView	47
Settings	11
Transducers, Special, Entering Number	6
Transit-Time Values	96
Transmitter	
Clearing Menu	63
Displaying Data	37
LCD, Setting Up	37
LCD, Setting Up in PanaView	116
Tu M	24
Tu S	24
Tup	23
Two-Path Error Handling	20
<b>U</b>	
UP +-Peak	109
UP Amp Discrim	109
UP Arrow Key	3
UP DAC COUNTS	109
UP Sig Strength	109
UP Signal Q	109
UP Transit	109
Up Transit M	109
Up Transit S	109
User Program	
Global Menu	102, 103, 106, 108
System Submenu <sup>121</sup>	
I/O Submenu	105, 117
LCD Option	37, 116
Minimum Requirements	86
Status Submenu	89
<b>V</b>	
V Averaging Option in PanaView	99
V Averaging, Setting	14
VEL	23
Velocity	109
Velocity High Limit	12, 97
Velocity Low Limit	12, 97
Viewing Logs	59

---

Vinst .....	24, 110
VOLUM .....	23
Volumetric .....	109
Volumetric Units	
Channel, Entering .....	5
Global, Entering .....	18
in Global Menu (PanaView) .....	104
in PanaView .....	90
	<b>W</b>
Warranty .....	153
Windows	
Resizing .....	42
Tiling .....	42
	<b>X</b>
XGM868i, Adding onto PanaView .....	84
	<b>Z</b>
Zero Cutoff Value, Entering .....	9
in PanaView .....	94





---

## Warranty

Each instrument manufactured by Panametrics is warranted to be free from defects in material and workmanship. Liability under this warranty is limited to restoring the instrument to normal operation or replacing the instrument, at the sole discretion of Panametrics. Fuses and batteries are specifically excluded from any liability. This warranty is effective from the date of delivery to the original purchaser. If Panametrics determines that the equipment was defective, the warranty period is:

- one year from delivery for electronic or mechanical failures
- one year from delivery for sensor shelf life

If Panametrics determines that the equipment was damaged by misuse, improper installation, the use of unauthorized replacement parts, or operating conditions outside the guidelines specified by Panametrics, the repairs are not covered under this warranty.

---

**The warranties set forth herein are exclusive and are in lieu of all other warranties whether statutory, express or implied (including warranties or merchantability and fitness for a particular purpose, and warranties arising from course of dealing or usage or trade).**

---

## Return Policy

If a Panametrics instrument malfunctions within the warranty period, the following procedure must be completed:

- 1.** Notify Panametrics, giving full details of the problem, and provide the model number and serial number of the instrument. If the nature of the problem indicates the need for factory service, Panametrics will issue a RETURN AUTHORIZATION NUMBER (RAN), and shipping instructions for the return of the instrument to a service center will be provided.
- 2.** If Panametrics instructs you to send your instrument to a service center, it must be shipped prepaid to the authorized repair station indicated in the shipping instructions.
- 3.** Upon receipt, Panametrics will evaluate the instrument to determine the cause of the malfunction. Then, one of the following courses of action will then be taken:
  - If the damage is covered under the terms of the warranty, the instrument will be repaired at no cost to the owner and returned.
  - If Panametrics determines that the damage is not covered under the terms of the warranty, or if the warranty has expired, an estimate for the cost of the repairs at standard rates will be provided. Upon receipt of the owner's approval to proceed, the instrument will be repaired and returned.

[no content intended for this page]



## Customer Support Centers

### U.S.A.

The Boston Center  
1100 Technology Park Drive  
Billerica, MA 01821  
U.S.A.  
Tel: 800 833 9438 (toll-free)  
978 437 1000  
E-mail: [mstechsupport@bakerhughes.com](mailto:mstechsupport@bakerhughes.com)

### Ireland

House  
Shannon Free Zone East  
Shannon, County Clare  
Ireland  
Tel: +353 (0)61 470200  
E-mail: [mstechsupport@bakerhughes.com](mailto:mstechsupport@bakerhughes.com)

Copyright 2021 Baker Hughes company.

This material contains one or more registered trademarks of Baker Hughes Company and its subsidiaries in one or more countries. All third-party product and company names are trademarks of their respective holders.

BH061C31 EN F (07/2021)

**Baker Hughes** 