



PanaFlow™ HT

User's manual

910-294U Rev. A

PanaFlow™ HT

Ultrasonic liquid flowmeter

User's manual

910-294U Rev. A
September 2012



[no content intended for this page]

Contents

Chapter 1. Introduction

1.1 Overview	1
1.2 Theory of operation	2
1.2.1 Transit-time flow measurement	2
1.2.2 Active temperature compensation	3
1.3 SIL Application	3

Chapter 2. Installation

2.1 Introduction	5
2.2 Unpacking	6
2.2.1 Identification	6
2.2.2 Transport	7
2.3 Site considerations	7
2.3.1 Meter body location	7
2.3.2 Electronics enclosure location (remote mount)	9
2.3.3 Cable lengths	9
2.3.4 Transducer cables	9
2.4 Mounting the electronics	10
2.5 Making electrical connections	11
2.5.1 Preparing for wiring	12
2.5.2 Wiring analog outputs	13
2.5.3 Wiring digital outputs	14
2.5.4 Wiring the modbus/service port	19
2.5.5 Wiring the calibration port	20
2.5.6 Wiring the line power	21
2.6 Wiring transducers (remote mount cable)	22
2.6.1 Remote mount wiring instructions	23

Chapter 3. Initial setup and programming

3.1 Introduction	25
3.2 User restrictions	25
3.3 PanaFlow HT enclosure magnetic keypad	27
3.4 Display programming	29
3.4.1 Changing value for one or two-variable screens	29
3.4.2 Changing measurement type for one- or two-variable screens	29
3.4.3 Changing the measurement type or value for totalizer screens	33
3.4.4 Starting or stopping totalizer measurement	35
3.4.5 Resetting the totalizer	35
3.5 Entering the main menu	36
3.5.1 Display format	37
3.5.2 Keypad lockout	37
3.5.3 Program/program review	38
3.5.4 Program review	38
3.5.5 Program mode	39

3.6 User preferences	40
3.6.1 Settings	41
3.6.2 Flow units	43
3.6.3 Meter setup	47
3.6.4 Password	49
3.6.5 Display	50
3.7 Input/output setup	51
3.7.1 Analog output A (SIL)	51
3.7.2 Analog output B (Non-SIL)	56
3.7.3 Programming the digital outputs	60
3.7.4 Modbus/service port A	72
3.8 SIL testing	74
3.8.1 Accessing the SIL testing menu	74
3.8.2 Testing the min/max output	75
3.8.3 Testing the output analog switch	76
3.8.4 Viewing the on board temperature	76
3.8.5 Performing a watchdog test	76

Chapter 4. Error codes and troubleshooting

4.1 User restrictions	77
4.2 Error display in the user interface	77
4.2.1 Error header	77
4.2.2 Communication error string	78
4.2.3 Flow error string	78
4.2.4 SIL error string	80
4.3 Diagnostics	81
4.3.1 Introduction	81
4.3.2 Flowcell problems	81
4.3.3 Transducer/buffer problems	83

Appendix A. Specifications

A.1 Operation and performance	85
A.2 Meter body/transducer	86
A.3 Electronics	87

Appendix B. Menu maps

Appendix C. Modbus map

C.1 Frequently used modbus addresses	97
C.2 User group definitions	98
C.3 Modbus map	99
C.4 Modbus unit codes	124
C.5 Modbus protocol	127

Appendix D. HART menu maps

D.1 HART connection	129
D.1.1 Wiring to the HART circuit	129

D.1.2 Write mode switch	129
D.1.3 Use force high with HART	130
D.2 Root menu	130
D.3 HART service map for general users	131
D.4 HART service menu for SIL users	132
D.5 Review menu	133
Appendix E. Special applications	
E.1 Pig detection	135
E.2 Path error handling	136
Appendix F. Data records	
F.1 Service record	139
F.2 Initial settings	141
F.3 Diagnostic parameters	143
Appendix G. CE Mark compliance	
G.1 Introduction	145
G.2 Wiring	145

[no content intended for this page]

Product registration

Thank you for purchasing a model PanaFlow™ HT from Panametrics. Please register your product at <https://info.bakerhughesds.com/New-product-registration-LP.html> product support such as the latest software/firmware upgrades, product information and special promotions.

Services

Panametrics provides customers with an experienced staff of customer support personnel ready to respond to technical inquiries, as well as other remote and on-site support needs. To complement our broad portfolio of industry-leading solutions, we offer several types of flexible and scalable support services including: training, Product repairs, service Agreements and more. Please visit change to: <https://www.bakerhughesds.com/panametrics/services> for more details.

Terms and conditions

Panametrics' sales terms and conditions for your recent purchase of a Panametrics product, including the applicable product warranty, can be found on our website at the following link: <https://www.bakerhughesds.com/sales-terms-conditions>.

Information paragraphs

Note: These paragraphs provide information that provides a deeper understanding of the situation, but is not essential to the proper completion of the instructions.

IMPORTANT:

These paragraphs provide information that emphasizes instructions that are essential to proper setup of the equipment. Failure to follow these instructions carefully may cause unreliable performance.



CAUTION!

This symbol indicates a risk of potential minor personal injury and/or severe damage to the equipment, unless these instructions are followed carefully.



WARNING!

This symbol indicates a risk of potential serious personal injury, unless these instructions are followed carefully.

Safety issues



WARNING!



It is the responsibility of the user to make sure all local, county, state and national codes, regulations, rules and laws related to safety and safe operating conditions are met for each installation.

Auxiliary equipment

Local safety standards

The user must make sure that he operates all auxiliary equipment in accordance with local codes, standards, regulations, or laws applicable to safety.

Working area

	<p>WARNING!</p> <p>Auxiliary equipment may have both manual and automatic modes of operation. As equipment can move suddenly and without warning, do not enter the work cell of this equipment during automatic operation, and do not enter the work envelope of this equipment during manual operation. If you do, serious injury can result.</p>
	<p>WARNING!</p> <p>Make sure that power to the auxiliary equipment is turned OFF and locked out before you perform maintenance procedures on this equipment.</p>

Qualification of personnel

Make sure that all personnel have manufacturer-approved training applicable to the auxiliary equipment.

Personal safety equipment

Make sure that operators and maintenance personnel have all safety equipment applicable to the auxiliary equipment. Examples include safety glasses, protective headgear, safety shoes, etc.

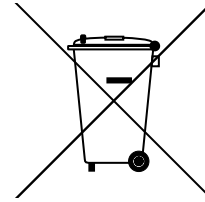
Unauthorized operation

Make sure that unauthorized personnel cannot gain access to the operation of the equipment.

Environmental compliance

Waste Electrical and Electronic Equipment (WEEE) directive

Panametrics is an active participant in Europe's Waste Electrical and Electronic Equipment (WEEE) take-back initiative (Directive 2012/19/EU).



The equipment that you bought has required the extraction and use of natural resources for its production. It may contain hazardous substances that could impact health and the environment.

In order to avoid the dissemination of those substances in our environment and to diminish the pressure on the natural resources, we encourage you to use the appropriate take-back systems. Those systems will reuse or recycle most of the materials of your end life equipment in a sound way.

The crossed-out wheeled bin symbol invites you to use those systems.

If you need more information on the collection, reuse and recycling systems, please contact your local or regional waste administration.

Please visit <https://www.bakerhughesds.com/health-safetyand-environment-hse> for take-back instructions and more information about this initiative.

Chapter 1. Introduction

1.1 Overview

Thank you for purchasing the PanaFlow HT ultrasonic flowmeter. PanaFlow HT is a wetted ultrasonic flow meter that is SIL certified (IEC61508 pending) by design to give you confidence in your flow measurement and to provide reliable flow meter operation for both safety and process control systems. In addition to the peace of mind that SIL certification brings, PanaFlow HT also has all the advantages of ultrasonic flow measurement over other traditional technologies—no measurement drifting, no periodic

calibration requirement, no restriction in the pipe, minimal pressure drop, no maintenance, and no moving parts.

The PanaFlow HT consists of the new XMT900 electronics, the field proven BWT transducers system, FTPA buffers and a meter body. It is available in both a local or remote mount configuration based on convenience and process temperature requirements.

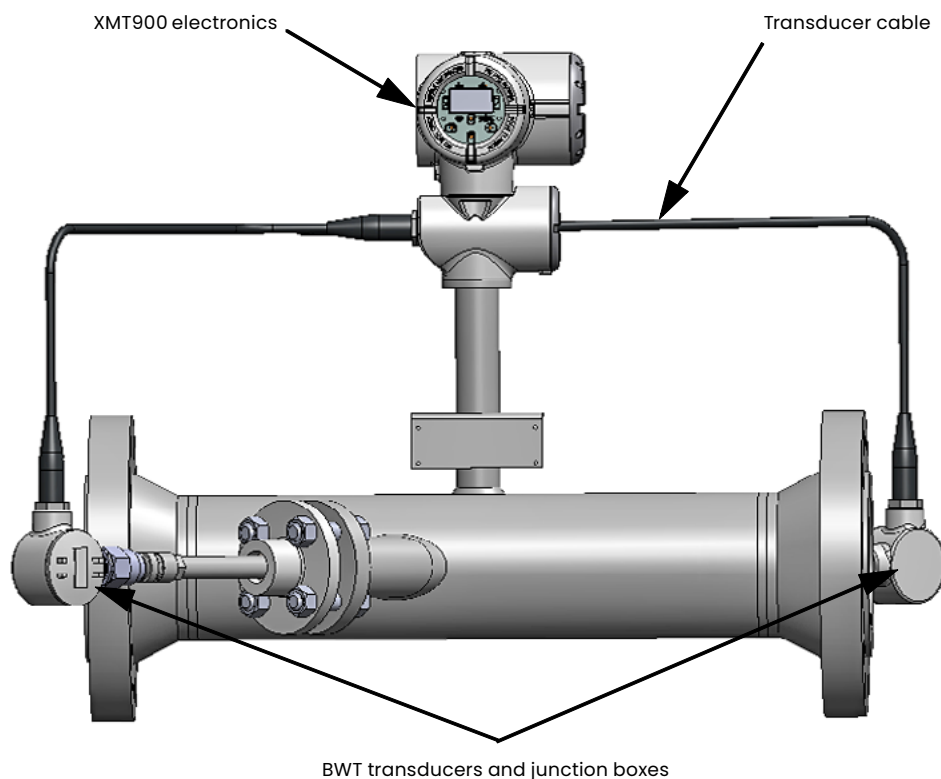


Figure 1: PanaFlow HT (local mount)

1.2 Theory of operation

1.2.1 Transit-time flow measurement

In this method, two transducers serve as both ultrasonic signal generators and receivers. They are in acoustic communication with each other, meaning the second transducer can receive ultrasonic signals transmitted by the first transducer and vice versa.

In operation, each transducer functions as a transmitter, generating a certain number of acoustic pulses, and then as a receiver for an identical number of pulses. The

time interval between transmission and reception of the ultrasonic signals is measured in both directions. When the liquid in the pipe is not flowing, the transit-time downstream equals the transit-time upstream. When the liquid is flowing, the transit-time downstream is less than the transit-time upstream.

The difference between the downstream and upstream transit times is proportional to the velocity of the flowing liquid, and its sign indicates the direction of flow.

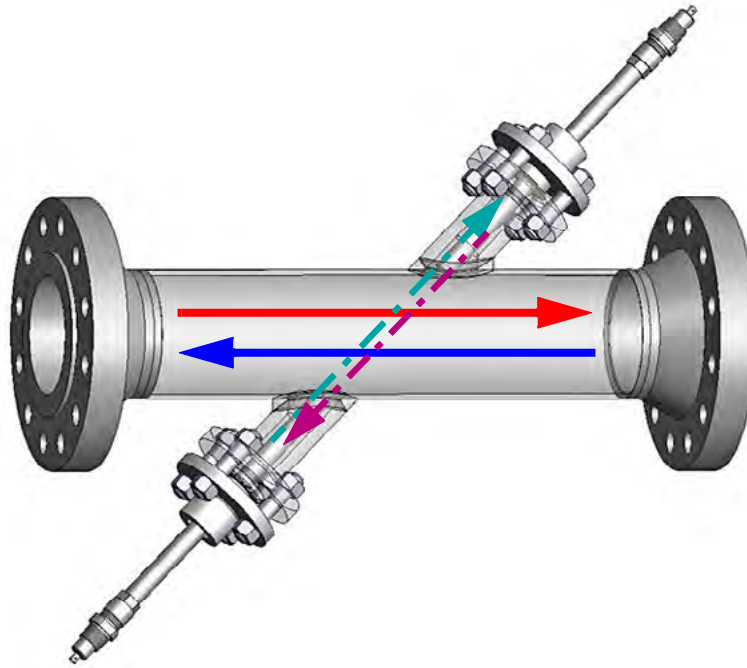


Figure 2: Flow and transducer paths

1.2.2 Active temperature compensation

Ultrasonic flowmeters use transit time to determine the liquid or gas flow in a pipeline.

Measured transit time consists not only of the time the ultrasonic signal spends in a fluid, but also of a portion of “dead time,” being the time that the electrical signal is converted into an acoustical signal and the time the acoustic signal travels inside the transducer.

To allow for the utmost accuracy, PanaFlow HT uses pulse echo to actively measure the dead time. By sending a pulse and measuring its reflection, the dead time is measured in real time rather than using a preset value. As a result of this Panametrics invention, PanaFlow HT maintains its accuracy as process temperature conditions dynamically change.

1.3 SIL application

PanaFlow HT is a SIL2 ultrasonic flowmeter (sensor) with the capability of providing a SIL3 system in a redundant design configuration. PanaFlow HT is IEC61508 certified through a complete design validation from a third party organization. By achieving a third party certification, we have proven the required design rigor through the product safety lifecycle, and the implementation of functional safety management. This added design, manufacturing, and control rigor ensures that the Panametrics PanaFlow HT is the optimal ultrasonic flowmeter for your safety or process control system.

[no content intended for this page]

Chapter 2. Installation

2.1 Introduction

To ensure safe and reliable operation of the PanaFlow HT, the system must be installed in accordance with the established guidelines. Those guidelines, explained in detail in this chapter, include the following topics:

- Unpacking the PanaFlow HT system
- Selecting suitable sites for the electronics enclosure and the meter body
- Installing the meter body
- Installing the electronics enclosure (remote mount option)
- Wiring the electronics enclosure



WARNING!

The PanaFlow HT flow transmitter can measure the flow rate of many fluids, some of which are potentially hazardous. The importance of proper safety practices cannot be overemphasized.

Be sure to follow all applicable local safety codes and regulations for installing electrical equipment and working with hazardous fluids or flow conditions. Consult company safety personnel or local safety authorities to verify the safety of any procedure or practice.



Attention European customers!

To meet CE Mark requirements, all cables must be installed as described in Appendix G, CE Mark Compliance.

2.2 Unpacking

Before removing the PanaFlow HT system from the crate, please inspect the flowmeter. Each instrument manufactured by Panametrics Measurement & Control is warranted to be free from defects in material and workmanship. Before discarding any of the packing materials, account for all components and documentation listed on the packing slip. The discarding of an important item along with the packing materials is all too common. If anything is missing or damaged, contact Panametrics Customer Care immediately for assistance.

Please note that your PanaFlow HT system may come in one of the three common configurations as shown below or a custom design system. Also, the electronics may be in a separate box from the meter body for a remote mount configuration.

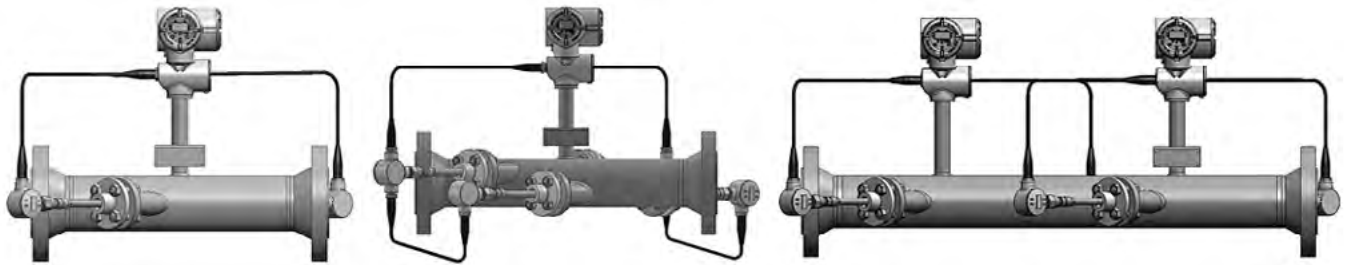


Figure 3: PanaFlow HT Configurations

2.2.1 Identification

The PanaFlow HT meter has up to three separate labels for identification, depending on configuration. The system can be either mounted as a single unit (local mounting) or as two separate pieces (remote mounting).

2.2.1a XMT900 transmitter identification

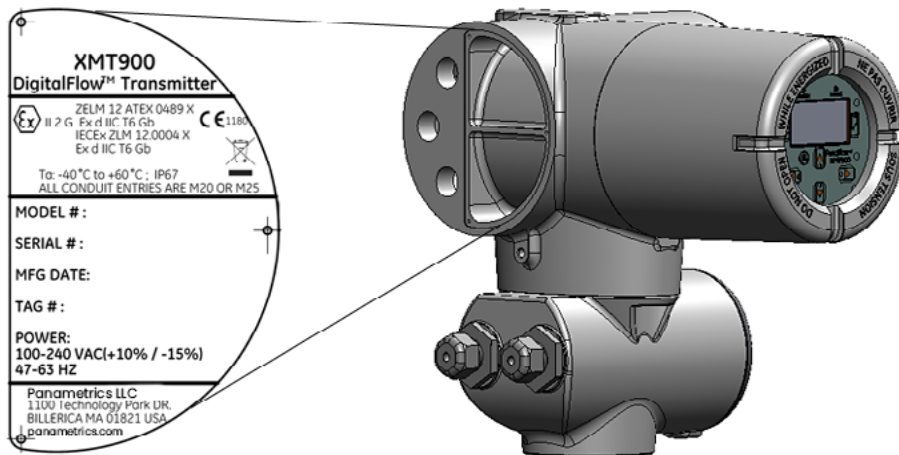


Figure 4: XMT Transmitter Label (example)

2.2.1b Meter body identification

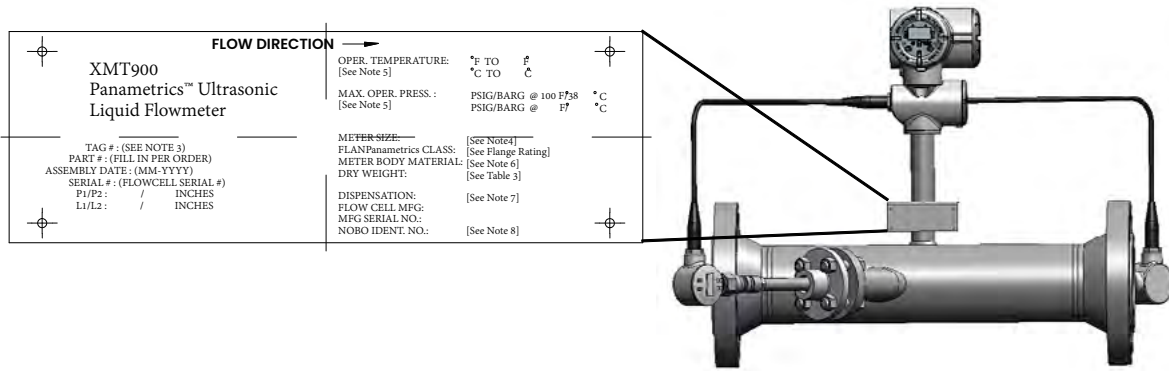


Figure 5: Flowcell Identification (example)

2.2.2 Transport

Figure 6 below indicates the proper way to cinch the lifting straps to the flowmeter. This is the only approved way to hoist the flowmeter into position in the pipeline.

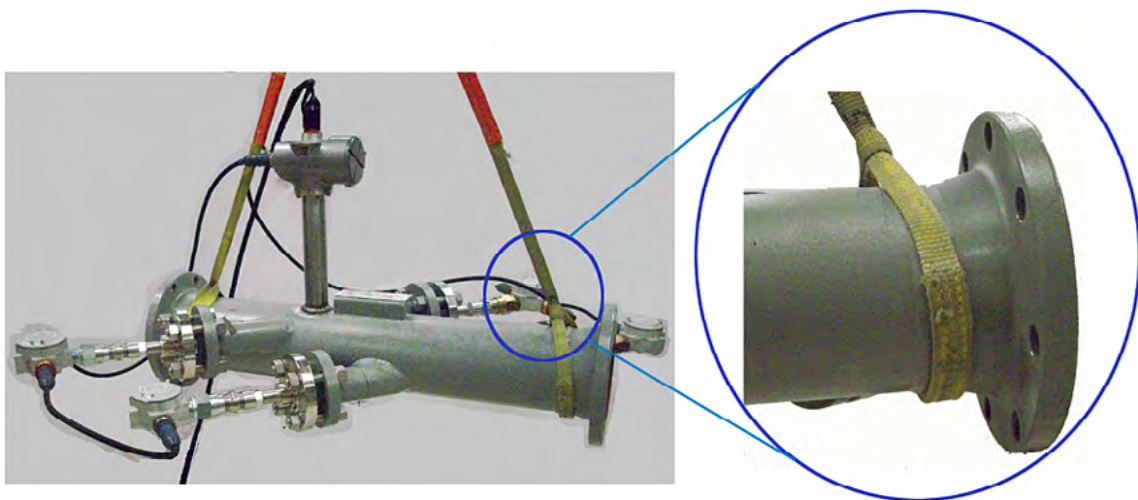


Figure 6: Hoisting PanaFlow HT

2.3 Site considerations

Because the relative location of the meter body and the electronics enclosure is important, use the guidelines in this section to plan the PanaFlow HT installation.

2.3.1 Meter body location

Ideally, choose a section of pipe with unlimited access; for example, a long stretch of pipe that is above ground. However, if the meter body is to be mounted on an underground pipe, dig a pit around the pipe to facilitate installation or removal of the transducers.

IMPORTANT:

The FTPA buffer bolts on the meter body are factory set and should not be tightened.

2.3.1a Transducer location

For a given fluid and pipe, the PanaFlow HT's accuracy depends on the location and alignment of the transducers. In addition to accessibility, when planning for transducer location, adhere to the following guidelines:

- Locate the meter body so that there are at least 10 pipe diameters of straight, undisturbed flow upstream and 5 pipe diameters of straight, undisturbed flow downstream from the measurement point. Undisturbed flow means avoiding sources of turbulence in the fluid such as valves, flanges, expansions, and elbows; avoiding swirl; and avoiding cavitation.

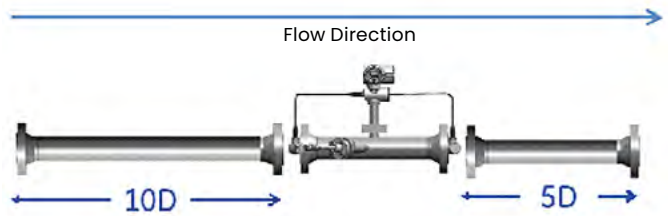


Figure 7: Flow Conditions

- Locate the transducers on a common axial plane along the pipe. Locate the transducers on the side of the pipe, rather than the top or bottom, since the top of the pipe tends to accumulate gas and the bottom tends to accumulate sediment. Either condition will cause increased attenuation of the ultrasonic signal. There is no similar restriction with vertical pipes as long as the flow of fluids is upward to prevent free falling of the fluid or a less than full pipe.

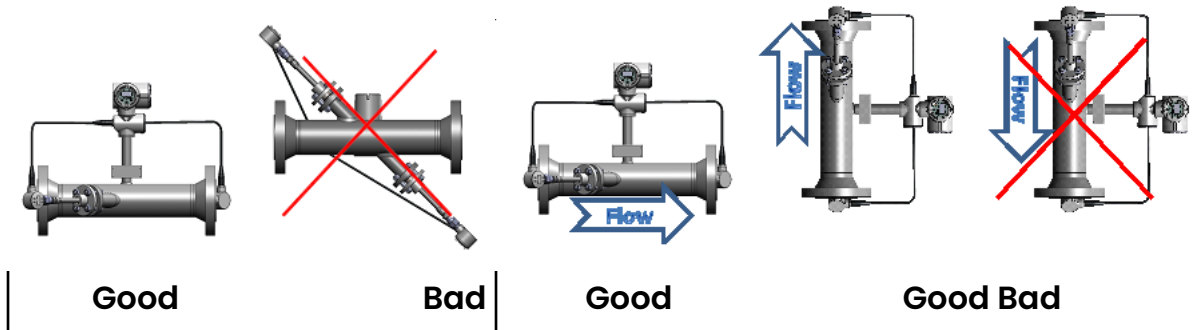


Figure 8: Good and Bad Transducer Locations



CAUTION!

Do not place insulation on or around the transducer or junction box. The transducer and junction box act as a heat sink that protects the transducer from high and low temperatures.

2.3.2 Electronics enclosure location (remote mount)

The standard PanaFlow HT electronics enclosure is a powder-coated, aluminum, IP67 explosion-proof enclosure. Typically, the enclosure is mounted as close as possible to the transducers. When choosing a site for remote mount installation, make sure the location permits easy access to the electronics enclosure for programming, maintenance and service. The maximum distance is 100 feet (30 meters).

Note: For compliance with the European Union's Low Voltage Directive, this unit requires an external power disconnect device such as a switch or circuit breaker. The disconnect device must be marked as such, clearly visible, directly accessible, and located within 1.8 m (6 ft) of the unit.

2.3.3 Cable lengths

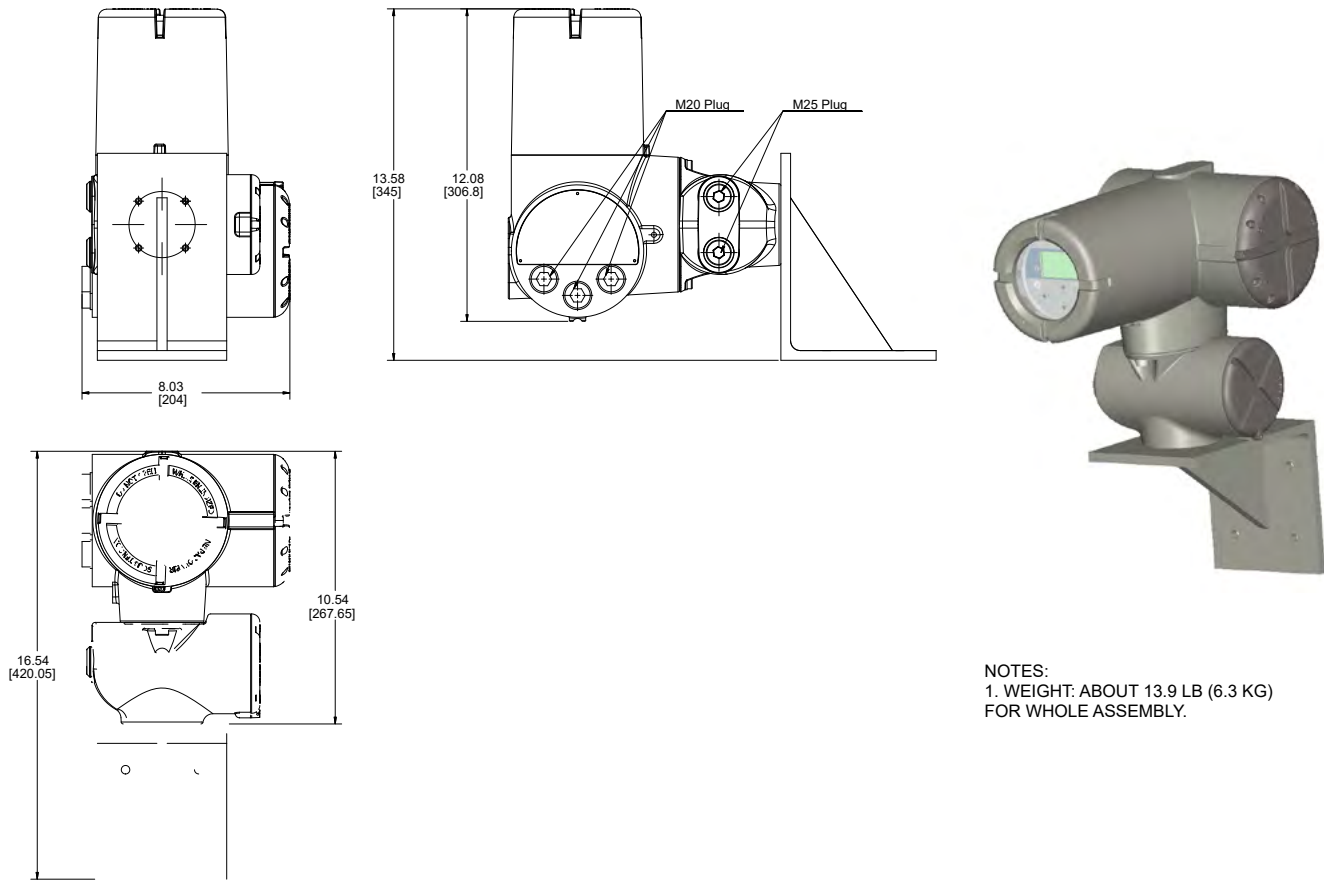
Locate the electronics enclosure as close as possible to the transducers, preferably directly on the flowcell. However, Panametrics can supply transducer cables up to 100 ft (30 m) in length for remote location of the electronics enclosure. If longer cables are required, consult the factory for assistance.

2.3.4 Transducer cables

When installing the transducer cables, always observe established standard practices for the installation of electrical cables. Do not route transducer cables alongside high amperage AC power lines or any other cables that could cause electrical interference. Also, protect the transducer cables and connections from the weather and corrosive atmospheres.

2.4 Mounting the electronics

The standard PanaFlow HT electronics package is housed in an IP67 weather-resistant enclosure suitable for indoor or outdoor use. See Figure 9 below for the mounting dimensions (remote mount only) and weight of the XMT900 electronics.



NOTES:
1. WEIGHT: ABOUT 13.9 LB (6.3 KG)
FOR WHOLE ASSEMBLY.

Figure 9: PanaFlow HT Electronics Package (Ref. Dwg. 712-1795)

2.5 Making electrical connections

This section contains instructions for making all the necessary electrical connections to the XMT900 flow transmitter.

Refer to Figure 10 for a complete wiring diagram.



WARNING!

To meet CE Mark requirements, all cables must be installed as described in Appendix G, CE Mark Compliance.

Refer to Figure 10 below and prepare the XMT900 for wiring by completing the following steps:

Terminal Block - Input/Output Connections

PIN	Label	Description
1	A-	Analog Output A:4-20mA/HART Output(SIL) Negative
2	A+	Analog Output A:4-20mA/HART Output(SIL) Positive
3	B-	Analog Output B:4-20mA Negative
4	B+	Analog Output B:4-20mA Positive
5	C-	Digital Output C Negative
6	C+	Digital Output C Positive
7	D-	Digital Output D Negative
8	D+	Digital Output D Positive

Terminal Block - Power Connection(AC)

PIN	Label	Description
1	L2/N	Neutral Connection
2	L1	Live Power Connection

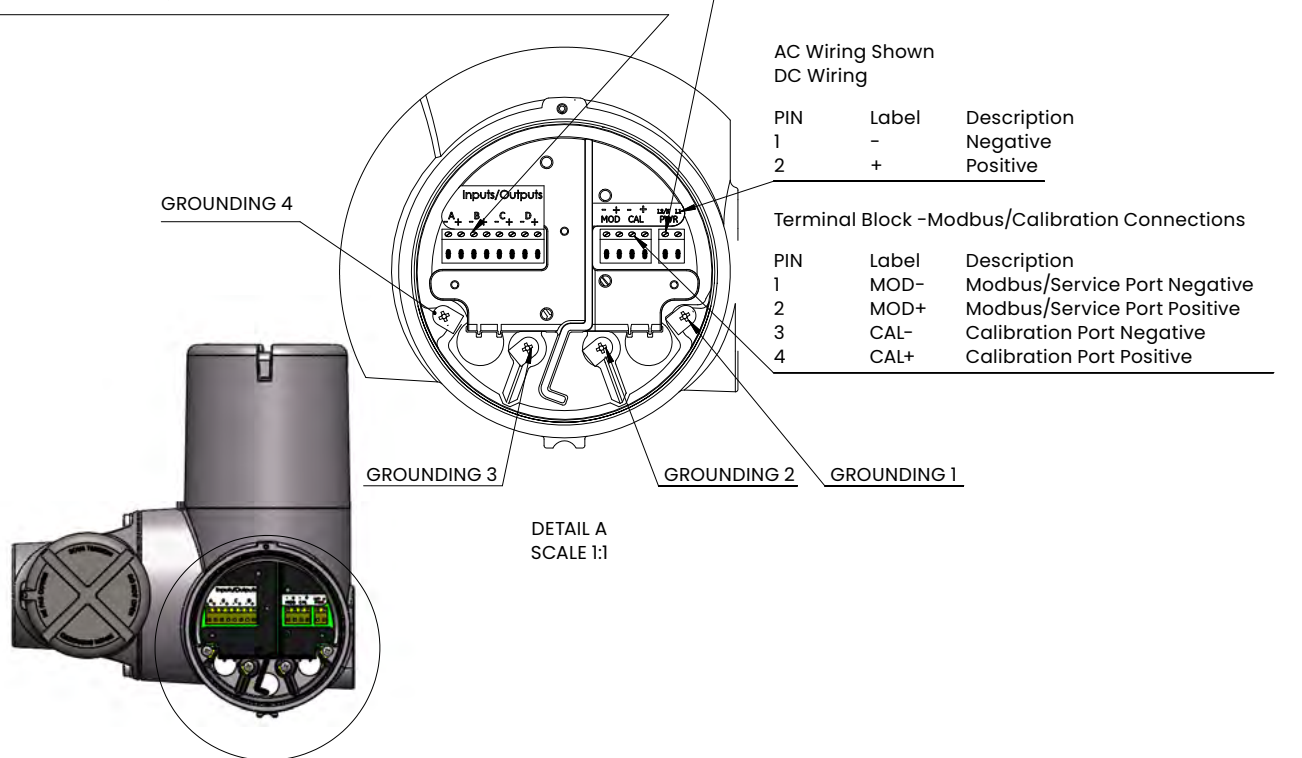


Figure 10: Wiring Diagram (Ref. Dwg. 702-1312)



WARNING!

Proper grounding of the PanaFlow HT chassis is required to prevent the possibility of electric shock. See Figure 10 above to locate the chassis grounding screw. All ground screws should be hand tightened only. Do not over-torque. Maximum torque is 2.5 N-m (22 in-lb).

2.5 Making electrical connections (cont.)



WARNING!

Always disconnect the line power from the PanaFlow HT before removing either the front cover or the rear cover. This is especially important in a hazardous environment.

1. Disconnect any previously wired power line from the unit.
2. Loosen the set screw on the wiring cover.
3. Place a rod or long screwdriver across the cover in the slots provided, and rotate the cover counterclockwise until it comes free from the enclosure.
4. Install any required cable clamps in the appropriate conduit holes on the opposite side of the enclosure.
5. Note the labels inside the rear cover to assist in wiring the power and option connections.

Proceed to the appropriate section of this chapter to make the desired wiring connections.

2.5.1 Preparing for wiring

Wiring any option set requires completion of the following general steps:

1. Disconnect the main power to the unit and remove the wiring cover.
2. Install a cable clamp in the chosen conduit hole on the side of the electronics enclosure and feed a standard twisted-pair cable through this conduit hole.
3. Locate the terminal block shown in Figure 10 on page 11 and wire the option as indicated on the label inside the wiring cover (see Figure 10 on page 11). Secure the cable clamp.



WARNING!

To meet CE Mark requirements, all cables must be installed as described in Appendix G, CE Mark Compliance.

4. If wiring of the unit has been completed, reinstall the wiring cover on the enclosure and tighten the set screw.

For more specific instructions on a particular output configuration, proceed to the appropriate sub-section.

2.5.2 Wiring analog outputs

The standard configuration of the PanaFlow HT flow transmitter includes one isolated 4–20 mA analog output with HART. Connections to these outputs may be made with standard twisted-pair wiring, but the current loop impedance for these circuits must not exceed 600 ohms. A second analog output is available as an option.

To wire the analog outputs, complete the following steps:

1. Disconnect the main power to the unit and remove the wiring cover.
2. Install the required cable clamp in the chosen conduit hole on the side of the electronics enclosure.
3. Refer to Figure 10 on page 11 for the location of the terminal block and wire the analog output as shown. Secure the cable clamp.



WARNING!

To meet CE Mark requirements, all cables must be installed as described in Appendix G, CE Mark Compliance.

Note: Analog Output A carries a HART signal. Whenever this becomes an open circuit or the load exceeds specifications, the output will go to 0 mA and the HART signal will be lost. This can happen if one disconnects the HART communicator while the circuit is live (hot swap). To restore HART communication, one must reset the unit. This can be done by power cycling the instrument, or by entering Configure mode and then exiting without making a change. (Select No at the “Save Changes?” prompt.)

IMPORTANT:

Analog Output A carries an active HART signal. Do not supply a 24 V supply to this circuit. The circuit is powered by the flowmeter.

4. If wiring of the unit has been completed, reinstall the wiring cover on the enclosure and tighten the set screw.



WARNING!

Make sure all covers, with their o-ring seals, are installed and the set screws tightened before applying power in a hazardous environment.

Note: Prior to use, the analog output must be set up and calibrated. Proceed to the next section to continue the initial wiring of the unit.

Note: Upon applying power to the instrument, the analog outputs will go to 24 mA before settling on a measurement value. This initial state of 24 mA is intended to signal to the Operator that the instrument is powered up and executing the initial self-test routines. The 24 mA state normally lasts only for a few seconds until flow measurements begin.

Note: See Appendix A, Specifications, for the load and voltage requirements.

2.5.3 Wiring digital outputs

Wiring any option set requires completion of the following general steps:

1. Disconnect the main power to the unit and remove the wiring cover.
2. Install the required cable clamp in the chosen conduit hole on the side of the electronics enclosure.
3. Refer to Figure 10 on page 11 for the location of the terminal block and wire the digital output (C and D) as shown. Secure the cable clamp.



WARNING!

To meet CE Mark requirements, all cables must be installed as described in Appendix G, CE Mark Compliance.

4. If wiring of the unit has been completed, reinstall the wiring cover on the enclosure and tighten the set screw.

Note: Prior to use, the option must be set up and calibrated. For more specific instructions on a particular output configuration, proceed to the appropriate sub-section.

Note: Digital Outputs can be configured as a totalizer pulse output, a frequency output, an alarms output or a control output.

2.5.3a Wiring as a totalizer (pulse) output

Wire this option in accordance with the connections shown on the label in the rear cover (see Figure 10 on page 11). Figure 11 below shows a sample wiring diagram of a totalizer output circuit. Refer to Appendix A, Specifications for the load and voltage requirements.

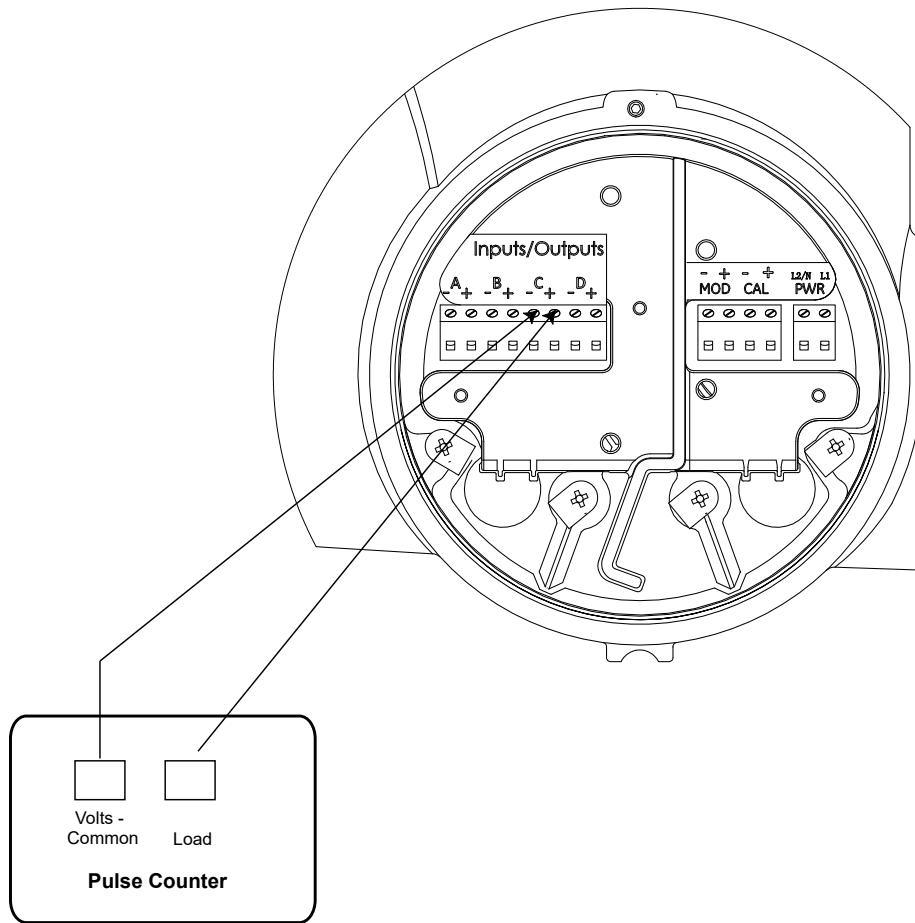


Figure 11: Wiring a Totalizer (Pulse) Output

2.5.3b Wiring as a frequency output

Wire this option in accordance with the connections shown on the label in the rear cover (see Figure 10 on page 11). Figure 12 below shows a sample wiring diagram of a frequency output circuit. Refer to Appendix A, Specifications for the load and voltage requirements.

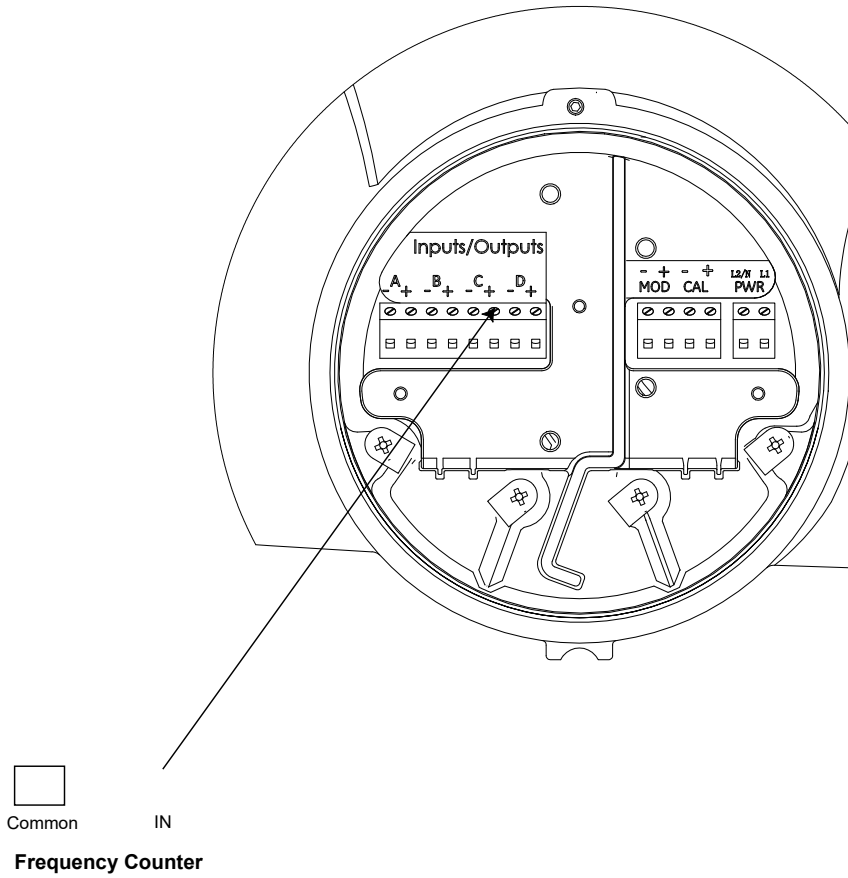


Figure 12: Wiring a Frequency Output

2.5.3c Wiring as alarms

When configured as Alarms, the Digital Output acts as an active, two-state output. The Alarm toggles from one state to the other based on a measurement condition. The “open” condition is 0 VDC and the “closed” condition is 5 VDC. The maximum electrical ratings for the relays are listed in Appendix A, Specifications. Each of the alarm relays can be programmed as either Normally Open (NO) or Normally Closed (NC). Connect each alarm relay in accordance with the wiring instructions shown in Figure 13 below and on the label in the rear cover (see Figure 10 on page 11). Refer to Appendix A, Specifications for the load and voltage requirements.

In setting up an alarm relay, it may be programmed for either conventional or fail-safe operation. In fail-safe mode, the alarm relay is held at “closed” (5 VDC), except when it is triggered or a power failure or other interruption occurs. Connect each alarm relay in accordance with the wiring instructions shown in Figure 13 below and on the label in the rear cover (see Figure 10 on page 11). Refer to Appendix A, Specifications for the load and voltage requirements.

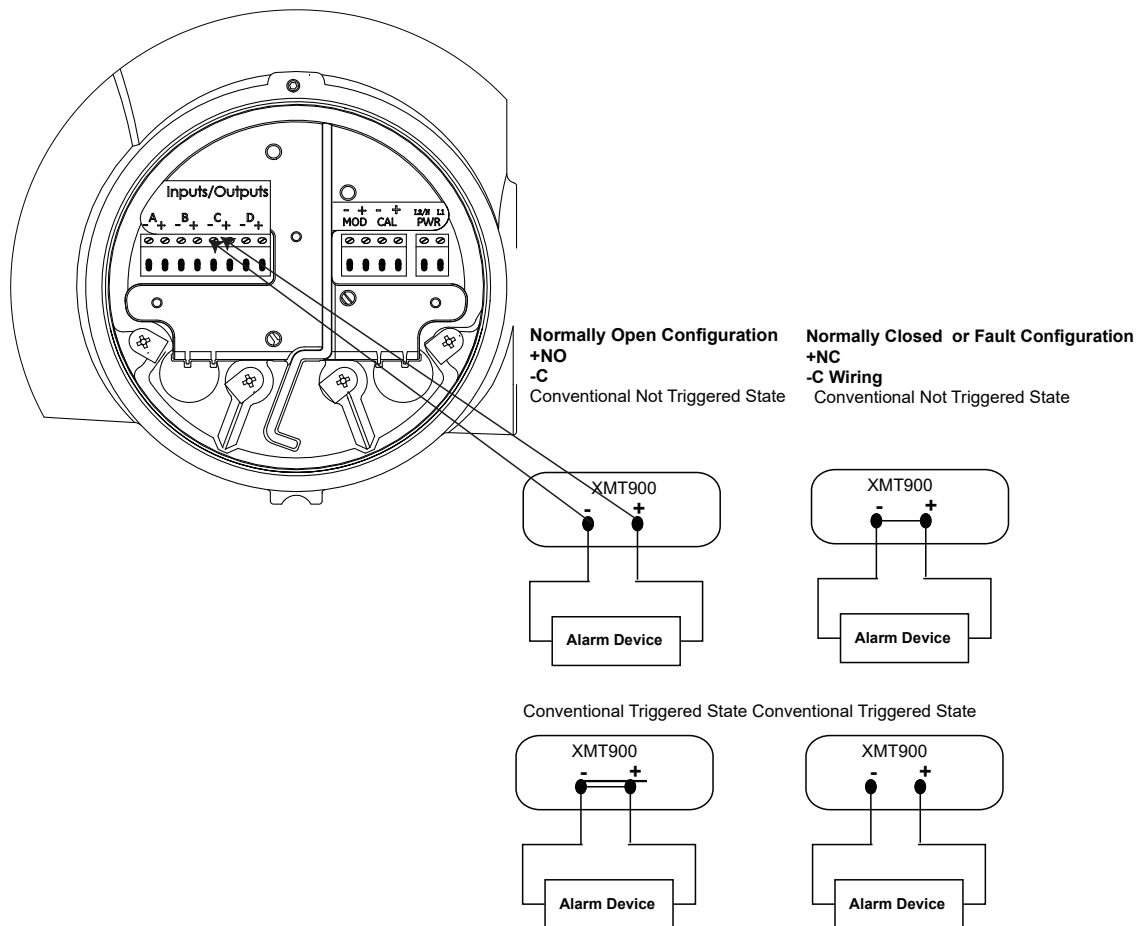


Figure 13: Wiring alarm outputs

2.5.3d Wiring as control output

The purpose of the Control Output is to generate a signal that can be used to control an external device based on a totalized measurement in the flowmeter. The Control State can be set to Normally Open or Normally Closed. The appropriate setting depends on the device being connected to the control output. The Control State indicates whether the Operator wants that switch to be Open or Closed until the point where the measured total threshold is reached. Once the flow totals reach the threshold level, the meter will switch the Control Output to the opposite state. If the system calls for the Control to be Open (0 VDC) until a certain flow

level is reached, the Operator should set the Control to Normally Open. At the measured threshold, the flowmeter will change the Control to Closed (5 VDC). If the system calls for the Control to be closed until a certain flow level is reached, the Operator should set the Control to Normally Closed. At the measured threshold, the flowmeter will change the Control to Open.

Connect each control output in accordance with the wiring instructions shown on the label inside of the rear cover (see Figure 10 on page 11) and in Figure 14 below.

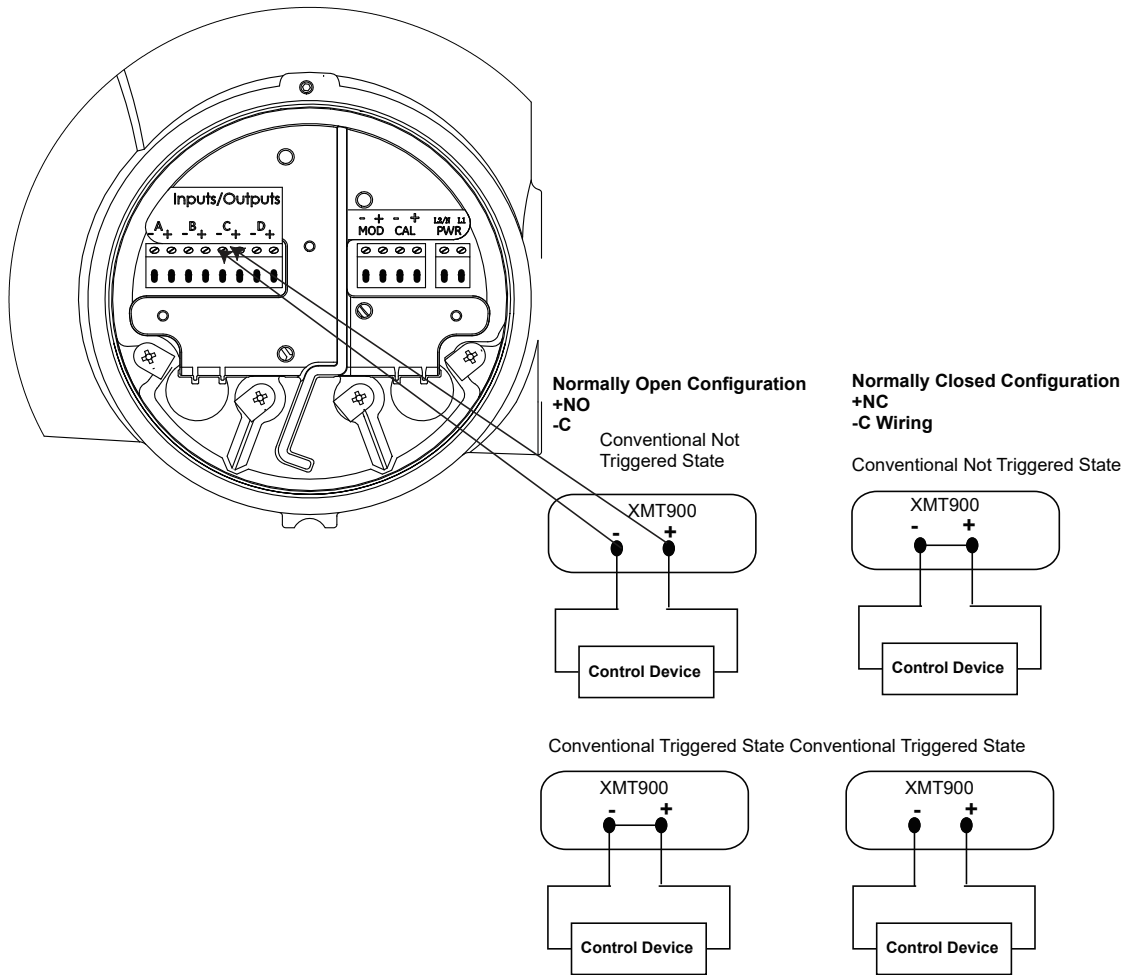


Figure 14: Control output connections

2.5.4 Wiring the modbus/service port

The XMT900 flow transmitter is equipped with a Modbus communication port for either a connection to Vitality (PC software) or to a separate control system. The port is an RS485 interface.

IMPORTANT:

The maximum cable length for an RS485 connection is 4000 ft (1200 m).

To wire to this RS485 serial port, refer to Figure 10 on page 11 and complete the following steps:

1. Disconnect the main power to the unit and remove the rear cover.
2. Install the required cable clamp in the chosen conduit hole on the side of the electronics enclosure.

3. Feed one end of the cable through the conduit hole, wire it as shown in Figure 15 below.
4. If wiring of the unit has been completed, reinstall the wiring cover on the enclosure and tighten the set screw.

Note: Prior to use, the serial port must be programmed.



WARNING!

Make sure all covers, with their o-ring seals, are installed and the set screws tightened before applying power in a hazardous environment.

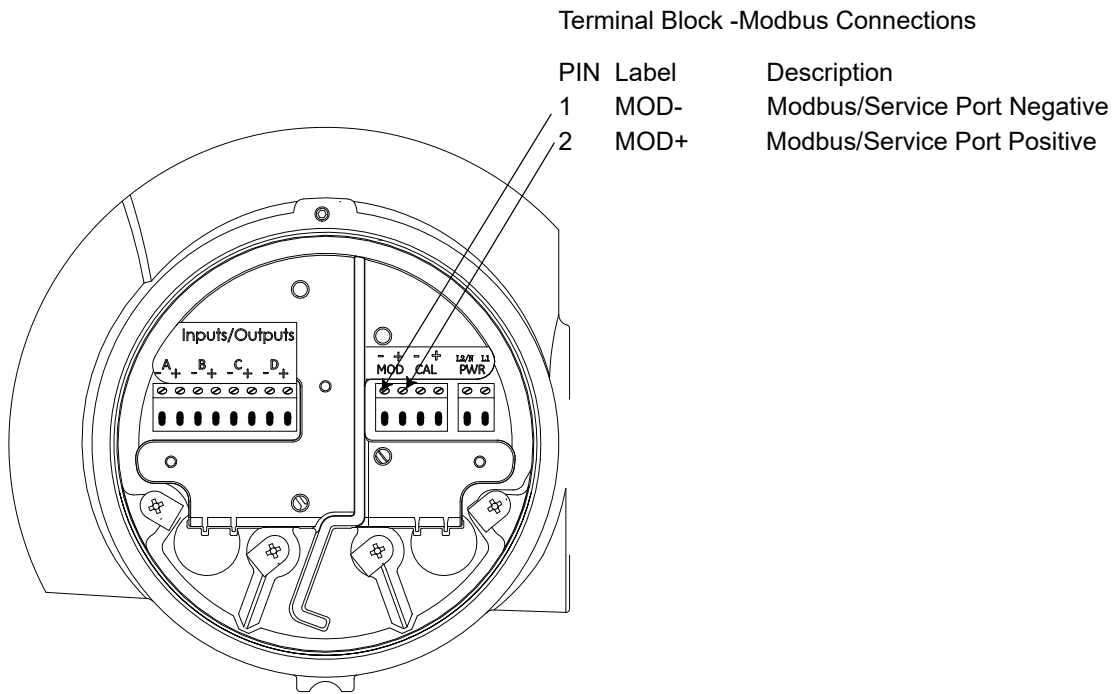


Figure 15: Modbus Connections

2.5.5 Wiring the calibration port

The XMT900 flow transmitter is equipped with a calibration port specifically designed for calibrating the PanaFlow HT. It is wired for a frequency output.

Note: Performing a calibration of the meter requires entering a Service-level password.

To wire to this port, refer to Figure 16 shown below and complete the following steps:

1. Disconnect the main power to the unit and remove the rear cover.
2. Install the required cable clamp in the chosen conduit hole on the side of the electronics enclosure.

3. Feed one end of the cable through the conduit hole, wire it to the terminal block.
4. If wiring of the unit has been completed, reinstall the wiring cover on the enclosure and tighten the set screw.



WARNING!

Make sure all covers, with their o-ring seals, are installed and the set screws tightened before applying power in a hazardous environment.

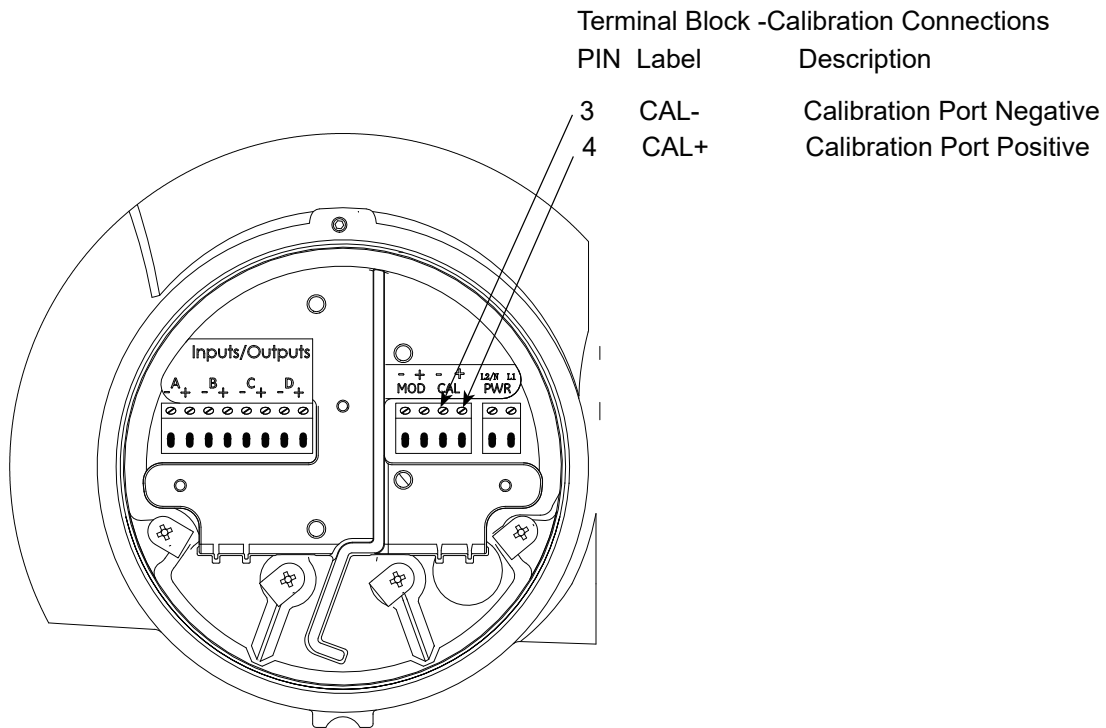


Figure 16: Calibration connections

2.5.6 Wiring the line power

The PanaFlow HT may be ordered for operation with power inputs of 100–240 VAC or 15–30 VDC. The label on the side of the electronics enclosure lists the meter's required line voltage and power rating. The fuse size is listed in Appendix A, Specifications. Be sure to connect the meter to the specified line voltage only.

Note: For compliance with the European Union's Low Voltage Directive, this unit requires an external power disconnect device such as a switch or circuit breaker. The disconnect device must be marked as such, clearly visible, directly accessible, and located within 1.8 m (6 ft) of the unit.



WARNING!

Improper connection of the line power leads or connecting the meter to the incorrect line voltage may damage the unit. It may also result in hazardous voltages at the flowcell and associated piping as well as within the electronics enclosure.

Refer to Figure 10 on page 11 to locate the terminal blocks and connect the line power as follows:

1. Prepare the line power leads by trimming the line and neutral AC power leads (or the positive and negative DC power leads) to a length 0.5 in. (1 cm) shorter than the ground lead. This ensures that the ground lead is the last to detach if the power cable is forcibly disconnected from the meter.

2. Install a suitable cable clamp in the conduit hole. If possible, avoid using the other conduit holes for this purpose, to minimize any interference in the circuitry from the AC power line.



WARNING!

To meet CE Mark requirements, all cables must be installed as described in Appendix G, CE Mark Compliance.

3. Route the cable through the conduit hole and connect the line power leads to the power terminal, using the pin number assignments shown in Figure 10 on page 11.
4. Leaving a bit of slack, secure the power line with the cable clamp.
5. If wiring of the unit has been completed, reinstall the wiring cover on the enclosure and tighten the set screw.



WARNING!

Make sure all covers, with their o-ring seals, are installed and the set screws tightened before applying power in a hazardous environment.



CAUTION!

The transducers must be properly wired before applying power to the meter.

2.6 Wiring transducers (remote mount cable)

For a PanaFlow HT remote-mounted version, only the remote mount cable must be connected between the meter body junction box and the XMT900 junction box (see Figure 17 below).

Transducer wiring to the meter body junction box and XMT900 electronics wiring to the XMT900 junction box is completed at the factory. After installing the meter body and XMT900 electronics, you must wire the remote cable.

Before wiring the PanaFlow HT remote mount cable, complete the following steps:

1. Disconnect the main power from the XMT900 electronics enclosure.
2. Install required adapters on the enclosure.

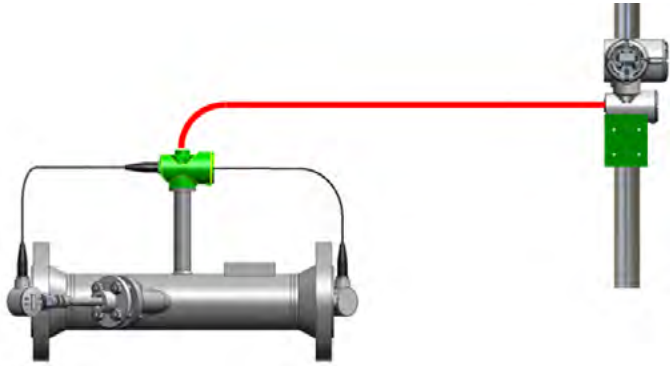


Figure 17: Remote cable wiring

2.6.1 Remote mount wiring instructions



WARNING!

Be sure to remove power before performing these steps.

The Transducer Junction box is in the lower chamber of the enclosure. For a remote-mount unit, a duplicate box is mounted on the pipe stand. Follow these instructions to connect the two junction boxes using the remote-mount cable supplied.

1. Loosen the set screw on the junction box cover and remove the cover.
2. Inside the wiring area of these two enclosures is a round printed circuit board with two mounting screws. Loosen the mounting screws, insert your fingers in the two 1-cm round holes, and twist the board counter-clockwise (in the direction of the arrows) approximately 2 cm to release it from the enclosure (see Figure 18 below). The board will remain wired to the system, but with enough slack to pull the board out about 5 cm. The transducer connections are on the other side of the board.

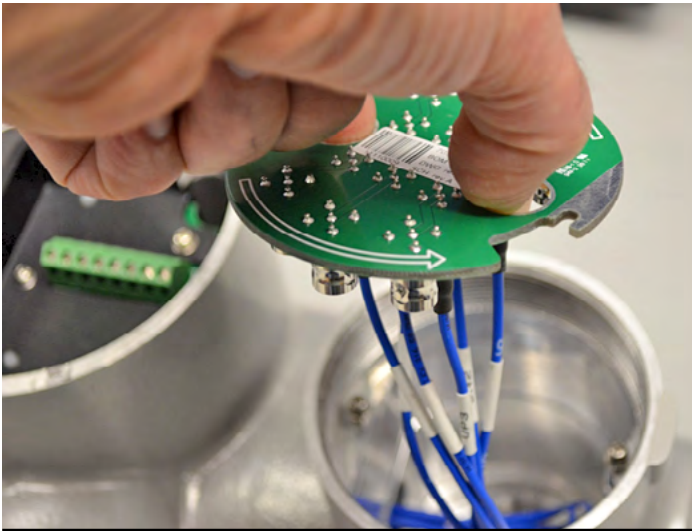


Figure 18: Removing the board

3. Make the mechanical connection between the remote cable and the junction boxes. Install the cable into the wiring port on each enclosure end and tighten the cable glands per the manufacturer's instructions.

Note: Refer to Figure 19 on page 24 while completing the following two steps.

4. At the Flowcell end, connect MCX cables from the remote mount cable to MCX connectors MCX-J1 (Ch1 Up) and MCX-J11 (Ch1 Dn). For a 2-channel system, also connect to MCX-J3 (Ch2 Up) and MCX-J9 (Ch2 Dn).
5. At the Electronics Enclosure end, connect BNC cables from the remote-mount cable to BNC connectors BNC-J1 (Ch1 Up) and BNC-J6 (Ch1 Dn). For a 2-channel system also connect to BNC-J2 (Ch2 Up) and BNC-J5 (Ch2 Dn).

2.6.1 Remote mount wiring instructions

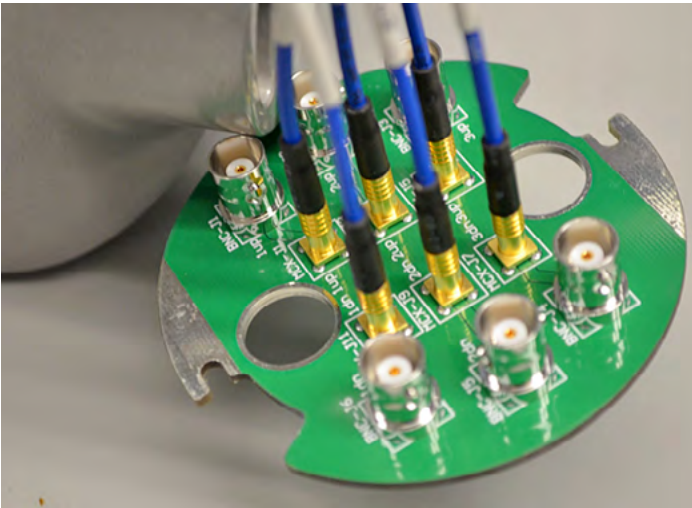


Figure 19: Wiring the cable

1. Check all BNC and MCX connections to be sure they are securely fastened. Then turn the board over, pushing the wires back into the enclosure with a counterclockwise twisting motion (see Figure 20 below).



Figure 20: Replacing the board

2. Finally, engage the two mounting screws with the washers on top of the board and securely fasten the board to the enclosure. Replace the cover and you are finished connecting the transducers. Engage the set screw on the enclosure for security.



WARNING!

Make sure all covers, with their o-ring seals, are installed and the set screws tightened before applying power in a hazardous environment.

Chapter 3. Initial setup and programming

3.1 Introduction

This chapter provides instructions for programming the PanaFlow HT flowmeter to place it into operation. Before the PanaFlow HT can begin taking measurements, settings for the User Preferences, Inputs/Outputs, and SIL testing must be entered and tested.

3.2 User restrictions

If a Dangerous Detected state occurs, the flowmeter will put the SIL Output in the DD state and remain that way until an Authorized User intervenes. The DD state can be cleared by executing a reset of the flowmeter. There are two methods for clearing the DD state:

- Enter the Program menu at SIL user access level. Then, exit without making any changes. The flowmeter will execute a soft reset. Or,
- Turn the power off, and wait for one minute. Then, turn the power back on.

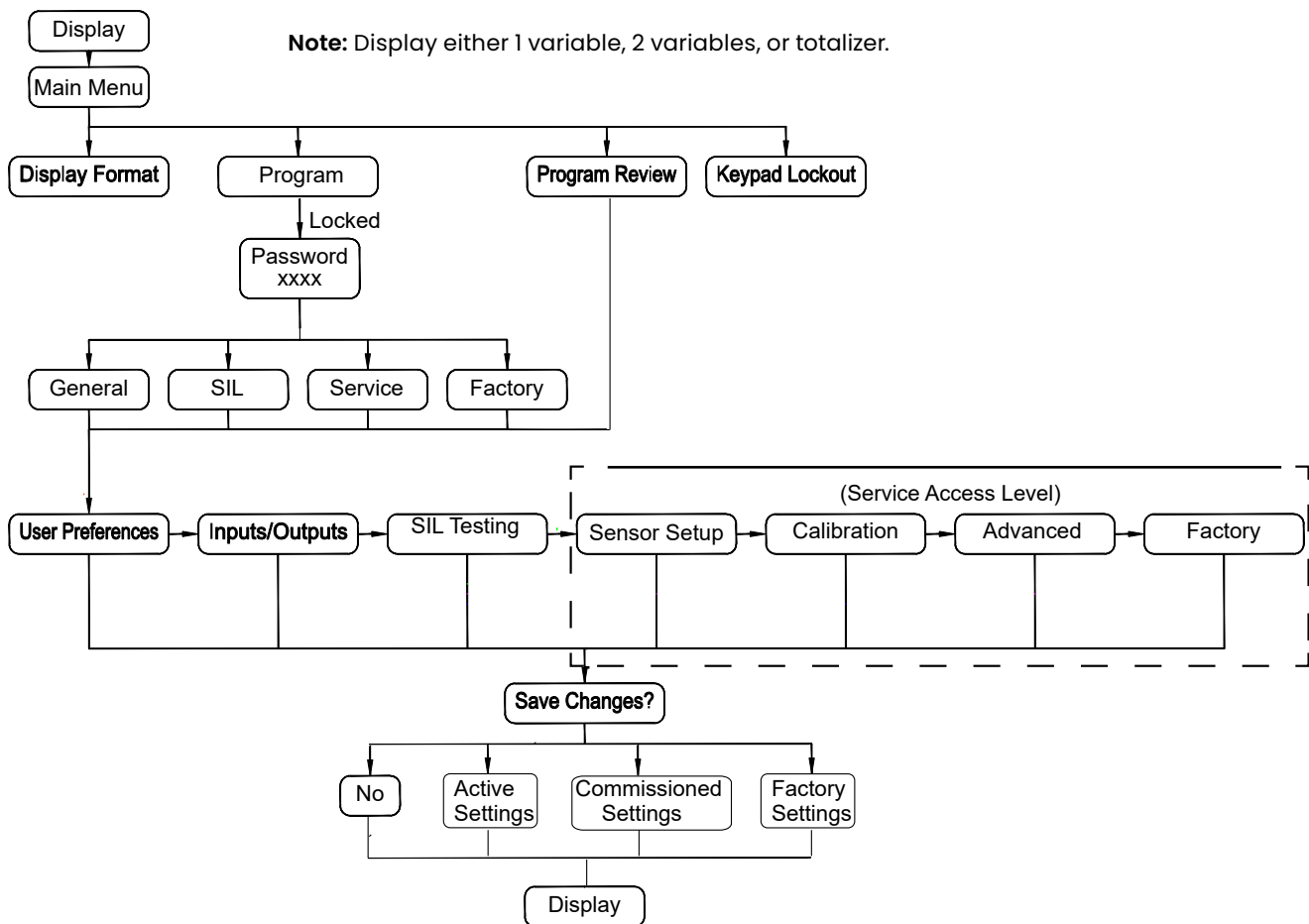


Figure 21: High level menu map

3.2 User restrictions (cont.)

Notice that, at the bottom of Figure 21 on page 25, there are four options for Save Changes?. Selecting No will discard any program changes and reset the instrument and restart Measure mode. The other three options are Active Settings, Commissioned Settings, and Factory Settings. They allow the instrument to store three complete sets of program data.

Note: The option to save as Commissioned Settings is only available if the operator has Service or Factory access level. The option to save as Factory Settings is only available from the Factory access level.

The purpose of these extra data sets is to allow the instrument to be restored to those saved settings as a troubleshooting measure. If at any point there is an error in

the Active Data Set (the set of parameters used in Measure mode), the Authorized User may revert the Active Data Set to the Commissioned Data Set. This will return the flowmeter to a known working condition, the way it was programmed when a Panametrics Service Professional first commissioned the product on site. As a secondary redundant measure, the Authorized User may revert the Active Data Set to the Factory Data Set if there is an issue with the Commissioning Data Set. This returns the instrument to the way it was programmed when it was calibrated prior to shipment. Since the integrity of the SIL Output is so critical, the flowmeter maintains all three data sets in its memory as a backup in case of error.

3.3 PanaFlow HT enclosure magnetic keypad

The window at the top of the PanaFlow HT enclosure includes the components shown in Figure 22 below.



Figure 22: The enclosure window

IMPORTANT:

The PanaFlow HT magnetic keypad enables programming of the instrument through the glass faceplate without removing the cover. Thus, all programming procedures may be performed while the unit is installed in a hazardous area.

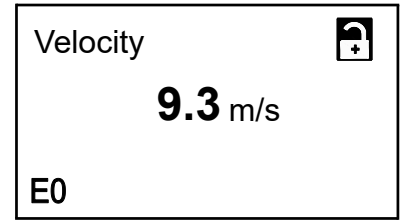
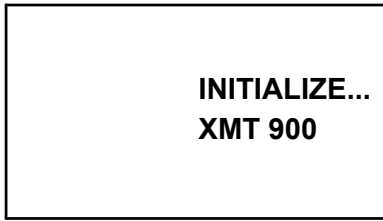
Above the display, the red light is the power indicator and the green light is the system health indicator. After the system power is applied, the red light will stay on until power is lost. The green light will only be on when the system is taking measurements without error. If the instrument detects any error, the green light will turn off. Also, when the Operator enters Configure mode, the instrument stops measuring and the green light will be off.

The following six keys on the magnetic keypad enable users to program the PanaFlow HT:

- [✓] - confirms the choice of a specific option and data entry within the option.
- [x] - enables users to exit from a specific option without entering the unconfirmed data.
- [△] and [▽] - enable users to highlight a specific window in the display option or to scroll through a list of menu options such as: parameters, letters, numbers 0-9, the negative sign and the decimal point.
- [◀] and [▶] - enable users to scroll to a specific option, among the available choices, or to the desired character in a text entry box.

3.3 PanaFlow HT enclosure magnetic keypad (cont.)

When the PanaFlow HT is powered up, the initial screen display appears, followed by a display of measurement parameters.



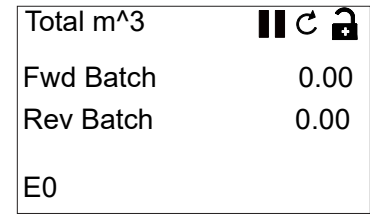
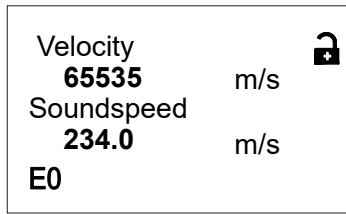
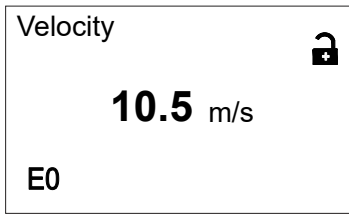
As a guide to following the programming instructions in this chapter, the relevant portions of the PanaFlow HT menu map have been reproduced in Figure 31 on page 93 and Figure 32 on page 94.

IMPORTANT:

If the keypad has not been pressed for 10 minutes, the PanaFlow HT exits the Keypad Program and returns to displaying measurements. The meter discards any unconfirmed configuration changes. Any entered changes are only retained after the user confirms them.

3.4 Display programming

The XMT900 has can display one variable, two variables, or totalizers, as shown below. From this display, you can scroll to and change either the measurement type or the number of decimal places using the [◀] and [▶] buttons.

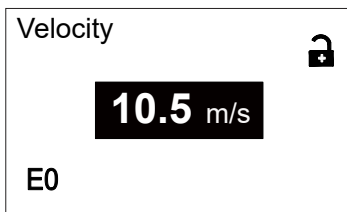


3.4.1 Changing value for one or two-variable screens the components of a typical one-variable screen are shown below.

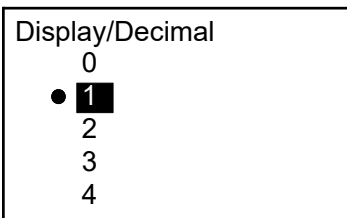


Figure 23: Typical one-variable screen

To change the number of decimal places in the displayed value, proceed as follows:



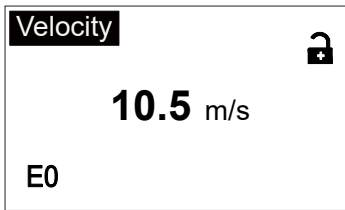
From the display screen, press either the [◀] or [▶] buttons until the value is highlighted. Then, press [✓] to open the Display/Decimal option.



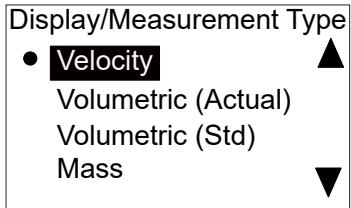
Use the [△] and [▽] buttons to scroll to the appropriate value. (Available options include 0, 1, 2, 3, 4, and Sci (Scientific Notation)). Press [✓] to select the value, and then [✓] again to confirm the selection or [✗] to cancel the selection.

3.4.2 Changing measurement type for one- or two-variable screens

To change the displayed measurement type, proceed as follows:



From the display screen, press either the [◀] or [▶] buttons until the measurement type is highlighted. Then, press [✓] to open the Display/Decimal option.



The screen changes to Display/Measurement Type. Press the [△] and [▽] buttons to scroll to the desired parameter. Available parameters include: velocity, volumetric (actual), volumetric (standard), mass, batch total, inventory total, soundspeed, KFactor, Reynolds number and diagnostics. After you have chosen the measurement type, press [✓] to select the value, and then [✓] again to confirm the selection or [x] to cancel the selection.

Note: To select a particular measurement unit, go to “Flow Units” on page 43.

Parameter	Metric units		Imperial units	
Velocity	m/s	meters/sec	ft/s	feet/sec
Volumetric - Actual	L/S	Liters per Second	GAL/S	Gallons per Second
	L/M	Liters per Minute	GAL/M	Gallons per Minute
	L/H	Liters per Hour	GAL/H	Gallons per Hour
	ML/D	Mega Liters per Day	GAL/D	Gallons per Day
	m3/S	Cubic Meter per Second	ft3/S	Cubic Feet per Second
	m3/M	Cubic Meter per Minute	ft3/M	Cubic Feet per Minute
	m3/H	Cubic Meter per Hour	ft3/H	Cubic Feet per Hour
	m3/D	Cubic Meter per Day	ft3/D	Cubic Feet per Day
	BBL/S	Barrels per Second	BBL/S	Barrels per Second
	BBL/M	Barrels per Minute	BBL/M	Barrels per Minute
	BBL/H	Barrels per Hour	BBL/H	Barrels per Hour
	BBL/D	Barrels per Day	BBL/D	Barrels per Day
	KGAL/M	Kilo gallons per Minute	KGAL/M	Kilo gallons per Minute
KGAL/H	Kilo gallons per Hour	KGAL/H	Kilo gallons per Hour	
KGAL/D	Kilo gallons per Day	KGAL/D	Kilo gallons per Day	
Volumetric - Actual (cont.)	KBBL/M	Kilobarrels per Minute	KBBL/M	Kilobarrels per Minute
	KBBL/H	Kilobarrels per Hour	KBBL/H	Kilobarrels per Hour
	KBBL/D	Kilobarrels per Day	KBBL/D	Kilobarrels per Day

Table 1: Available parameters and units

Parameter	Metric units		Imperial units	
Volumetric – Standard	SL/S	Standard Liters per Second	SCFH	Standard Cubic Feet Per Hour
	SL/M	Standard Liters per Minute	SCFM	Standard Cubic Feet Per Minute
	SL/H	Standard Liters per Hour		
	SML/D	Standard Mega Liters per Day		
	Sm ³ /S	Standard Cubic Meter per Second		
	Sm ³ /M	Standard Cubic Meter per Minute		
	Sm ³ /H	Standard Cubic Meter per Hour		
	Sm ³ /D	Standard Cubic Meter per Day		
Mass flow	KG/S	Kilograms per Second	LB/S	Pounds per Second
	KG/M	Kilograms per Minute	LB/M	Pounds per Minute
	KG/H	Kilograms per Hour	LB/H	Pounds per Hour
	KG/D	Kilograms per Day	LB/D	Pounds per Day
	TNE/S	Metric Tons (1000 KG) per Second	KLB/S	KiloPounds per Second
	TNE/M	Metric Tons (1000 KG) per Minute	KLB/M	KiloPounds per Minute
	TNE/H	Metric Tons (1000 KG) per Hour	KLB/H	KiloPounds per Hour
	TNE/D	Metric Tons (1000 KG) per Day	KLB/D	KiloPounds per Day
			SHTN/S	Short Tons Per Second
			SHTN/M	Short Tons Per Minute
			SHTN/H	Short Tons Per Hour
			SHTN/D	Short Tons Per Day
Volumetric (actual) totals	L	Liters	MGAL	Mega U.S. Gallons
	ML	Mega Liters	ft ³	Cubic Feet
	m ³	Cubic Meter	BBL	Barrels
	BBL	Barrels	MBBL	Mega Barrels
	MBL	Mega Barrels	AC-IN	Acre-inches
	KG	Kilograms	AC-FT	Acre-feet
	Tonnes	Metric Tons (1000 KG)	LB	Pounds
Volumetric (standard) totals	SL	Standard Liters	Sft ³	Standard Cubic Feet
	Sm ³	Standard Cubic Meter		

Table 1: Available parameters and units (cont.)

Parameter	Metric units		Imperial units	
Mass totals	kg	kilograms	LB	pounds
	t	Tonnes		
Density	kg/m ³	kilograms per cubic meter	LB/ft ³	pounds per cubic foot
Temperature	K	Kelvin	F	degree Fahrenheit
	C	degree Celsius	R	degree Rankine
Dimension	m	meter	ft	feet
	mm	millimeter	in	inch
Time	s	second		
	ms	Milli second		
	us	Micro second		
	h	Hour		
Frequency	Hz	Hertz		
	MHz	Mega Hertz		
	kHz	Kilo Hertz		
Current	amp	Ampere		
	ma	Milli ampere		

Table 1: Available parameters and units (cont.)

3.4.3 Changing the measurement type or value for totalizer screens

A typical totalizer screen is shown in Figure 24 below.

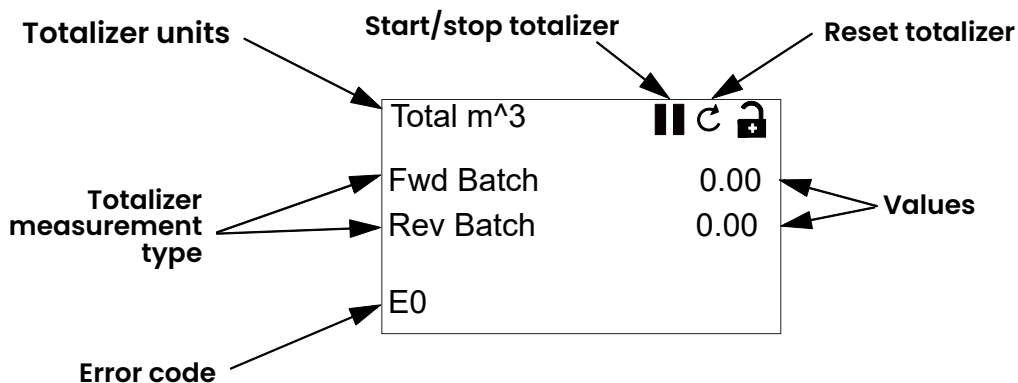
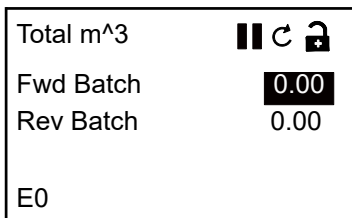
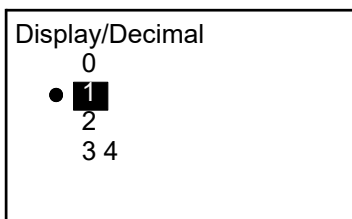


Figure 24: The totalizer screen

To change the number of decimal places in the value displayed on a totalizer screen, proceed as follows:



From the display screen, press either the [\leftarrow] or [\rightarrow] buttons until one of the values is highlighted. Then, press [\checkmark] to open the Display/Decimal option.



Use the [Δ] and [∇] buttons to scroll to the appropriate value. (Available options include 0, 1, 2, 3, 4, and Sci (Scientific Notation)). Press [\checkmark] to select the value, and then [\checkmark] again to confirm the selection or [\times] to cancel the selection.

3.4.3 Changing the measurement type or value for totalizer screens (cont.)

To change the totalizer measurement type, proceed as follows:

Total m ³	C 🔒
Fwd Batch	0.00
Rev Batch	0.00
E0	

From the display screen, press either the [◀] or [▶] buttons until the desired measurement type is highlighted. Then, press [✓] to open the Display/Decimal option.

Display/Measurement Type	
• Forward Batch	
Reverse Batch	
Net Batch	
Batch Time	

The screen changes to Display/Measurement Type. Press the [△] and [▽] buttons to scroll to the desired parameter. Available parameters include: velocity, volumetric (actual), volumetric (standard), mass, batch total, inventory total, soundspeed, KFactor, Reynolds number and diagnostics. After you have chosen the measurement type, press [✓] to select the value, and then [✓] again to confirm the selection or [X] to cancel the selection.

If you select Batch Time as the display parameter, you can also select the time measurement units as seconds, minutes, hours or days as follows:

Total m³	C 🔒
Batch Time	0.00
Rev Batch	0.00
E0	

From the highlighted measurement type, press either the [◀] or [▶] buttons until the measurement unit is highlighted. Then, press [✓] to open the Display/Decimal option.

Display/Unit	
• m³	
ft ³	
GAL	
MGAL	

Press the [△] and [▽] buttons to scroll to the desired unit, and press [✓] to select the unit, and then [✓] again to confirm the selection or [X] to cancel the selection.

Note: If you selected "Batch Time" as the display parameter, the available units are seconds, minutes, hours and days.

3.4.4 Starting or stopping totalizer measurement

To start or stop totalizer measurements, proceed as follows:



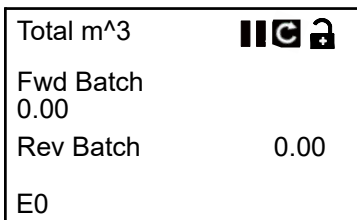
From the highlighted measurement type, press either the [\leftarrow] or [\rightarrow] buttons until the Start/Stop icon (either an arrow icon for Start or a two-bar icon for Stop) is highlighted.



Press [\checkmark] to start a stopped totalizer or to stop an active totalizer. The icon then changes to indicate the new status (start or stop).

3.4.5 Resetting the totalizer

To reset the totalizer, proceed as follows:



From the display screen, press either the [\leftarrow] or [\rightarrow] buttons until the Reset icon (a partial circle with an arrow head) is highlighted. After the Reset icon has been highlighted, press [\checkmark] to reset the totalizer to 0.

3.5 Entering the main menu

A map of the main menu is shown in Figure 25 below. Entry to the main menu is gained via one of the following methods:

- **Locked:** If the main menu is locked, as indicated by a closed lock icon at the upper right side of the display, you will be required to enter a valid password before gaining access to the main menu.
- **Unlocked:** If the main menu is unlocked, as indicated by an open lock icon at the upper right side of the display, you will gain immediate access to the main menu.

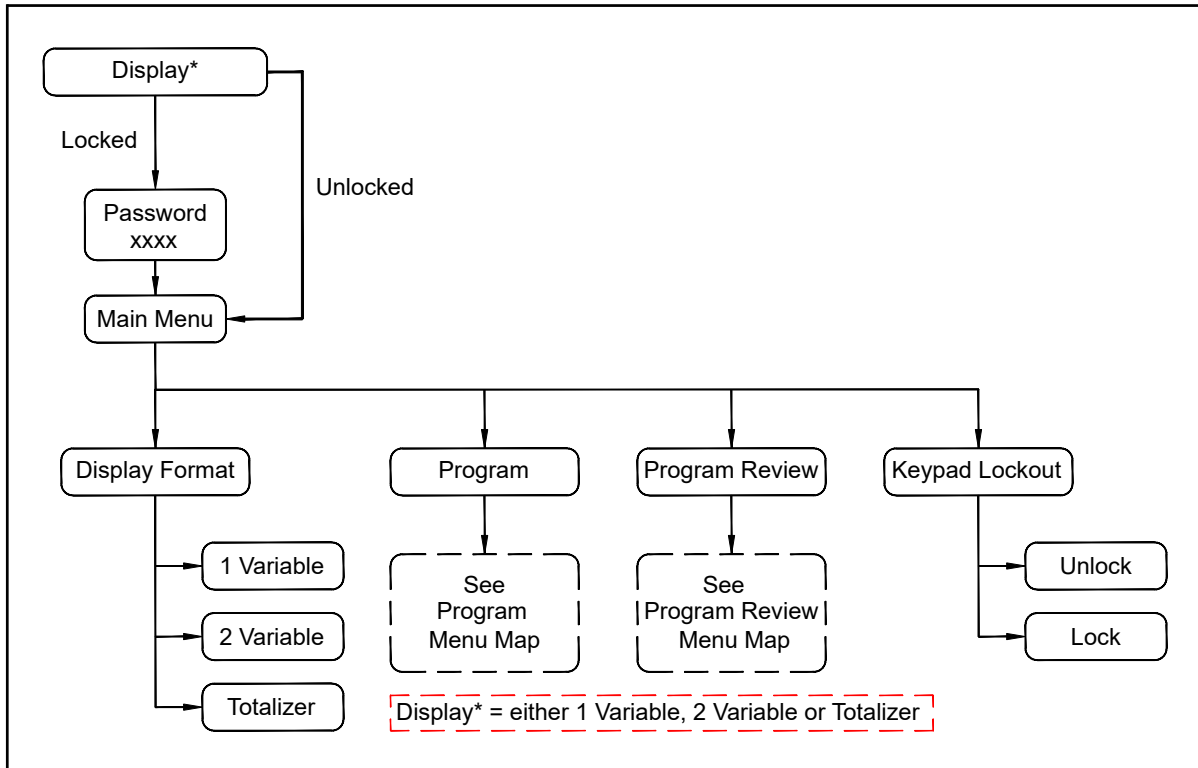
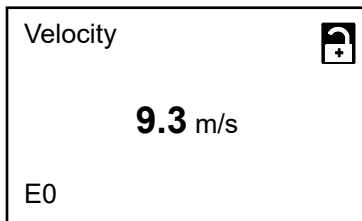


Figure 25: Main Menu Map

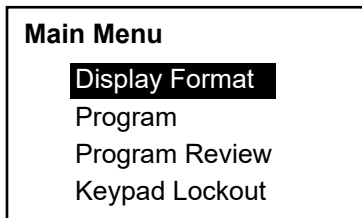
3.5.1 Display format

To begin programming your meter, you must select the system units as described below. Refer to Figure 31 on page 93 and remember to record all programming data in Appendix F, Data Records.

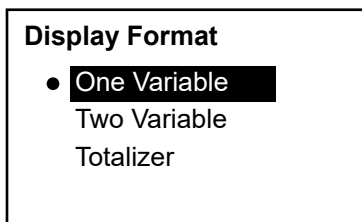
The Display Format submenu is used to set up the type of format used to display information.



On the initial screen, use the [◀] and [▶] buttons to highlight the lock symbol, then press [✓]. The following screen appears.

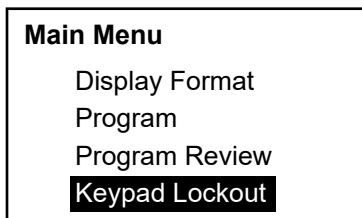


Use the [◀] or [▶] buttons to highlight Display Format and press [✓]. The following screen appears.

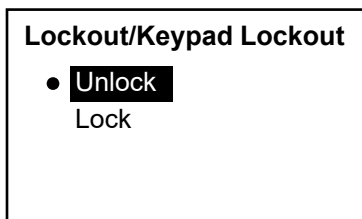


Use the [◀] or [▶] buttons to highlight the desired format setup and press [✓]. The window returns to the previous screen.

3.5.2 Keypad lockout



To lock or unlock the keypad for security, on the Main menu, select Keypad Lockout and press [✓]. A screen similar to the following appears.



To lock the display, press the [◀] or [▶] buttons to highlight Lock and press [✓]. The screen returns to the previous display.

Note: When the keypad is locked, press [x], [✓], [x] in rapid sequence to open the password screen. Then enter either a General User, SIL User, Service or Factory password to unlock the keypad.

3.5.3 Program/program review

The Program and Program Review menus enable the setting up or viewing of several categories of information at different security levels (see Figure 26 below). As discussed previously, the ability to edit parameters depends on the access level. The next section will explicitly state which access level is required to edit each of the parameters. To view all parameters without editing, select Program Review.

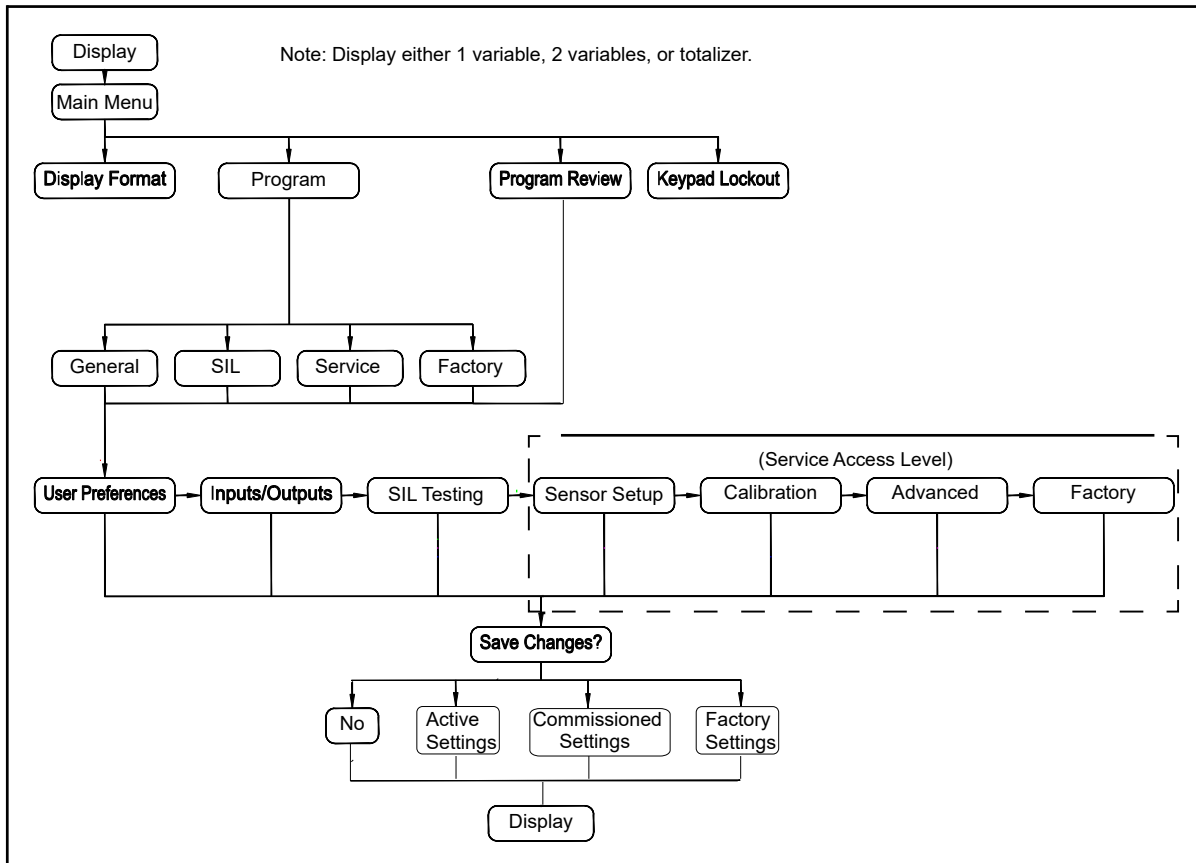


Figure 26: Programming and program review menu map

3.5.4 Program review

The Program Review menu requires no user password. However, it provides view-only access to the screens. To change any setting or parameter, you must enter the Program Menu and supply a password of the appropriate level.

3.5.5 Program mode

IMPORTANT:

Measurements will stop and the SIL output will go to dangerous detected level (error level) when you enter Program (configure) mode, as shown in F below.

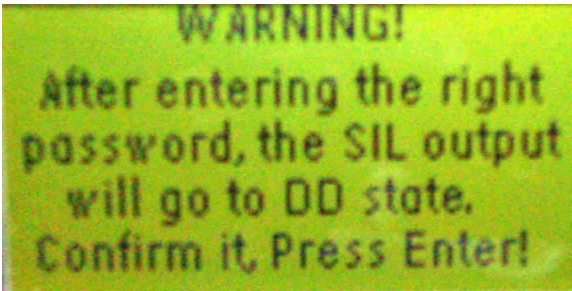


Figure 27: SIL Warning Screen

3.5.5a Enter programming

Display/Lockout

Display Format
Program
Program Review
Keypad Lockout

To enter the Programming menu from the Display/Lockout menu, use the [◀] or [▶] buttons to highlight Program and press [✓]. The following screen appears.

3.5.5b Access levels

Main Menu

• **Gen User**
SIL User
Services
Factory

There are four levels of information access: General, SIL, Service and Factory. Each level requires that a password be entered. Use the arrow keys to highlight the appropriate level and press [✓]. The following screen appears.

Enter the password

9999
[✓] SAVE [X] QUIT
[◀▶] MOVE [▲▼] MODE

To enter the password, use the [◀] or [▶] buttons to select each digit to be changed and the [▲] or [▼] buttons to change the value of the selected digit. When the password number is correct, press [✓] and the following screen appears.

3.6 User preferences



CAUTION!

Changing program parameters could result in an inaccuracy in the flow measurement, which could violate the functional safety of the product. Always use caution when changing parameters at the SIL User Level. These parameters, which are functional safety related, shall be entered and validated by a suitably skilled and qualified person (i.e., an Authorized User).

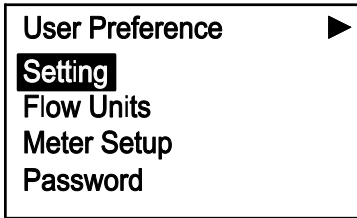
Any changes made at the SIL User Level must be followed by a validation step. There are two components to the validation process:

1. Review the parameter changes before committing them to the flowmeter. This process is automatically initiated by the programming interface (i.e., display/ keypad, Vitality software, or HART). Be sure the program parameters are correct before issuing the Commit command.
2. After returning to Measure Mode, review the measurement parameters in Table 2 below to verify that they are in an acceptable range. This completes the validation process.

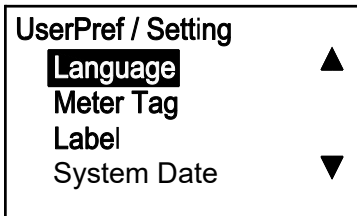
Measurement	Expected	Actual	Criteria	Verdict (P/F)
Ch1 Sound Speed			< 0.5% difference	
Ch1 Velocity			< 0.5% difference	
Ch1 Up Amp Discriminator			> 14 and < 32	
Ch1 Dn Amp Discriminator			> 14 and < 32	
Ch1 SNR Up	> 10		> 5	
Ch1 SNR Dn	> 10		> 5	
Ch1 Active TWup			Within ±15% of the static TW value.	
Ch1 Active TWdn			Within ±15% of the static TW value.	
Ch1 Error Status	0x00000000		0x00000000	
Ch1 Error #	0		< 8	
Ch2 Sound Speed			< 0.5% difference	
Ch2 Velocity			< 0.5% difference	
Ch2 Up Amp Discriminator			> 14 and < 32	
Ch2 Dn Amp Discriminator			> 14 and < 32	
Ch2 SNR Up	> 10		> 5	
Ch2 SNR Dn	> 10		> 5	
Ch2 Active TWup			Within ±15% of the static TW value.	
Ch2 Active TWdn			Within ±15% of the static TW value.	
Ch2 Error Status	0x00000000		0x00000000	
Ch2 Error #	0		< 8	
Composite Velocity			< 0.5% difference	
Composite Volumetric			< 0.5% difference	
SIL Output mA			4 mA ≤ x ≤ 20 mA	

Table 2: Criteria for SIL Requirements

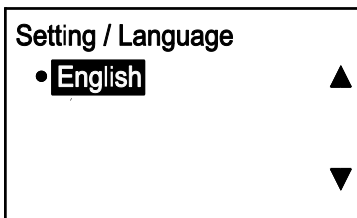
3.6.1 Settings



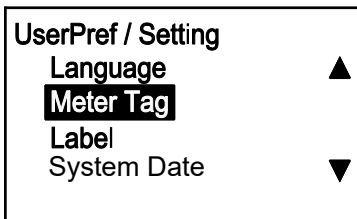
To check or change the desired settings, under User Preference, select Settings and press [✓]. The following screen appears.



To change the language being used, highlight Language and press [✓]. The following screen appears.

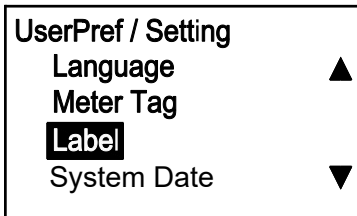


Use the [△] or [▽] buttons to select the desired language and press [✓] twice. Note that only English is currently available. The screen returns to the previous display.



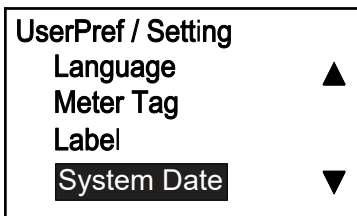
To check the Meter Tag, highlight your choice on the UserPref/Setting menu and press [✓]. Press [x] to return to the previous screen.

Note: You can only change the Meter Tag using the Vitality software.



To check the Label, highlight your choice on the UserPref/Setting menu and press [✓]. Press [x] to return to the previous screen.

Note: You can only change the Label data using the Vitality software.



To check or change the date/time, highlight System Date and press [✓]. The following screen appears.

3.6.1 Settings (cont.)

Set System Time...	
Date: 11/21/2011	
Time: 08:45:09	
[X] QUIT	[✓] SAVE
[◀▶] MOVE	[▲▼] MODE

Use the [△] or [▽] buttons to select the desired response and press [✓]. The screen returns to the previous display.

UserPref/Setting	
Meter Tag	▲
Label	
System Date	
SIL Limits	▼

The next option is for the SIL Limits. There are four flow limits related to functional safety that the operator may choose to set. In most cases, the default values for these limits do not need to be changed.

To enter the SIL Limits option, highlight SIL Limits and press [✓].

Note: To enter this option, you must enter a SIL User or higher level password.

SIL Limits	
Low Sil	-12.2000m/s
Low Warn	-12.2000m/s
Up Warn	12.2000m/s
Up Sil	12.2000m/s

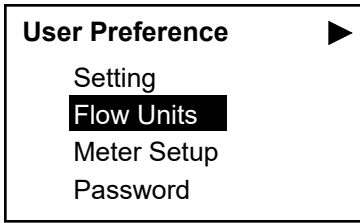
Use the [△] or [▽] buttons to enter the SIL limits and press [✓]. The four SIL limits are the Lower Functional Limit (LFL), Lower Warning Limit (LWL), Upper Warning Limit (UWL), and Upper Functional Limit (UFL). The LFL and UFL are defaulted to the system design limits and do not need to be changed unless the operator chooses to set an upper and lower flow rate that is critical to the safety of the SIS. The LWL and UWL only need to be set if the LFL and UFL are used. The Safety Manual describes SIL limits in much greater detail.

UserPref/Setting	
System Date	▲
SIL Limits	
Density	▼
Kinematic Viscosity	

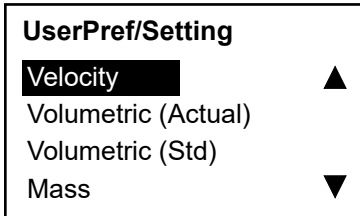
After setting the SIL Limits, select Density to set the static and reference density. Mass Flow is calculated by multiplying the measured value of Volumetric Flow by the static density. Standardized Volumetric Flow is calculated by multiplying the measured value of Volumetric Flow by the ratio of static density to the reference density.

Continuing with the same procedure described above, enter a static value for the Kinematic Viscosity in centistokes. This value is used to determine the Reynolds number correction factor for the flow measurement.

3.6.2 Flow units

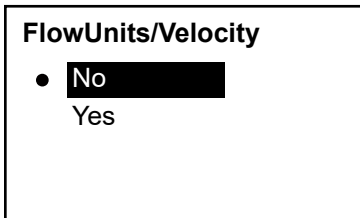


To check or change the flow units in the User Preference menu, use the [Δ] or [▽] buttons to select Flow Units and press [√]. The following screen appears.

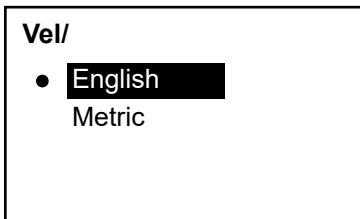


To check or change velocity flow units, in the User Pref/Flow Units menu, use the [Δ] or [▽] buttons to select Velocity and press [√]. The following screen appears.

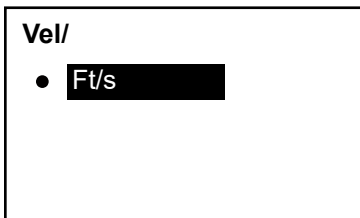
Note: If a flow unit is not selected in this menu, it will not appear later in the programming.



If you don't want display Velocity flow units, select No and press [√]. If you do want to display Velocity flow units, select Yes and press [√] twice. The following screen appears.

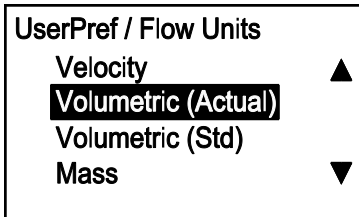


If no change is desired, press [x]. To change the units type, select the desired option and press [√]. A screen similar to the following appears.

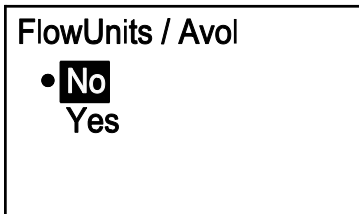


To confirm the selected units, press [x] three times and you will return to the UserPref/Flow Units menu.

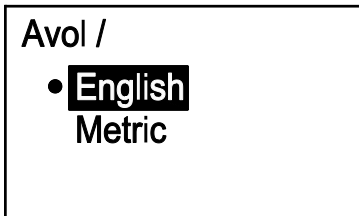
3.6.2b Volumetric and mass flow units



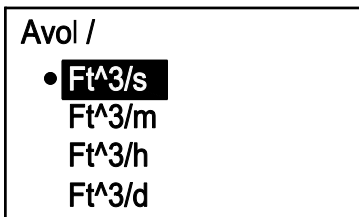
To check or change actual volumetric flow units, in the User Pref/Flow Units menu, use the [△] or [▽] buttons to select Volumetric (Actual) and press [✓]. The following screen appears.



If you don't want display Volumetric (Actual) flow units, select No and press [✓]. If you do want to display Volumetric (Actual) flow units, select Yes and press [✓] twice. The following screen appears.



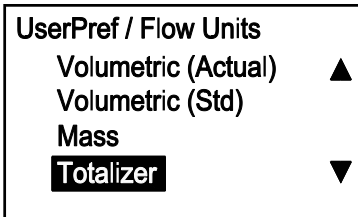
If no change is desired, press [x]. To change the units type, select the desired option and press [✓] twice. A screen similar to the following appears.



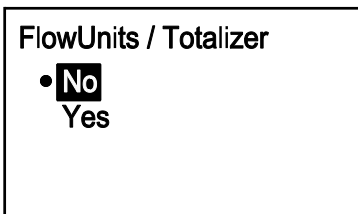
If the highlighted units are correct, press [x]. To change the units, use the [△] or [▽] buttons to select the desired option and press [✓] twice to return to the previous screen. Then, press the [x] key twice to return to the UserPref/Flow Units screen.

Repeat the above procedure to check or change the standard volumetric (Volumetric (Std)) flow units and mass (Mass) flow units, as required.

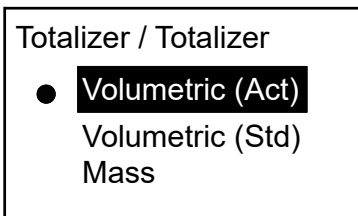
3.6.2c Totalizer flow units



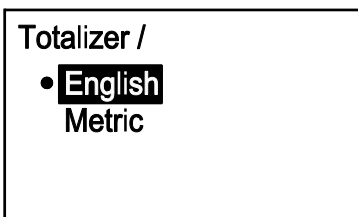
To check or change totalizer flow units, in the User Pref/Flow Units menu, use the [△] or [▽] buttons to select Totalizer and press [✓]. The following screen appears.



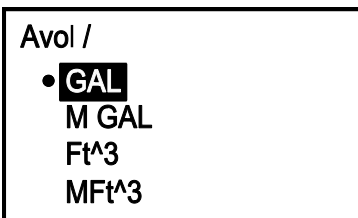
If you don't want display Totalizer flow units, select No and press [✓]. If you do want to display Totalizer flow units, select Yes and press [✓] twice. The following screen appears.



Use the [△] or [▽] buttons to select Volumetric (Act), Volumetric (Std) or Mass as the flow units to be totaled. Then, press [✓] twice and a screen similar to the following appears.

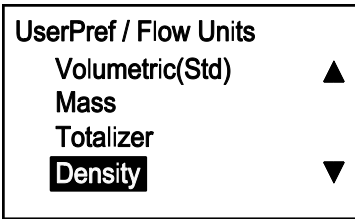


If no change is desired, press [x]. To change the units type, select the desired option and press [✓] twice. A screen similar to the following appears.

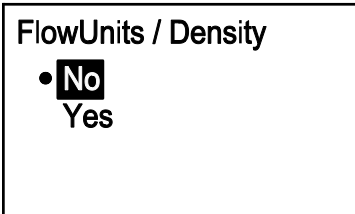


If the highlighted units are correct, press [x]. To change the units, use the [△] or [▽] buttons to select the desired option and press [✓] twice to return to the previous screen. Then, press the [x] key twice to return to the UserPref/Flow Units screen.

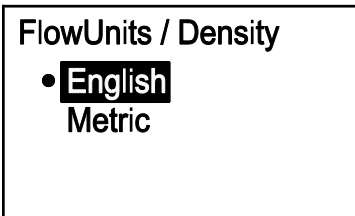
3.6.2d Density flow units



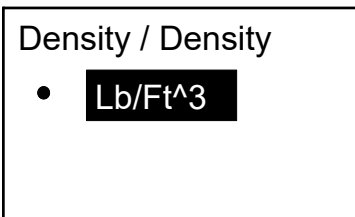
To calculate Mass flow, you must enter Actual Density. To measure Volumetric (Std) flow, you must enter both Actual Density and the Reference Density. To check or change density values in the \ UserPref/Flow Units menu, use the [△] or [▽] buttons to select Density and press [✓]. The following screen appears.



To exit the Totalizer setup procedure, use the [△] or [▽] buttons to select No and press [✓]. The screen returns to the previous display. To continue setting up the Totalizer, select Yes and press [✓]. A screen similar to the following appears.



If no change is desired, press [x]. To change the units type, select the desired option and press [✓] twice. A screen similar to the following appears.

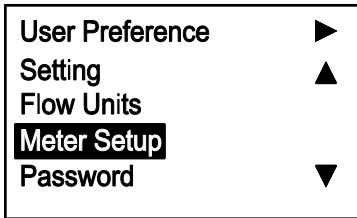


If the highlighted units are correct, press [x]. To change the units, use the [△] or [▽] buttons to select the desired option and press [✓] twice to return to the previous screen. Then, press the [x] key twice to return to the UserPref/Flow Units screen.

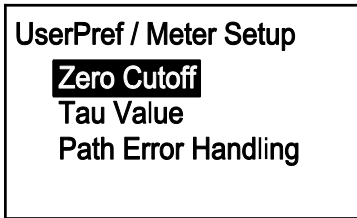
3.6.3 Meter setup

Note: Access to the Meter Setup menu requires either a SIL User, Service or Factory password.

3.6.3a Zero cutoff

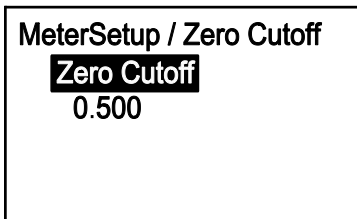


To set up the meter from the User Preference menu, use the [Δ] or [▽] buttons to select Meter Setup and press [✓]. The following screen appears.

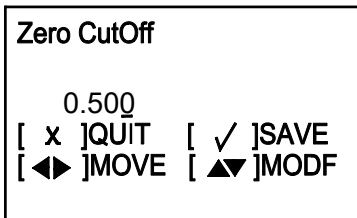


Select Zero Cutoff and press [✓]. A screen similar to the following appears.

Note: The Zero cutoff is based on the velocity measurement.



To set the zero cutoff, press [✓] and a screen similar to the following appears. When the flow velocity drops below the zero cutoff value, the flow reading will be forced to 0.00. This is to avoid continuous measurement fluctuations when the flow velocity is near the zero point.



Use the [◀] and [▶] buttons to select each digit to be changed and use the [Δ] or [▽] buttons to change the value of the highlighted digit. Then, press [✓] to confirm the value and press the [x] key to return to the Meter Setup screen.

3.6.3b Tau value

UserPref/Meter Setup

Zero Cutoff

Tau Value

Path Error Handling

The Tau value determines how quickly the meter responds to changes in flow rate. A small value results in fast responses, but the displayed flow value is very erratic. A high value dampens the response to flow rate changes for a smooth transition between displayed flow values, but response to changes is slower. In the Meter Setup menu, use the [Δ] or [▽] buttons to select Tau Value. Press [✓] and a screen similar to the following appears.

Note: The default Tau value is 0.001 sec (1 msec).

MeterSetup/Tau Value

Tau Value

0.04

To set the Tau value, press [✓] and a screen similar to the following appears.

Tau Value

0.04

[x]QUIT [✓]SAVE
[◀]MOVE [▶]MODF

Use the [◀] and [▶] buttons to select each digit to be changed and use the [Δ] or [▽] buttons to change the value of the highlighted digit. Then, press [✓] to confirm the value and press the [x] key to return to the Meter Setup screen.

UserPref/Meter Setup

Zero Cutoff

Tau Value

Path Error Handling

2-path Error Handling behaves differently in a SIL product than it does in non-SIL products. For a SIL product, 2-path Error Handling is only applicable to a three-path system (when available). If 2-path Error Handling is enabled for a 2-path flowmeter, it will have no effect. Refer to "Path Error Handling" on page 136 for details.

MeterSetup/Path Error Handling

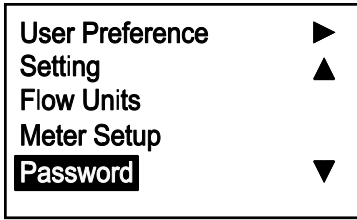
• **OFF**
ON

To turn the Path Err Handling ON or OFF, select the desired status and press [✓]. The screen returns to the previous display.

Note: The default for Path Error Handling is ON. For a complete explanation of path error handling, refer to "Path Error Handling" on page 136.

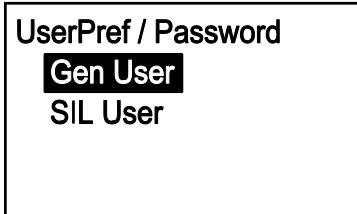
3.6.4 Password

3.6.4a General user



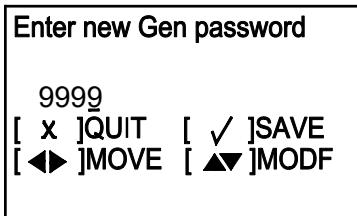
This menu is used to change the General User password. To set up a password, from the User Preference menu, use the [△] or [▽] buttons to select Password and press [✓]. The following screen appears.

Note: If a Gen User password was used to access this menu, the SIL User option is not available.



To set a general user password, select Gen User and press [✓]. A screen similar to the following appears.

Note: If a Gen User password was used to access this menu, the SIL User option is not available. However, a SIL user can reset the Gen User password.



Use the [◀] and [▶] buttons to select each digit to be changed and use the [△] or [▽] buttons to change the value of the highlighted digit. Then, press [✓] to confirm the value and press the [x] key to return to the Meter Setup screen.

3.6.4b SIL user

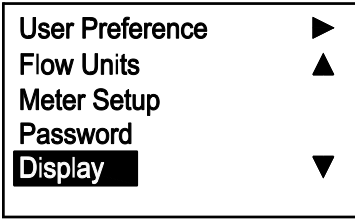
Follow the procedure in the previous section to change a SIL User password from its default setting. Note: If a Gen User password was used to access this menu, the SIL User option is not available.

IMPORTANT:

If the SIL User password is lost, a Panametrics service engineer must reset the password.

3.6.5 Display

3.6.5a Backlight



This menu is used to change the General User password. To set up a password, from the User Preference menu, use the [△] or [▽] buttons to select Password and press [✓]. The following screen appears.

Note: If a Gen User password was used to access this menu, the SIL User option is not available.



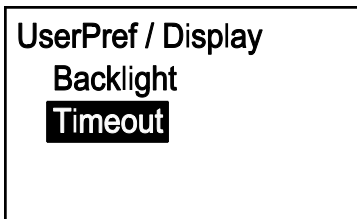
To set a general user password, select Gen User and press [✓]. A screen similar to the following appears.

Note: If a Gen User password was used to access this menu, the SIL User option is not available. However, a SIL user can reset the Gen User password.



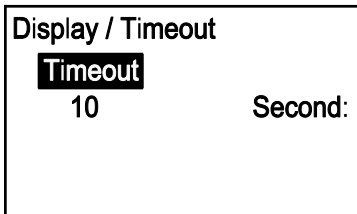
Use the[<] and [>] buttons to select each digit to be changed and use the [△] or [▽] buttons to change the value of the highlighted digit. Then, press [✓] to confirm the value and press the [x] key to return to the Meter Setup screen.

3.6.5b Timeout

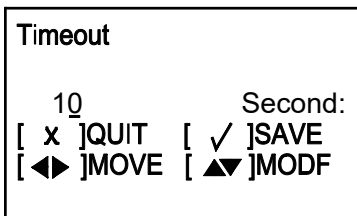


To provide a timeout value from the Display menu, select Timeout and press [✓]. A screen similar to the following appears.

Note: The default value for the timeout is 0, so users must set a timeout if they wish one.



Press [✓] again and a screen similar to the following appears.

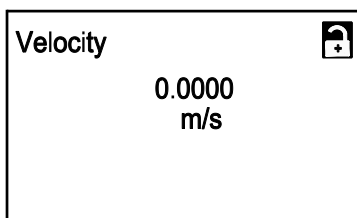


Use the [◀] and [▶] buttons to select each digit to be changed and use the [△] or [▽] buttons to change the value of the highlighted digit. Then, press [✓] to confirm the value and press the [x] key three times to return to the User Preference screen.

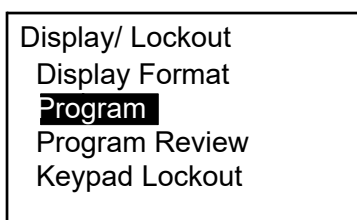
3.7 Input/output setup

3.7.1 Analog output A (SIL)

3.7.1a Accessing the analog output menu



To access the Analog Outputs menu from the display screen, highlight the lock symbol and press [✓]. The following screen appears.



Select Program and press [✓]. The following screen appears.

3.7.1a Accessing the analog output menu (cont.)

```
Lockout / Programming
  Gen User
  • SIL User
  Services
  Factory
```

Select a password level (SIL User, Service or Factory) other than General User from the Program Menu and press Enter. The following screen appears.

```
Enter SIL Password
  9999
 [ x ]QUIT [ ✓ ]SAVE
 [ ◀ ]MOVE [ ▲ ]MODF
```

To enter the SIL password, use the [◀] and [▶] buttons to select each digit and use the [△] or [▽] buttons to change the value of the highlighted digit. Then, press [✓] and the following screen appears.

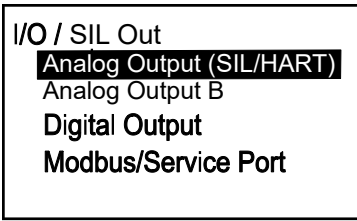
```
User Preference ▶
 Setting ▲
 Flow Units
 Meter Setup
 Password ▼
```

In the User Preference menu, select Setting then press the [x] button. A screen similar to the following appears.

```
◀ I/O ▶
 • Option A
```

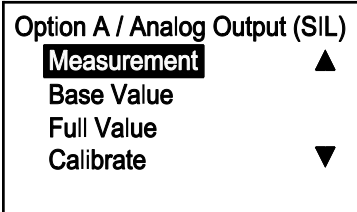
With Option A highlighted, press [✓]. The following screen appears.

3.7.1b Setting analog measurement type

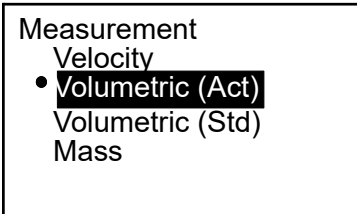


To set up the SIL analog output, select Analog Output (SIL/HART) and press [✓]. The following screen appears.

Note: If a Gen User password was used to access this menu, the Analog Output (SIL/HART) option is not available.



Select Measurement and press [✓]. The following screen appears.



In the Measurement menu, select the type of analog output to be used, and press [✓]. The screen returns to the previous display.

3.7.1c Setting the base value and the full value

Option A / Analog Output (SIL)
Measurement ▲
Base Value
Full Value
Calibrate ▼

Base Value is the flow rate represented by a 4 mA analog output and Full Value is the flow rate represented by a 20 mA analog output.

In the Analog Output menu, select Base Value and press [✓]. A screen similar to the following appears.

Analog Output (SIL) / Base
Base Value
0.00000 m³/s

Press [✓] again and a screen similar to the following appears.

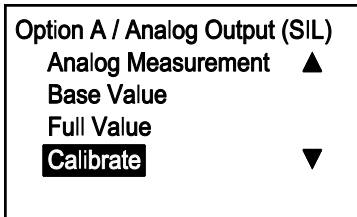
Note: The units that appear are the units selected in “Flow Units” on page 43.

Base Value
0.00000 m³/s
[x]QUIT [✓]SAVE
[◀]MOVE [▶]MODF

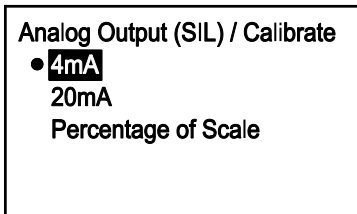
To change the Base Value setting, use the [◀] and [▶] buttons to select each digit and use the [△] or [▽] buttons to change the value of the highlighted digit. Then, press [✓] and the following screen appears.

Repeat these steps to program the Full Value setting. Then, press [x] to return to the Analog Output menu.

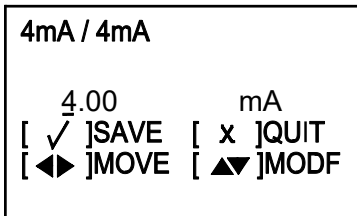
3.7.1d Selecting the calibration value



Use the Calibrate menu to trim the SIL output to your measurement system. Select 4 mA to trim the 4 mA level, 20 mA to trim the 20 mA level, or Percentage of Scale to test linearity. In the Analog Output (SIL) menu, select Calibrate and press [✓]. The following screen appears.



Select the desired option and press [✓]. A screen similar to the following appears.

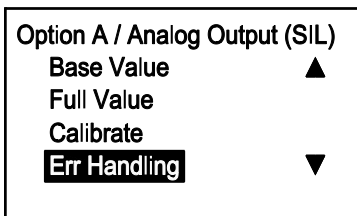


Use the [△] or [▽] button to change the Calibrate setting value and press [✓]. Then, press [x] to return to the Analog Output menu.

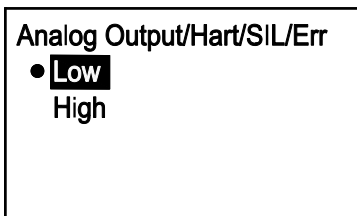
If the analog output of your measurement system is not 4.00 mA, enter the actual value. Then, press [✓] and the meter will make an adjustment. Repeat the process until you do have a 4.00 mA output.

Repeat the above process until all desired options in this menu have been calibrated.

3.7.1e Setting the error handling



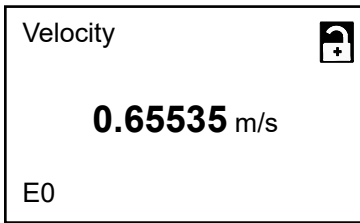
To specify the error handling setting in the Analog Output menu, select Err Handling and press [✓]. The following screen appears.



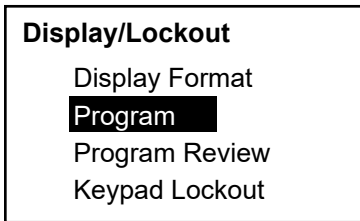
Select Low to force the SIL Output to 3.6 mA or below in case of a SIL error, or select High to force it to 21.0 mA or above in case of a SIL error. After making your selection, press [✓].

3.7.2 Analog output B (Non-SIL)

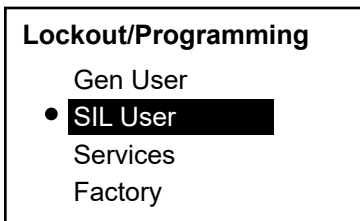
3.7.2a Accessing the analog output menu



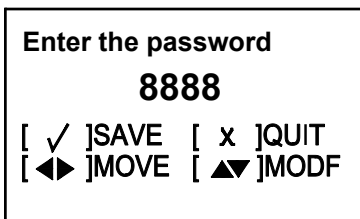
To access the Analog Outputs menu from the display screen, highlight the lock symbol and press [✓]. The following screen appears.



Select Program and press [✓]. The following screen appears.

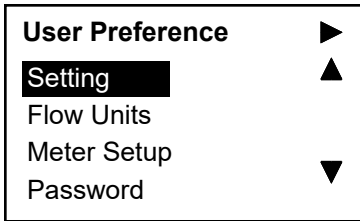


Select any password level (Gen User, SIL User, Services or Factory) from the Program Menu and press Enter. The following screen appears.

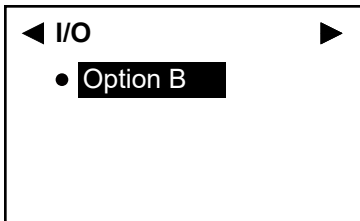


To enter the password, use the [◀] and [▶] buttons to select each digit and use the [△] or [▽] buttons to change the value of the highlighted digit. Then, press [✓] and the following screen appears.

3.7.2a Accessing the analog output menu (cont.)

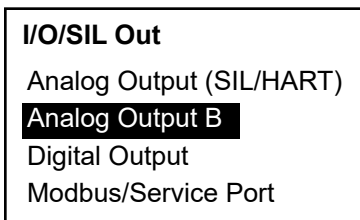


In the User Preference menu, select Setting then press the [▷] button. A screen similar to the following appears.



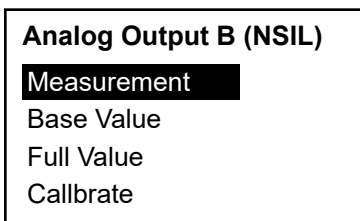
With Option B highlighted, press [√]. The following screen appears.

3.7.2b Setting the analog measurement type

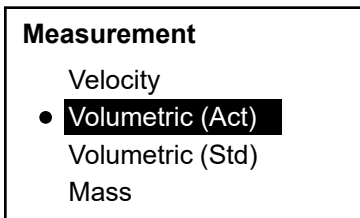


To set up the Non-SIL analog output, select Analog Output B and press [√]. The following screen appears.

Note: If a Gen User password was used to access this menu, the Analog Output (SIL/HART) option is not available.

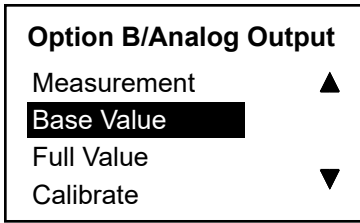


Select Measurement and press [√]. The following screen appears.



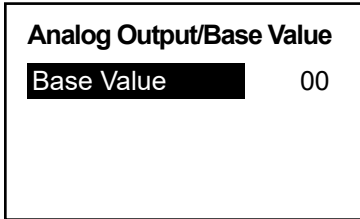
In the Measurement menu, select the type of analog output to be used, and press [√]. The screen returns to the previous display.

3.7.2c Setting the base value and the full value



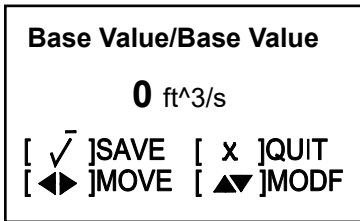
Base Value is the flow rate represented by a 4 mA analog output and Full Value is the flow rate represented by a 20 mA analog output.

In the Analog Output menu, select Base Value and press [✓]. A screen similar to the following appears.



Press [✓] again and a screen similar to the following appears.

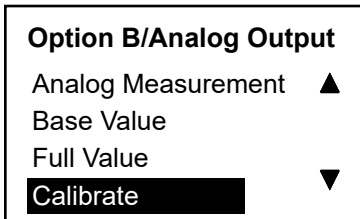
Note: The units that appear are the units selected in “Flow Units” on page 43.



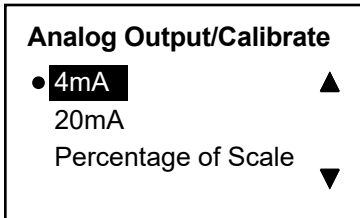
To change the Base Value setting, use the [◀] and [▶] buttons to select each digit and use the [▲] or [▼] buttons to change the value of the highlighted digit. Then, press [✓] and the following screen appears.

Repeat these steps to program the Full Value setting. Then, press [x] to return to the Analog Output menu.

3.7.2d Selecting the calibration value

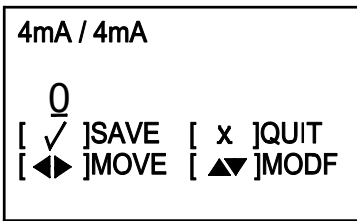


Use the Calibrate menu to trim the Non-SIL output to your measurement system. Select 4 mA to trim the 4 mA level, 20 mA to trim the 20 mA level, or Percentage of Scale to test linearity. In the Analog Output menu, select Calibrate and press [✓]. The following screen appears.



Select the desired option and press [✓]. A screen similar to the following appears.

3.7.2d Selecting the calibration value (cont.)

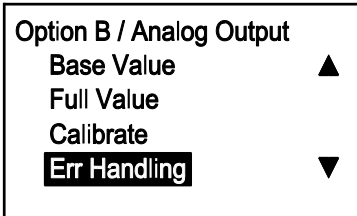


Use the [Δ] or [▽] button to change the Calibrate setting value and press [✓]. Then, press [x] to return to the Analog Output menu.

If the analog output of your measurement system is not 4.00 mA, enter the actual value. Then, press [✓] and the meter will make an adjustment. Repeat the process until you do have a 4.00 mA output.

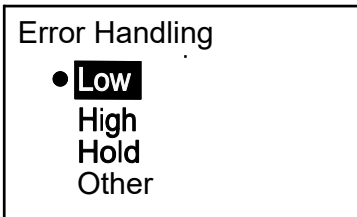
Repeat the above process until all desired options in this menu have been calibrated.

3.7.2e Setting the error handling

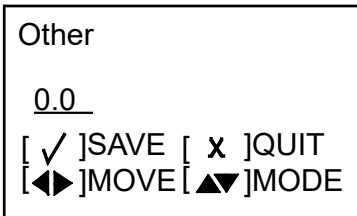


To specify the error handling setting in the Analog Output menu, select Err Handling and press [✓]. The following screen appears.

Note: An "Error" condition is any condition that produces an error code on the display screen. See Chapter 4 for more details on errors.



To set the response of Output B to an error condition, select: Low to force an output of 4.0 mA, High to force an output of 20.0 mA, or Hold to keep the current reading at the time of the error. Selecting Other allows the operator to select a mA value to represent a fault condition, such as Namur error levels or another custom value. After making your selection, press [✓].



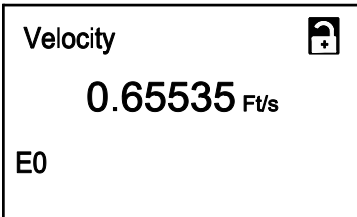
If you select Other, use the [Δ] or [▽] buttons to change the Other setting value and press [✓]. Then, press [x] to return to the Analog Output menu.

3.7.3 Programming the digital outputs

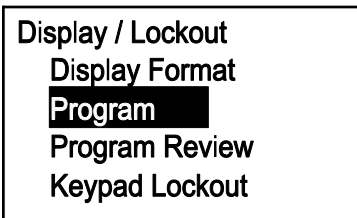
Digital Outputs are output circuits that are designed to be used as Pulse Outputs, Frequency Outputs, Alarms, or Control Outputs. They have a flexible circuit design that can be programmed to perform a variety of functions. The sections that follow describe how to set up each type of function.

Note: For each available function, the behavior of the system during an Error condition can be programmed. Chapter 4 describes several types of possible Error conditions for the flowmeter. It may not always be clear which errors will trigger the Error Handling function, but as a general rule the error handling function will be active whenever an error message appears on the LCD display screen.

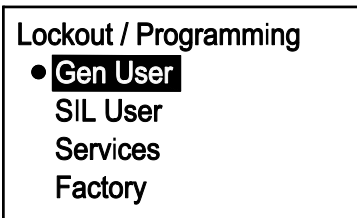
3.7.3a Accessing the digital output menu



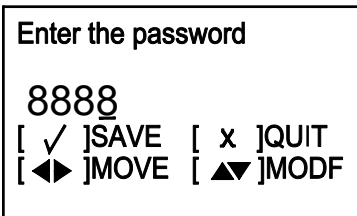
To access the Digital Outputs menu from the display screen, highlight the lock symbol and press [✓]. The following screen appears.



Select Program and press [✓]. The following screen appears.

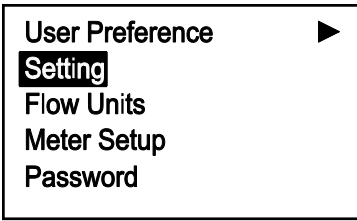


Select any password level (Gen User, SIL User, Services or Factory) from the Program Menu and press Enter. The following screen appears.

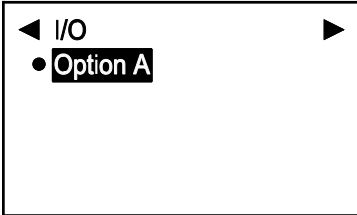


To enter the password, use the [◀] and [▶] buttons to select each digit and use the [△] or [x] buttons to change the value of the highlighted digit. Then, press [✓] and the following screen appears.

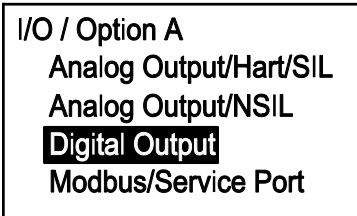
3.7.3a Accessing the digital output menu (cont.)



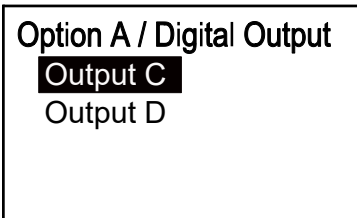
In the User Preference menu, select Setting then press the [▷] button. A screen similar to the following appears.



With Option A highlighted, press [√]. The following screen appears.

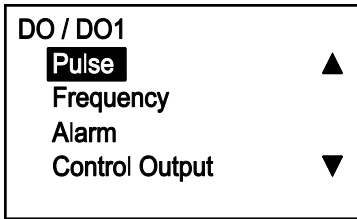


To set up the Digital Output, select it from the list shown on the screen and press [√]. A screen similar to the following appears.

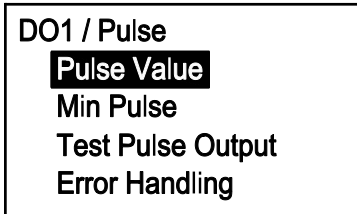


Select the desired Digital Output label (C or D) and press [√]. The following screen appears.

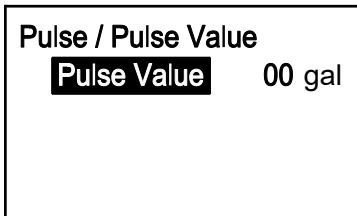
3.7.3b Setting the pulse output



The Digital Outputs can be programmed as Pulse, Frequency, Alarm or Control Output, or they may be turned Off. To set the Pulse output, which is a square wave pulse for each unit of flow that passes through the pipeline, select Pulse and press [✓]. The following screen appears.

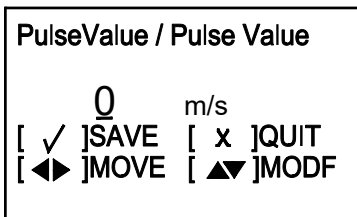


Select Pulse Value and press [✓]. A screen similar to the following appears.

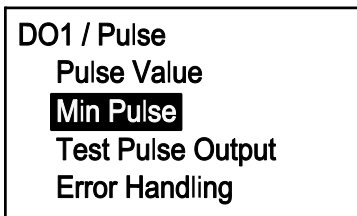


The Pulse Value, which is the amount of flow represented by one pulse (e.g., 1 pulse = 10 gallons), is displayed on the screen. To change the current setting, press [✓] and a screen similar to the following appears.

Note: The units that appear will be the units selected in “Flow Units” on page 43.



To change the Pulse Value, use the [◀] and [▶] buttons to select each digit and use the [△] or [▽] buttons to change the value of the highlighted digit. Press [✓] to save, and then press [x] to return to the Pulse menu.

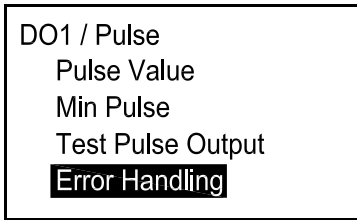


To view or change another Pulse parameter, select the desired parameter on the list and proceed as follows:

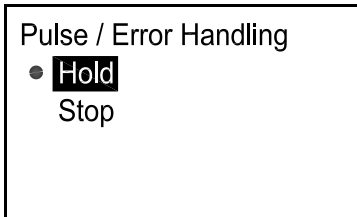
- To enter the Minimum Pulse ON Time (Min Pulse), set the desired width of the pulse in seconds.
- To Test Pulse Output, enter the desired number of pulses and verify that the specified number of pulses were received by the measurement system.
- If Error Handling is selected, a different procedure is required. See the next page for instructions.

3.7.3b Setting the pulse output (cont.)

Proceed with the following steps only if you wish to modify the Error Handling setting.

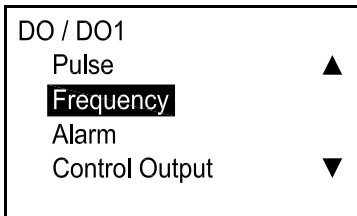


To change the current setting, select Error Handling on the screen and press [✓]. The following screen appears.

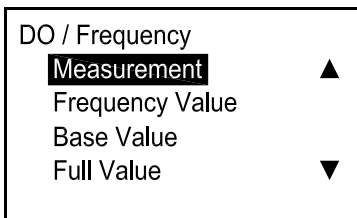


Select Hold if you want the meter to keep sending pulses at the last good reading after a flow measurement error occurs, or select Stop if you want the meter to stop sending pulses after a flow measurement error occurs. After making your selection, press [✓] and the screen returns to the previous display. Then, press [x] to return to the Digital Output Menu.

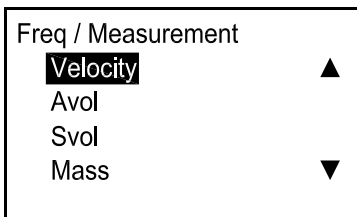
3.7.3c Setting the frequency output



The Frequency output transmits a continuous square wave with a frequency proportional to the measured value. To set the Digital Output as a frequency output, in the Digital Output Menu select Frequency and press [✓]. The following screen appears.



To set the measurement type, select Measurement and press [✓]. The following screen appears.



Select the desired measurement parameter and press [✓]. The screen returns to the Frequency display.

Note: Examples of pulse and frequency outputs are shown on the next page.

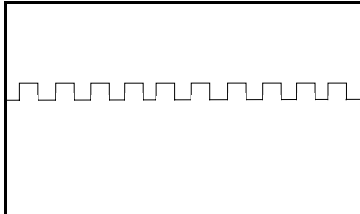
3.7.3c Setting the frequency output (cont.)



Example 1 (Pulse Output):

Base Value: 0 m/s = 0 Hz Full Value: 10 m/s = 100 Hz

$$\text{Then, } y \text{ (Hz)} \times (\text{m/s}) \times \frac{100 \text{ Hz}}{10 (\text{m/s})} = 10x \text{ (Hz)}$$

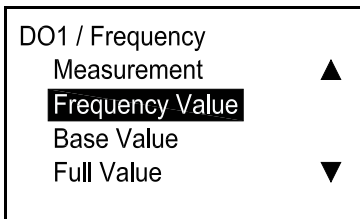


Example 2 (Frequency Output):

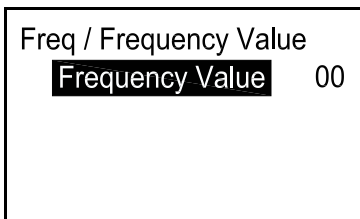
Base Value: 10 kg = 0 Hz

Full Value: 20 kg = 10 Hz

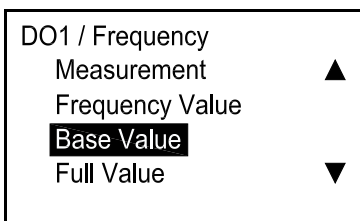
$$\text{Then, } y \text{ (Hz)} \times (\text{kg} - 10) \times \frac{10 \text{ Hz} - 0 \text{ Hz}}{20 \text{ kg} - 10 \text{ kg}} = (x-10) \text{ Hz}$$



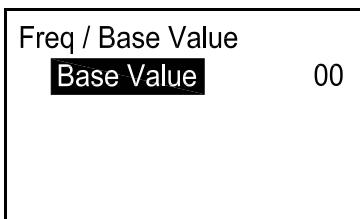
To check the current frequency value, on the Frequency display select Frequency Value and press [✓]. A screen similar to the following appears.



To change the current value, press [✓] and proceed as in "Setting the Pulse Output" on page 62.



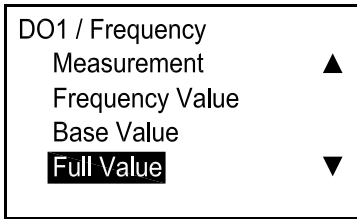
The Base Value is the measurement value represented by 0 Hz. To check the current base value, on the Frequency display select Base Value and press [✓]. A screen similar to the following appears.



To change the current value, press [✓] and proceed as in "Setting the Pulse Output" on page 62.

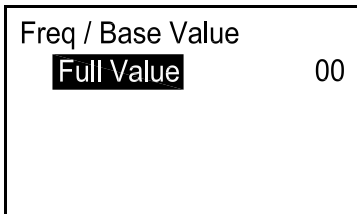
Note: The units that appear will be the units selected in "Flow Units" on

3.7.3c Setting the frequency output (cont.)

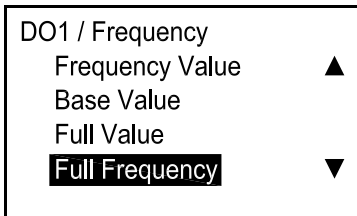


The Full Value is the measurement value represented by the full frequency. To check the current full value, on the Frequency display select Full Value and press [✓]. A screen similar to the following appears.

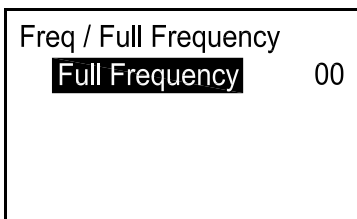
Note: The units that appear will be the units selected in "Flow Units" on page 43.



To change the current value, press [✓] and proceed as in "Setting the Pulse Output" on page 62.

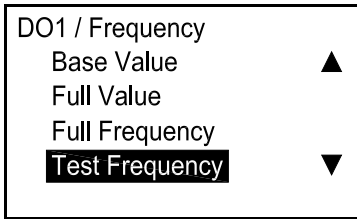


The Full Frequency is the maximum Hz, which represents the maximum measurement value. To check the current full frequency, on the Frequency display select Full Frequency and press [✓]. A screen similar to the following appears.

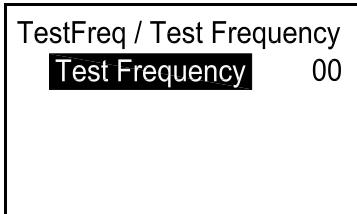


To change the current full frequency value, press [✓] and proceed as in "Setting the Pulse Output" on page 62.

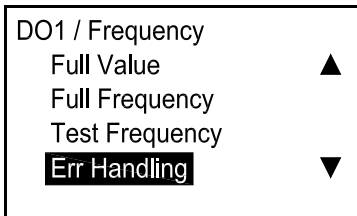
3.7.3c Setting the frequency output (cont.)



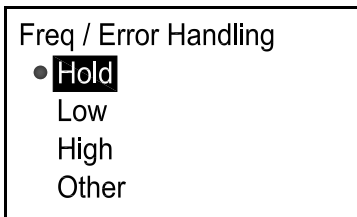
To check the frequency function, on the Frequency display select Test Frequency and press [✓]. A screen similar to the following appears.



To set a test frequency, press [✓] and enter the desired Hz value. The meter will set the digital output to this value. Then, verify that your measurement system is receiving the same frequency that you entered. You can repeat this procedure with several different test frequencies.

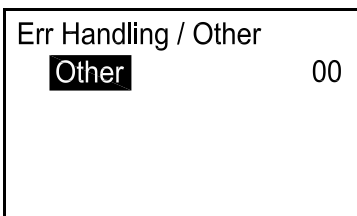


To specify the error handling setting in the Frequency menu, select Err Handling and press [✓]. The following screen appears.
An "Error" condition is any condition that produces an error code on the display screen. See Chapter 4 for more details on errors.



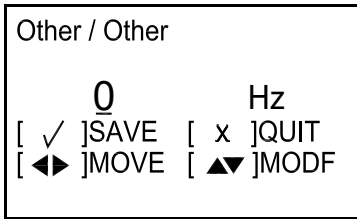
To set the response of the digital output to an error condition, select: Low to force an output of 0 Hz, High to force an output equal to the full frequency, or Hold to keep the last good reading. Selecting Other allows the operator to select a custom frequency value to represent a fault condition. After making your selection, press [✓].

Note: The following two screens appear only if you selected Other above.



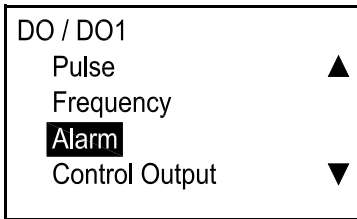
Enter the Hz value you want to appear in response to an error condition. For example, if Full Frequency = 1 kHz, you may want to set the error value to 2 kHz. Press [✓] and a screen similar to the following appears.

3.7.3c Setting the frequency output (cont.)

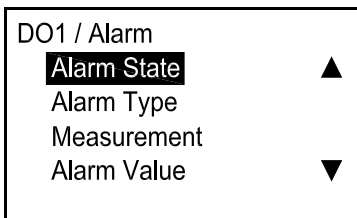


Use the [△] or [▽] buttons to change the Other value and press [✓] to save the number. Press [x] to return to the previous screen.

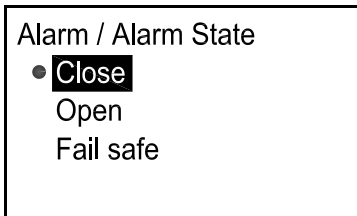
3.7.3d Setting the alarm outputs



The alarm contacts can be in either an open circuit state or a short circuit state, depending on the error condition. To check the alarm or change its settings, in the Digital Output menu select Alarm and press [✓]. The following screen appears.



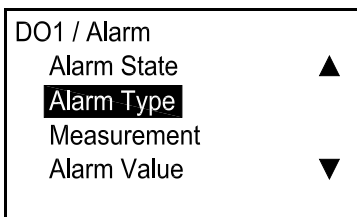
To check or change the alarm status, select Alarm State and press [✓]. A screen similar to the following appears.



Three alarm states are available:

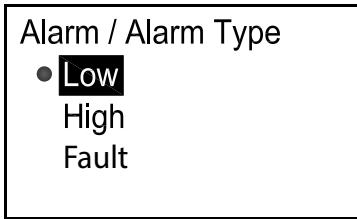
- Close: normally-closed contacts open during error condition
- Open: normally-open contacts close during error condition
- Fail Safe: alarm trips during error condition or power failure

To change the state of the alarm, select the desired status and press [✓]. The screen returns to the previous display.



To check or change the type of alarm, select Alarm Type and press [✓]. A screen similar to the following appears.

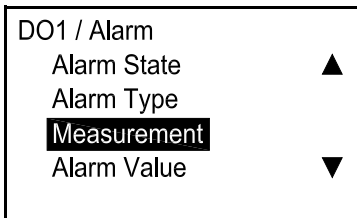
3.7.3d Setting the alarm outputs (cont.)



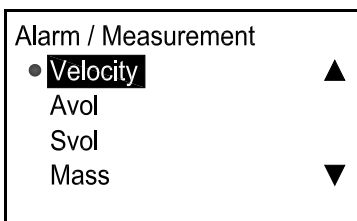
Three alarm types are available:

- Low: No alarm if measurement is greater than the setpoint, alarm if measurement is less than or equal to the setpoint.
- High: No alarm if measurement is less than the setpoint, alarm if measurement is greater than or equal to the setpoint.
- Fault: No alarm if no errors, alarm if errors.

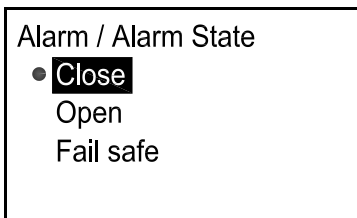
To change the state of the alarm, select the desired type and press [✓]. The screen returns to the previous display



To check or change the alarm measurement parameter, select Measurement and press [✓]. A screen similar to the following appears.



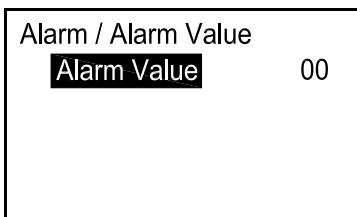
Select the desired measurement parameter, then press [✓] to return to the previous screen.



Three alarm states are available:

- Close: normally-closed contacts open during error condition
- Open: normally-open contacts close during error condition
- Fail Safe: alarm trips during error condition or power failure

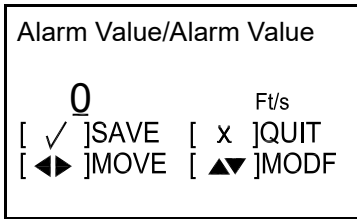
To change the state of the alarm, select the desired status and press [✓]. The screen returns to the previous display.



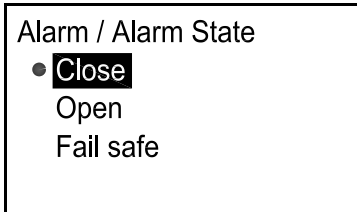
Press [✓] again, and a screen similar to the following appears.

Note: The units that appear will be the units selected in "Flow Units" on page 43.

3.7.3d Setting the alarm outputs (cont.)



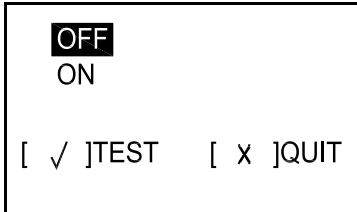
Use the [Δ] or [▽] buttons to change the Alarm Value setting. Then, press [√] to save the value and press [x] to return to the previous screen.



Three alarm states are available:

- Close: normally-closed contacts open during error condition
- Open: normally-open contacts close during error condition
- Fail Safe: alarm trips during error condition or power failure

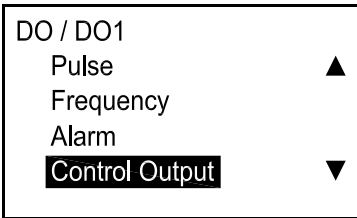
To change the state of the alarm, select the desired status and press [√]. The screen returns to the previous display.



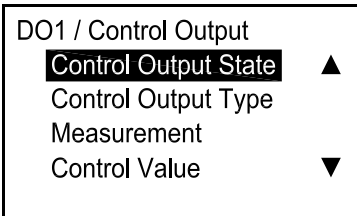
Select OFF to turn the alarm off, or ON to turn it on. To begin testing, select ON and press [√]. To stop testing, press [x].

IMPORTANT: Be sure to select OFF when you have finished the test.

3.7.3e Setting the control output

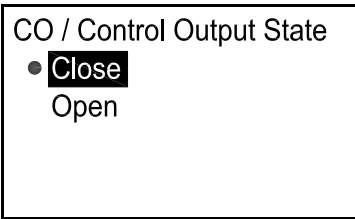


The Control Output can be used to drive an actuator that controls a process. The output is deactivated until a programmed threshold is reached, and it activates when that threshold is reached. To check the control output or change its settings, in the Digital Output menu select Control Output and press [√]. The following screen appears.

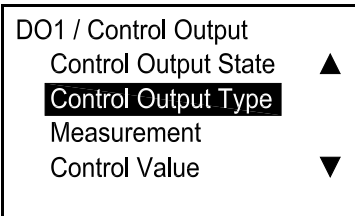


To check or change the control output status, select Control Output State and press [√]. A screen similar to the following appears.

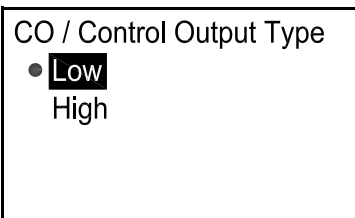
3.7.3e Setting the control output (cont.)



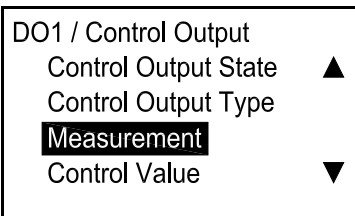
The Close output option is 0 V when deactivated and 3.3 V when activated. The Open output option is 3.3 V when deactivated and 0 V when activated. To change the state of the control output, select the desired status and press [✓]. The screen returns to the previous display.



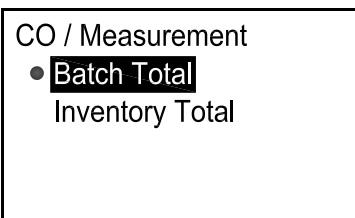
To check or change the type of control output, in the Control Output menu, select Control Output Type and press [✓]. The following screen appears.



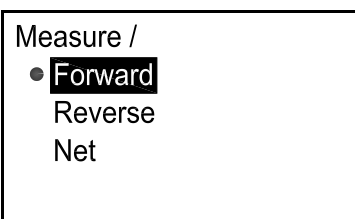
The Low control output activates when the measurement is less than or equal to a threshold value. The High control output activates when the measurement is greater than or equal to a threshold value. Low is useful for draining applications, and High is useful for filling applications. To change the type of control output, select the desired type and press [✓]. The screen returns to the previous display.



To check or change the measurement setup from the Control Output menu, select Measurement and press [✓]. The following screen appears.

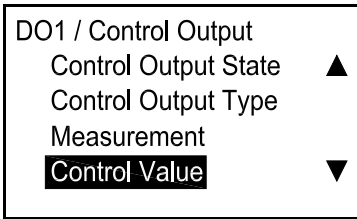


Press [✓] again, and a screen similar to the following appears. Batch Total supports fill and reset operations. The Inventory Total activates after a user-specified number of kg of usage (e.g., at 1000 kg, then 2000 kg, etc.). To change the measurement style, select the desired style and press [✓]. The following screen appears.

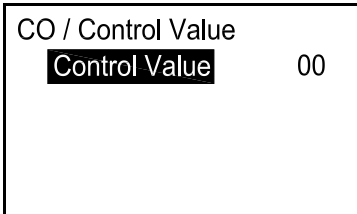


Select Forward or Reverse totalizer, depending on the flow direction, or select Net for both filling and draining. To change the measurement direction, select the desired option and press [✓]. The screen returns to the previous display.

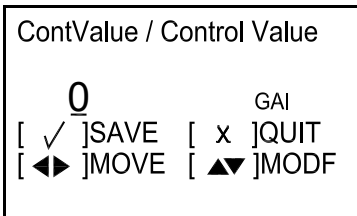
3.7.3e Setting the control output (cont.)



To check or change the control value from the Control Output menu, select Control Value and press [✓]. A screen similar to the following appears.

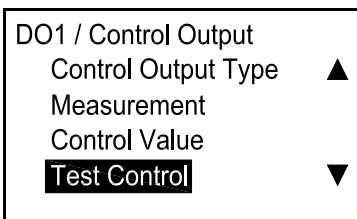


Press [✓] again, and a screen similar to the following displays the current threshold value used to activate the output.



Use the [△] or [▽] buttons to change the Control Value setting. Press [✓] to save the value and press [x] to return to the previous screen.

Note: The units that appear will be the units selected in “Flow Units” on page 43.



To test the actuator from the Control Output menu, select Test Control and press [✓]. A screen similar to the following appears.

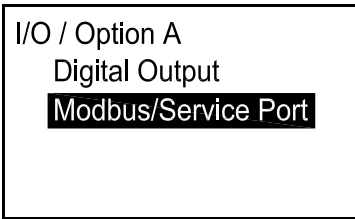


To begin testing, select ON and press [✓]. To stop testing, select OFF and press [✓]. Press [x] to return to the Control Output menu.

IMPORTANT:

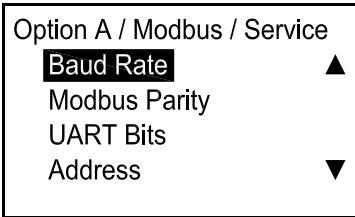
Be sure to select OFF when you have finished the test.

3.7.4 Modbus/service port A

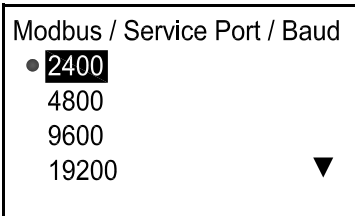


To set up the Modbus/Service Port, select it on the Option A screen and press [✓]. The following screen appears.

3.7.4a Selecting the baud rate

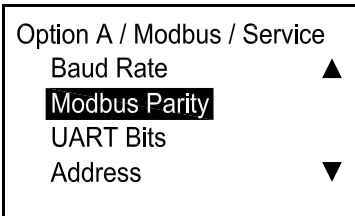


To set the Modbus baud rate from the Modbus/Service menu, select Baud Rate and press [✓]. A screen similar to the following appears.

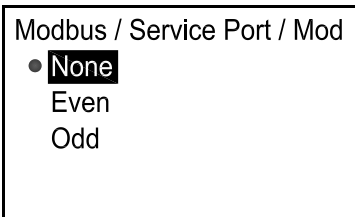


The default Modbus baud rate is 115200. To change the default value, select the desired baud rate and press [✓]. The screen returns to the previous display.

3.7.4b Setting the modbus parity

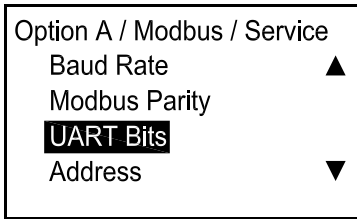


To set the Modbus parity from the Modbus/Service menu, select Modbus Parity and press [✓]. A screen similar to the following appears.

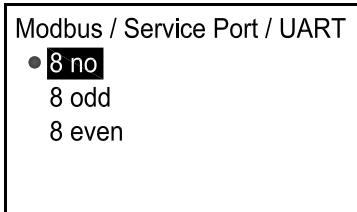


The default Modbus parity setting is None. To change the default setting, select the desired parity setting and press [✓]. The screen returns to the previous display.

3.7.4c Selecting the UART bits

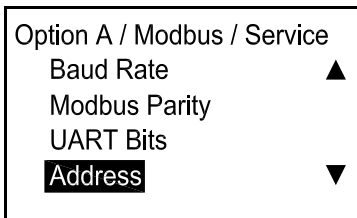


To set the UART bits from the Modbus/Service menu, select UART Bits and press [✓]. A screen similar to the following appears.

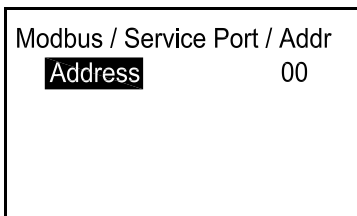


Select the desired UART bits setting and press [✓]. The screen returns to the previous display.

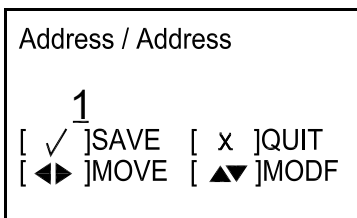
3.7.4d Setting the modbus/service port address



To set the Modbus Address from the Modbus/Service menu, select Address and press [✓]. A screen similar to the following appears.

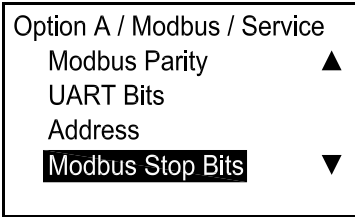


Press [✓] again, and a screen similar to the following appears.

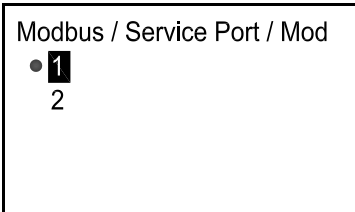


Use the [▲] or [▼] buttons to change the Modbus address to a number from 1 to 254 (note that 0 is not an acceptable number), and press [✓]. Then, press [x] to return to the previous screen.

3.7.4e Setting the number of modbus stop bits



To set the number of Modbus stop bits from the Modbus/Service menu ,select Modbus Stop Bits and press [✓]. A screen similar to the following appears.

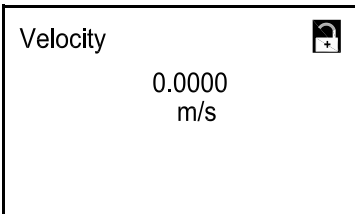


Select the desired number of Modbus Stop Bits (1 or 2) and press [✓]. The screen returns to the previous display.

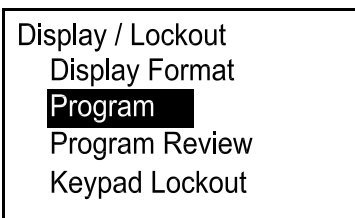
3.8 SIL testing

Note: To enter the SIL Testing menu, you must enter a SIL User, Service or Factory password.

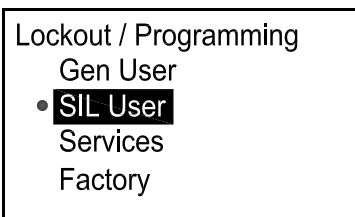
3.8.1 Accessing the SIL testing menu



To access the Analog Output menu from the measurement display screen, highlight the lock symbol and press [✓]. The following screen appears.



Select Program and press [✓]. The following screen appears.



Select a password level (SIL User, Service or Factory) other than General User from the Program Menu and press Enter. The following screen appears.

3.8.1 Accessing the SIL testing menu (cont.)

```
Enter SIL Password
9999
[ x ]QUIT [ ✓ ]SAVE
[ ◀ ]MOVE [ ▶ ]MODF
```

To enter the password, use the [◀] and [▶] buttons to select the digit to be changed, use the [△] or [▽] buttons to change the value of each digit, and then press [✓] when done. The following screen appears.

```
User Preference ▶
Setting ▲
Flow Units
Meter Setup
Password ▼
```

Select Setting in the User Preference menu, then press the [▶] button twice. A screen similar to the following appears.

```
◀ SIL Testing
SIL Output Min/Max
SIL Output Analog Switch
On Board Temperature
Watchdog Test
```

The screen shows the four available menu options. Select SIL Output Min/Max and press [✓]. The following screen appears.

3.8.2 Testing the min/max output

```
SIL Output Min/Max
Fire Low
Fire High
● Percentage of Scale
```

To test the SIL Output, use the [△] or [▽] buttons to select Fire Low to test the minimum output setting, Fire High to test the maximum output setting or Percentage of Scale to test any other output value, and press [✓]. If you select Percentage of Scale, the following screen appears.

```
Percentage of Scale
UNIT: %
0.00
[ ✓ ]SAVE [ x ]QUIT
[ ◀ ]MOVE [ ▶ ]MODF
```

To enter the desired percentage, use the [◀] and [▶] buttons to select the digit to be changed, use the [△] or [▽] buttons to change the value of each digit, and press [✓] when done. Then, press [x] to return to the SIL Testing menu.

3.8.3 Testing the output analog switch

SIL Output Analog Switch

- Open Switch
- **Close Switch**

From the SIL Testing menu, select SIL Output Analog Switch and press [✓]. Use the [△] or [▽] buttons to select Open Switch or Close Switch, and press [✓] when done. Then, press [X] to return to the SIL Testing menu.

Note: See the Safety Manual for more information.

3.8.4 Viewing the on board temperature

On Board Temperature

28.75 C

To check the electronics temperature, select On Board Temperature and press [✓]. The screen displays the current temperature.

See the Safety Manual for more information.

3.8.5 Performing a watchdog test



CAUTION!

The Watchdog Test will reset the flowmeter and discard any program parameter changes. Do not execute this test if you have changed your parameter settings.

Watchdog Test

- **No**
- Yes

To conduct a Watchdog Test, select Watchdog Test and press [✓]. Use the [△] or [▽] buttons to select Yes and press [✓]. The program runs the Watchdog Test and displays the results on the screen. Then, press [✓] to return to the measurement display screen.

See the Safety Manual for more information.

Chapter 4. Error codes and troubleshooting

4.1 User restrictions

If a Dangerous Detected state occurs, the flowmeter will put the SIL Output in the DD state and remain that way until an Authorized User intervenes. The DD state can be cleared by executing a reset of the flowmeter. There are two methods for clearing the DD state:

- Enter the Program menu at SIL user access level, then exit without making any changes. The flowmeter will execute a soft reset.

or

- Turn the power off and wait for one minute. Then, turn the power back on.

4.2 Error display in the user interface

The bottom line of the LCD displays a single, top priority error message during Measurement Mode. This line, called the Error Line, includes two parts: Error header and Error String. The Error header indicates the error pattern and error number, while the Error string gives a detailed description of the error information

4.2.1 Error header

Error Pattern	Error Header
Communication error	Cn (n is error number)
Flow error	En (n is error number)
SIL error	Sn (n is error number)
XMIT error	Xn (n is error number)
OPT error	On (n is error number)

Table 3: Error Header

4.2.2 Communication error string

The PanaFlow HT flowmeter electronics includes two independent sub-systems. The purpose of the Communication error string is to convey to the operator an issue with communication between these two sub-systems.

Error Header	Error Message
C1	UMPU Comm error

Table 4: Communication Error String



Figure 28: Communications Error String

4.2.3 Flow error string

Flow errors are errors detected by the UMPU (Ultrasonic Measurement Processing Unit) in the course of making a flow measurement. These errors can be caused by disturbances in the fluid, such as excessive particles in the flow stream or extreme temperature gradients. The errors could also be caused by an empty pipe or other such issue with the fluid itself. Flow errors are typically not caused by a malfunction of the flow measurement device, but by an issue with the fluid itself.

Error Header	Error Message	Explanation
E29	VelocityWarning	E29 indicates that the flow rate has exceeded the range of the LWL (lower warning limit) or UWL (upper warning limit). The purpose of this warning is to alert the operator that the flow rate is approaching the LFL (lower functional limit) or the UFL (upper functional limit). At the Warning Limit threshold, the flowmeter will continue to measure flow and drive the SIL output, but if the flow rate reaches the Functional Limit threshold the SIL output will go to the Dangerous Detected state until an Authorized User intervenes. E29 gives the operator a chance to correct the situation before going to the DD state.
E22	SingleChAccuracy	E22 indicates that an error was detected on one of the flow channels. This applies to multiple channel systems only. For example, there may be an issue in the channel 1 measurement but not the channel 2 measurement.
E23	MultiChAccuracy	E23 indicates an error on multiple channels.
E15	ActiveTw	E15 indicates an error with the active Tw measurement. This may be caused by a transducer error, a parameter programming error, or extreme process temperatures. The error means that the measurement of how long it is taking the ultrasonic signal to pass through the bundled waveguide is outside reasonable limits.

Table 5: Flow Error String

E6	CycleSkip	E6 indicates that a cycle skip has occurred in the signal processing measurement. This is usually due to poor signal integrity, possibly because of bubbles in the pipeline, sound absorption by very viscous fluids, or cavitation.
E5	Amplitude	E5 indicates an amplitude error in the signal processing measurement. The signal amplitude is either excessively high or low. This is also due to poor signal integrity, much like an E6 error.
E4	SignalQuality	E4 indicates a Signal Quality error. This means the signal shape, upstream to downstream reciprocity, or signal correlation value is poor. The cause is usually the same as E6 or E5.
E3	VelocityRange	E3 is a velocity range error, meaning that the calculated velocity is outside the velocity limits defined for this application. The velocity we are measuring is not reasonable for the fluid and pipe size programmed in the data set. This could be a programming error, a poor signal, or an actual flow condition that is unexpectedly high in the positive or negative direction.
E2	SoundSpeed	E2 is a sound speed error. One benefit of ultrasonic flow measurement is that the process can determine the sound speed of the fluid. If this sound speed is beyond the limits set for the programmed application, an E2 error is set. This can alert the operator that the wrong fluid is in the pipe, or that the program parameters are out of date. It may also occur if signal quality is poor.
E1	SNR	E1 indicates a low signal to noise ratio (SNR). This means the flowmeter is not getting very much acoustic signal from the process. This could be due to bubbles or other fluid conditions, an empty pipe, or other possible causes that are listed in the Diagnostics section.
E28	SIL	E28 is a SIL (Safety Integrity Level) error, which means we have a measurement condition that could lead to a false reading and we must stop providing a flow measurement to the SIL output. This will drive the SIL output to the DD state and stop providing flow readings to the SIS.
E31	NotCalibrated	E31 is an indication that the flowmeter has not been calibrated. This means we cannot be sure of flow measurement accuracy.

Table 5: Flow Error String (cont.)

Note: The flow errors listed in Table 5 above are listed in order of increasing priority. For troubleshooting tips, see “Diagnostics” on page 81.

4.2.4 SIL error string

Note: Few of these errors will appear on the LCD. The LCD only shows the top priority error at any time.

The Vitality software is able to list these error conditions in addition to the top priority error, because the PC display screen can show more information.

SIL errors are generally faults detected during internal device monitoring of the flow measurement circuitry. To ensure functional safety integrity, we must have absolute confidence in the integrity of our measurement hardware. These errors show that we do not have full confidence in some part of the hardware, and must stop providing a

measurement to the SIS. More details and corrective actions are listed in the Functional Safety Manual.

Under normal operation, only S1 - "In Config Mode" is likely to appear on the error line. This is an indication that the instrument is currently not measuring flow, because the instrument is in the Configuration mode. It also warns the Operator that the SIL Output is not to be used as part of the SIS while in this mode of operation.

For troubleshooting details and more information on S errors, consult the Safety Manual.

4.3 Diagnostics

4.3.1 Introduction

This section explains how to troubleshoot the PanaFlow HT if problems arise with the electronics enclosure, the flowcell, or the transducers. Indications of a possible problem include:

- Display of an error message on the LCD display screen, Vitality PC software, or HART.
- Erratic flow readings
- Readings of doubtful accuracy (i.e., readings which are not consistent with readings from another flow measuring device connected to the same process).

If any of the above conditions occurs, proceed with the instructions presented in this section.

4.3.2 Flowcell problems

If preliminary troubleshooting with the Error Code Messages and/or the Diagnostic Parameters indicates a possible flowcell problem, proceed with this section. Usually, flowcell problems are either fluid problems or pipe problems. Read the following sections carefully to determine if the problem is indeed related to the flowcell. If the instructions in this section fail to resolve the problem, contact Panametrics for assistance.

4.3.2a Fluid problems

Most fluid-related problems result from a failure to observe the flowmeter system installation instructions. Refer to Chapter 2, Installation, to correct any installation problems.

If the physical installation of the system meets the recommended specifications, it is possible that the fluid itself may be preventing accurate flow rate measurements. The fluid being measured must meet the following requirements:

- The fluid must be homogeneous, single-phase, relatively clean and flowing steadily. Although a low level of entrained particles may have little effect on the operation of the PanaFlow HT, excessive amounts of solid or gas particles will absorb or disperse the ultrasound signals. This interference with the ultrasound transmissions through the fluid will cause inaccurate flow rate measurements. In addition, temperature gradients in the fluid flow may result in erratic or inaccurate flow rate readings.
- The fluid must not cavitate near the flowcell. Fluids with a high vapor pressure may cavitate near or in the flowcell. This causes problems resulting from gas bubbles in the fluid. Cavitation can usually be controlled through proper installation design.
- The fluid must not excessively attenuate ultrasound signals. Some fluids, particularly those that are very viscous, readily absorb ultrasound energy. In such a case, an error code message will appear on the display screen to indicate that the ultrasonic signal strength is insufficient for reliable measurements.
- The fluid sound speed must not vary excessively. The PanaFlow HT will tolerate relatively large changes in the fluid sound speed, as may be caused by variations in fluid composition and/or temperature. However, such changes must occur slowly. Rapid fluctuations in the fluid sound speed, to a value that is considerably different from that programmed into the PanaFlow HT, will result in erratic or inaccurate flow rate readings. Refer to Chapter 3, Initial Setup and make sure that the appropriate sound speed is programmed into the meter.

4.3.2b Pipe problems

Pipe-related problems may result either from a failure to observe the installation instructions, as described in Chapter 2, or from improper programming of the meter. By far, the most common pipe problems are the following:

- The collection of material at the transducer location(s). Accumulated debris at the transducer location(s) will interfere with transmission of the ultrasound signals. As a result, accurate flow rate measurements are not possible. Realignment of the flowcell or transducers often cures such problems, and in some cases, transducers that protrude into the flow stream may be used. Refer to Chapter 2, Installation, for more details on proper installation practices.
- Inaccurate pipe measurements. The accuracy of the flow rate measurements is no better than the accuracy of the programmed pipe dimensions. For a flowcell supplied by Panametrics, the correct data will be included in the documentation. For other flowcells, measure the pipe wall thickness and diameter with the same accuracy desired in the flow rate readings. Also, check the pipe for dents, eccentricity, weld deformity, straightness and other factors that may cause inaccurate readings. Refer to Chapter 3, Initial Setup, for instructions on programming the pipe data.
- In addition to the actual pipe dimensions, the path length (P) and the axial dimension (L), based on the actual transducer mounting locations, must be accurately programmed into the flowmeter. For a Panametrics flowcell, this data will be included with the documentation for the system. If the transducers are mounted onto an existing pipe, these dimensions must be precisely measured.
- The inside of the pipe or flowcell must be relatively clean. Excessive build up of scale, rust or debris will interfere with flow measurement. Generally, a thin coating or a solid well-adhered build up on the pipe wall will not cause problems. Loose scale and thick coatings (such as tar or oil) will interfere with ultrasound transmission and may result in incorrect or unreliable measurements.

4.3.3 Transducer/buffer problems

Ultrasonic transducers are rugged, reliable devices. However, they are subject to physical damage from mishandling and chemical attack. The following list of potential problems is grouped according to transducer type. Contact Panametrics if you cannot solve a transducer-related problem.

- **Leaks:** Leaks may occur around the transducer buffers and/or the flowcell fittings. Repair such leaks immediately. If the leaking fluid is corrosive, carefully check the transducer and cables for damage, after the leak has been repaired.
- **Corrosion Damage:** If the transducer buffer material was not properly chosen for the intended application, they may suffer corrosion damage. The damage usually occurs either at the electrical connector or on the face. If corrosion is suspected, remove the transducer from the flowcell and carefully inspect the buffer electrical connector and the transducer face for roughness and/or pitting. Any transducer damaged in this manner must be replaced. Contact Panametrics for information on transducers in materials suitable for the application.
- **Internal Damage:** An ultrasonic transducer consists of a ceramic crystal bonded to the transducer case. The bond between the crystal and the case or the crystal

itself may be damaged by extreme mechanical shock and/or temperature extremes. Also, the internal wiring can be corroded or shorted if contaminants enter the transducer housing.

- **Physical Damage:** Transducers may be physically damaged by dropping them onto a hard surface or striking them against another object. The transducer connector is the most fragile part and is most subject to damage. Minor damage may be repaired by carefully bending the connector back into shape. If the connector can not be repaired, the transducer must be replaced.

IMPORTANT:

Transducers must be replaced in pairs. Refer to Chapter 3, Initial Setup, to program the new transducer data into the meter.

If the instructions in this section fail to resolve the problem, contact Panametrics for assistance.

[no content intended for this page]

Appendix A. Specifications

A.1 Operation and performance

Fluid Types:

Liquids: Acoustically conductive fluids, including most clean liquids, and many liquids with limited amounts of entrained solids or gas bubbles.

Flow Measurement

Patented Correlation Transit-Time™ mode.

Meter Sizes

Standard: 3 to 16 in. (80 to 600 mm)

Optional: up to 36 in. (900 mm) available upon request.

Accuracy

±0.5% of reading

Range: 3 to 40 ft/s (0.91 to 12.19 m/s)

Calibration Fluid: Water (2 Points)

Final installation assumes a fully developed flow profile (typically 10 diameters upstream and 5 diameters downstream of straight pipe run) and single phase fluids. Applications with piping arrangements that induce swirl (e.g., two out-of-plane elbows) may require additional straight run or flow conditioning.

Repeatability

±0.2% of reading

Range: 3 to 40 ft/s (0.91 to 12.19 m/s)

Range (Bidirectional)

0.1 to 40 ft/s (0.03 to 12.19 m/s)

Rangeability (Overall)

400:1

SIL Certification (Pending)

IEC61508 certified pending

SIL2 certification with single set of electronics

SIL3 achievable with redundant design system

A.2 Meter body/transducer

Meter Body Materials

Carbon Steel (ASTM A106 Gr. B - ASTM A105)

Stainless Steel (ASTM A312 Gr 316/316L - A182 Gr. 316/316L)

9Cr-1Mo (ASTM A335 Gr. P9 - ASTM A182 Gr. F9)

Transducer System and Material

Bundle Waveguide Technology™ System transducer and holder - 316L stainless steel Optional: Other materials available upon request

Transducer Temperature Ranges

Normal temperatures: -310° to 600°F (-190° to 315°C)

Liquids, high temperatures: -310° to 1112°F (-190° to 600°C)

Pressure Range

Up to maximum allowable flange operating pressure at temperature or 3480 psi (240 bar)

Transducer Classifications

US/Canada - Explosion-proof Class I, Division 1, Groups B, C, & D

ATEX - II 2 G Ex db IIC T6 Gb

IECEX - Ex db IIC T6 Gb



Transducer Cables

Integrated cables: Armored cable with ATEX/IECEX-certified cable glands or potted mineral insulated cable Remote cables:

Armored cable with or without ATEX/IECEX-certified cable glands. Option without cable glands requires conduit or other means to meet local codes.

A.3 Electronics

Enclosures

Epoxy coated, copper free, aluminum, weatherproof (IP67)

Electronics Classifications (Pending)

USA/Canada- Explosion-proof Class I, Division 1, Groups B, C, & D

ATEX - Flameproof II 2 G Ex db IIC T6 Gb

IECEX - Flameproof Ex db IIC T6 Gb

ROHS compliance 2011/65/EU

(Category 9 Exemption)

CE (EMC directive 2014/30/EU, LVD 2014/35/EU & ATEX directive 2014/34/EU)

WEEE Compliance

Note: The electronics package includes an installed battery which shall only be replaced at a Panametrics Service center. Replacement involves de-soldering battery contacts, which could lead to a breach of Functional Safety. Please contact Panametrics Service to get this battery replaced.

Electronics Mounting

Local Mounting (on meter body)

Remote Mounting (up to 100 ft / 30.4 m). Recommended for process temperatures exceeding 150°C.

Channels

One or Two (two channels for two-path averaging)

Display Languages

English

Keypad

Built-in magnetic, six-button keypad, for full functionality operation

Inputs/Outputs

Option A: One analog output/SIL with HART**, two digital* outputs, service/Modbus(RS485) output, calibration output

Option B: One analog output/SIL with HART**, one additional analog output**, two digital* outputs, service/Modbus(RS485) output, calibration output

*Digital outputs are programmable as either pulse, frequency, alarm, or control outputs

**Analog outputs are NAMUR NE43 compliant

A.3 Electronics (cont.)

	I/O Type	Connection	Specifications
Output A	SIL Analog Output + HART	Active Output	Output current: 0–22 mA Max load: 600 Ω
Output B (Option B only)	Analog Output	Active Output	Output current: 0–22 mA Max load: 600 Ω
Output C	Pulse, Frequency, Alarm or Control	Active Output	Output voltage: 5 VDC Max. voltage with light load: 7 VDC Includes integrated current limit resistor. Customer current limitation not required.
Output D	Pulse, Frequency, Alarm or Control	Active Output	Output voltage: 5 VDC Max. voltage with light load: 7 VDC Includes integrated current limit resistor. Customer current limitation not required.

Table 6: I/O Terminal Block

TB	I/O Type	Connection	Specifications
Modbus	RS485	RS485 Communications	Standard RS485 communications port
Cal Out	Frequency Output	Passive Output	Max customer supply voltage: 30 VDC Max current draw: 200 mA Recommended load: 300 Ω

Table 7: Modbus/Cal Terminal Block

Power Supplies

Standard: 100–240 VAC (50/60 Hz) Optional: 12 to 28 VDC

Power Consumption

10 Watts maximum

Wiring Connection

All conduit entries are M20 or M25. ¾" NPT can be ordered (with adapter)

Operating Temperature

–40° to 140°F (–40° to +60°C)

Note: The LCD display is only visible down to –13°F (–25°C). Storage Temperature

–40° to 158°F (–40° to 70°C)

Data Logging

Requires Vitality Software
XMT900 logging

Appendix B. Menu maps

The following 11 x17 foldout menu maps are included in this appendix:

- Figure 29, “Display Measurement Menu Map,” on page 91
- Figure 30, “Meter Programming Overview,” on page 92
- Figure 31, “Display Menu Map,” on page 93
- Figure 32, “Input / Output Menu Map,” on page 94
- Figure 33, “SIL Testing Menu Map,” on page 95

[no content intended for this page]

Press \checkmark to enter the Display Measurement menu.

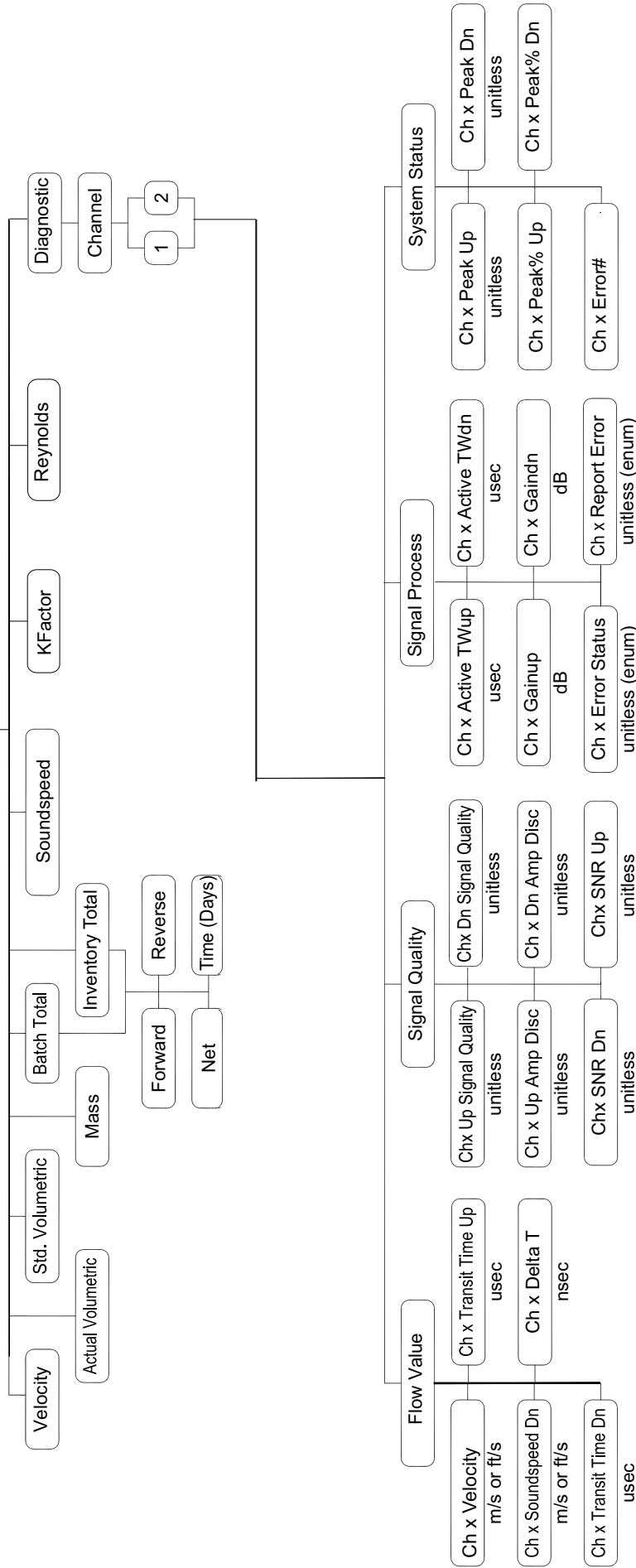


Figure 29: Display Measurement Menu Map

Note: Display either 1 variable, 2 variables, or totalizer.

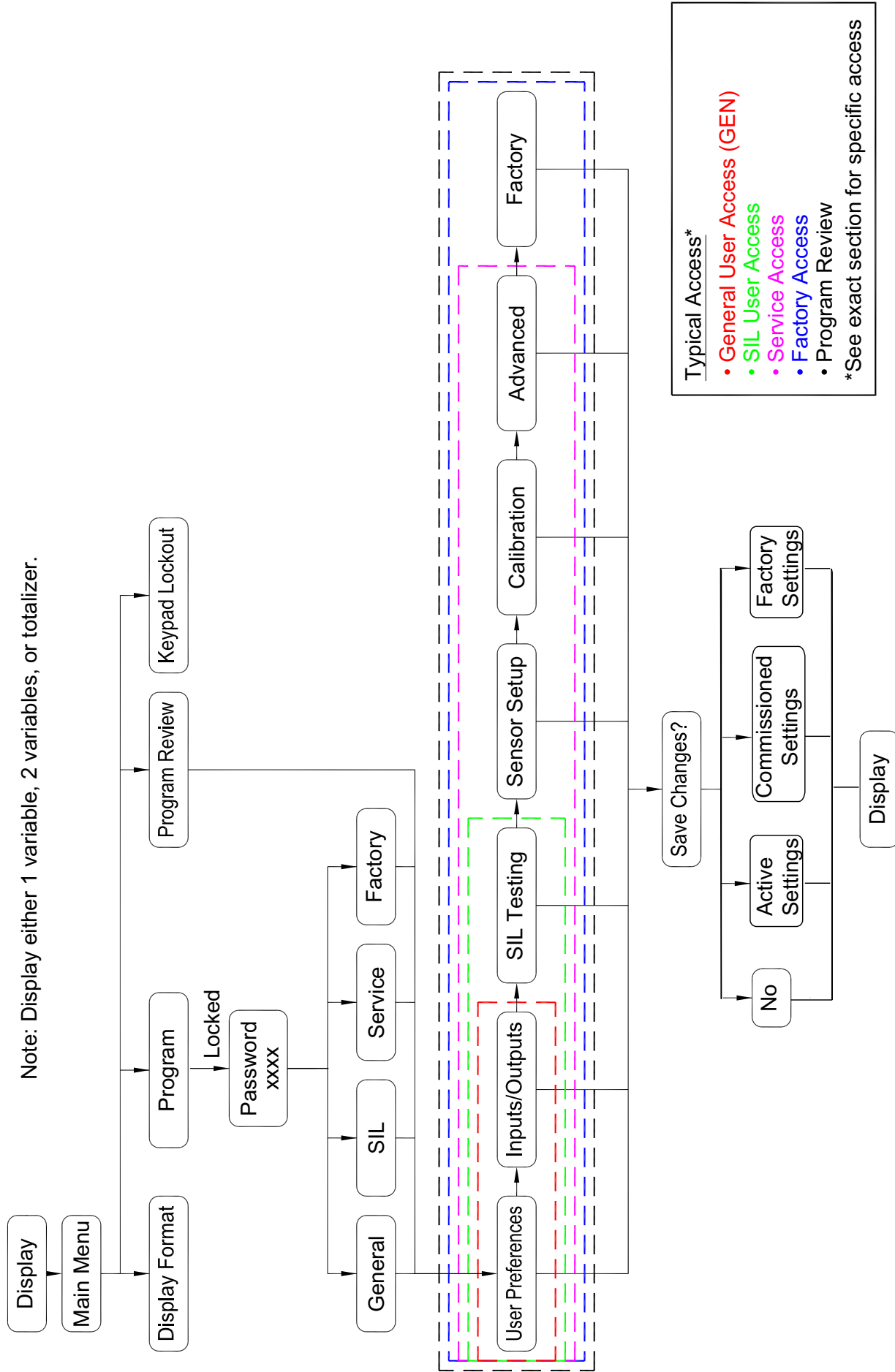


Figure 30: Meter Programming Overview

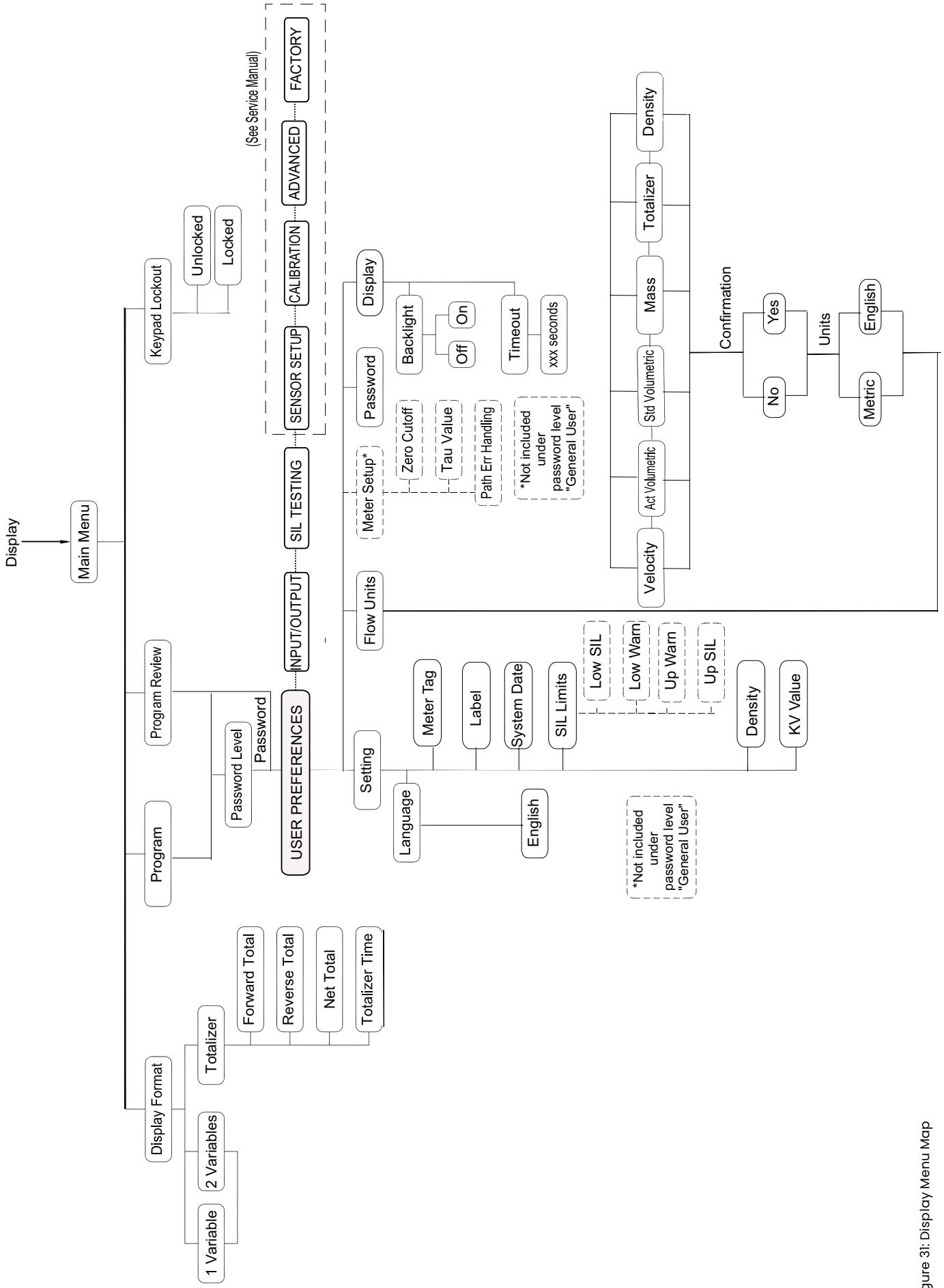


Figure 31: Display Menu Map

To enter the Input/Output menu, on the initial screen, highlight the lock symbol and press [N]. Select Program and press [N]. Then enter a SIL or higher level password. In the User Preference menu, select Setting, then press the right arrow key.

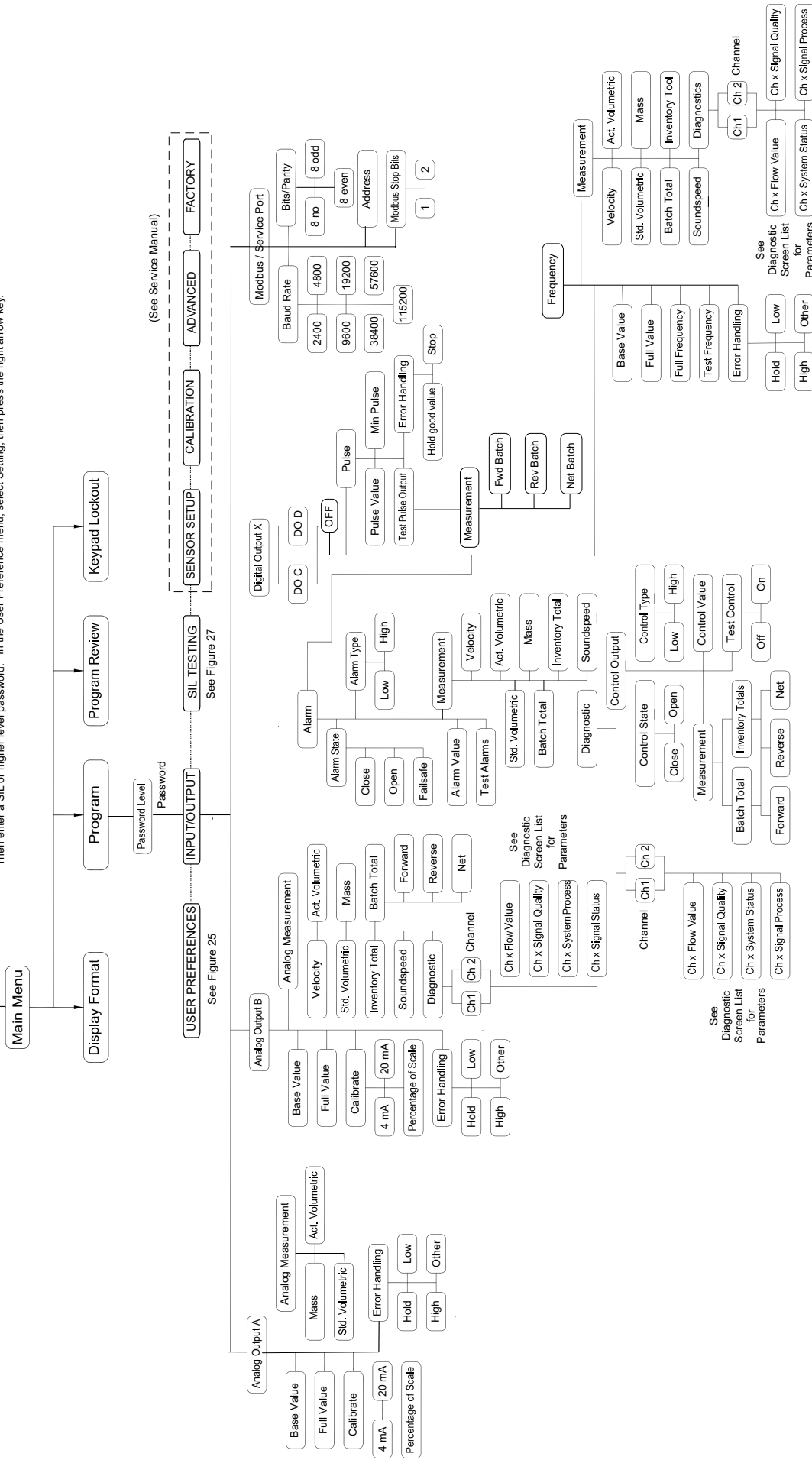


Figure 32: Input / Output Menu Map

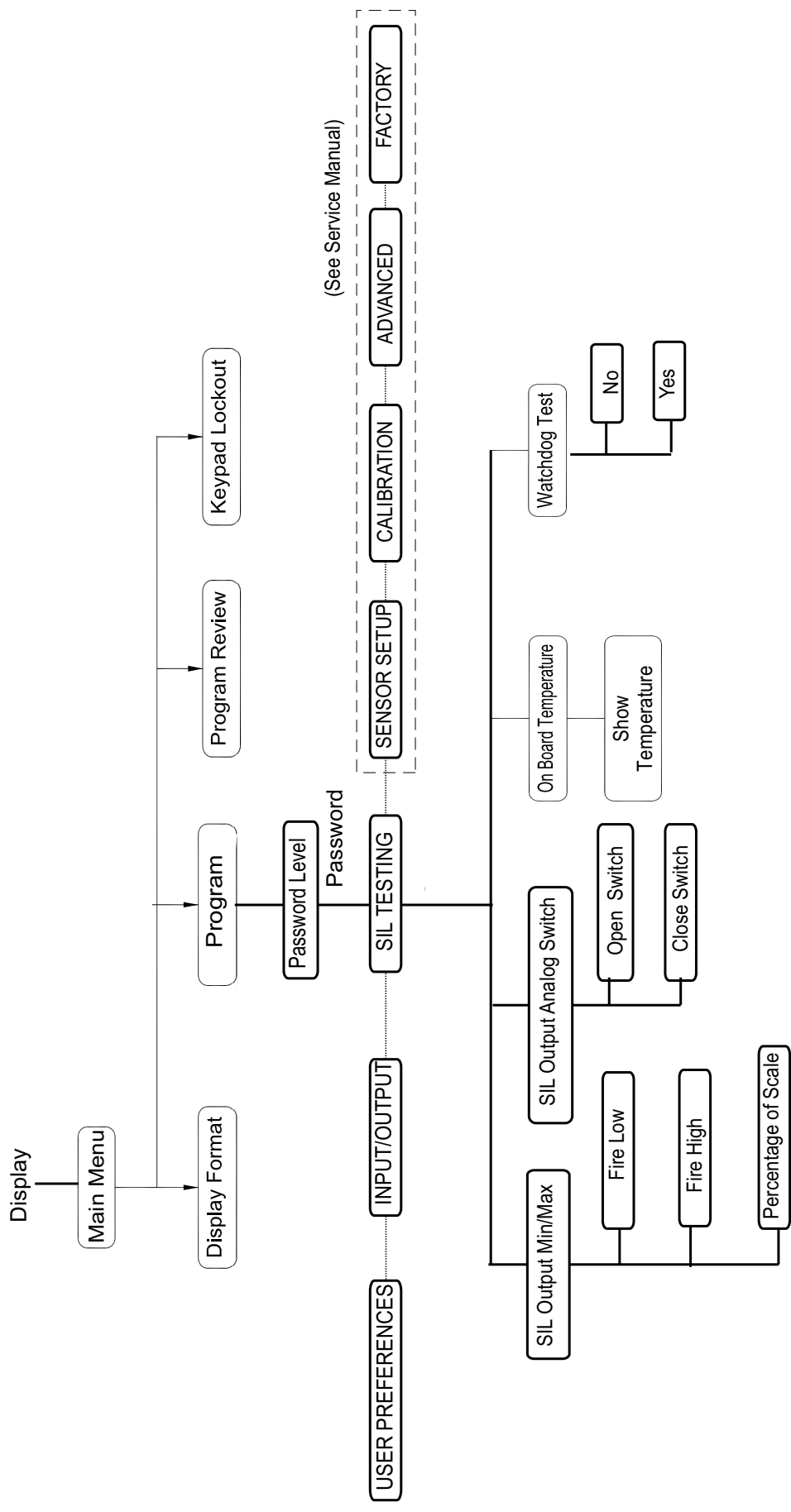


Figure 33: SIL Testing Menu Map

[no content intended for this page]

Appendix C. Modbus map

C.1 Frequently used modbus addresses

Register (in Hex)	Register (in Decimal)	Access Level	Variable	Units	Read Only/ Read Write	Format
5C0	1472	Gen User	Meter Tag	18	RW	CHAR * 16
5C8	1480	Gen User	Long Tag	18	RW	CHAR * 32
740	1856	VIEWER	master error Master Error: See error code tables.	18	RO	INT32
8200	33280	VIEWER	Composite Velocity	20	RO	(IEEE 32 bit)
8202	33282	VIEWER	Composite Volumetric	1	RO	(IEEE 32 bit)
8204	33284	VIEWER	Composite Mass Flow	9	RO	(IEEE 32 bit)
8206	33286	VIEWER	Composite Fwd Batch Totals	17	RO	(IEEE 32 bit)
8208	33288	VIEWER	Composite Rev Batch Totals	17	RO	(IEEE 32 bit)
820A	33290	VIEWER	Composite Totalizer Time	16	RO	(IEEE 32 bit)
821A	33306	VIEWER	Composite Standard Volumetric	14	RO	(IEEE 32 bit)
821C	33308	VIEWER	Composite Net Batch Totals	17	RO	(IEEE 32 bit)
604	1540	VIEWER	Composite Net Inventory Totals	17	RO	(IEEE 32 bit)
8220	33312	VIEWER	Composite SIL Analog Out Drive Current	8	RO	(IEEE 32 bit)
8302	33538	VIEWER	Composite SIL errors:epSIL_Value_Health_Code_I: Use dropdown	18	RO	INT32
8304	33540	VIEWER	Composite most significant error (see Error Tables)	18	RO	INT32
820C	33292	VIEWER	Composite Sound Speed	20	RO	(IEEE 32 bit)
8602	34306	VIEWER	Ch_1 Sound Speed	20	RO	(IEEE 32 bit)
8A02	35330	VIEWER	Ch_2 Sound Speed	20	RO	(IEEE 32 bit)
8618	34328	VIEWER	Ch_1_SNR on UP channel	18	RO	(IEEE 32 bit)
861A	34330	VIEWER	Ch_1_SNR on DOWN channel	18	RO	(IEEE 32 bit)
8A18	35352	VIEWER	Ch_2_SNR on UP channel	18	RO	(IEEE 32 bit)
8A1A	35354	VIEWER	Ch_2_SNR on DOWN channel	18	RO	(IEEE 32 bit)

Table 8: Frequently Used Modbus Addresses

C.2 User group definitions

Unit Group	Group Name	Valid Unit Codes (See “Unit Codes for XMT900” on page 124)
1	Actual Volumetric	1347, 1348, 1349, 1350, 1351, 1352, 1353, 1354, 1356, 1357, 1358, 1359, 1362, 1363, 1364, 1365, 1371, 1371, 1372, 1372, 1373, 1373, 1374, 1374, 1454, 1454, 1462, 1462, 1485, 1485, 1489, 1489, 1493, 1493, 1548, 1548
2	Day	1060
3	dB	1383
4	Density	1097, 1100, 1103, 1104, 1106, 1107, 1108
5	Dimension	1013, 1019
6	Hz	1077
7	Viscosity	1160, 1164
8	mA	1211
9	Mass	1322, 1323, 1324, 1325, 1326, 1327, 1328, 1329, 1330, 1331, 1332, 1333, 1334, 1335, 1336, 1337, 1641, 1642, 1643, 1644
10	Milliseconds	1056
11	Nanoseconds	nsec (pending)
12	Percent	1342
13	Seconds	1054
14	Standard Volumetric	1361, 1360, 1537, 1538, 1539, 1540, 1527, 1528, 1529, 1530
15	Thermal	1001, 1002
16	Totalizer time	1054, 1058, 1059, 1060
17	Totalizer	1034, 1038, 1043, 1051, 1051, 1053, 1088, 1092, 1094, 1526, 1536, 1645, 1664, 1664, 1665, 1666, 1667
18	Unitless	1615
19	Microseconds	1057
20	Velocity	1061, 1067
21	Reynolds number	1615

Table 9: User Group Definitions

C.3 Modbus map

Register (in Hex)	Register (in Decimal)	Access Level	Variable	Unit Group	Read Only/Read Write	Format
Health Check and Identification Registers						
20	512		System Error Bits	18	RO	INT32
202	514		Live Runtime	18	RO	INT32
204	516		Transmitter Status 0: Measurement; 1: Calibration;	18	RO	INT32
210	528	NONE	Product Type	18	RO	INT32
212	530	NONE	Product Code	18	RO	CHARx16
222	546	NONE	MPU serial number	18	RO	CHARx16
22A	554	NONE	Analog Board revision	18	RO	CHARx16
232	562	NONE	Application Software Version	18	RO	CHARx16
23A	570	NONE	Boot Loader Software Version	18	RO	CHARx16
242	578	NONE	I/O Board type	18	RO	INT32
250	592	SERVICE	MPU baud rate (fixed)	18	RW	INT32
252	594	SERVICE	MPU parity (fixed) 0: Even, 1: Odd, 2: No	18	RW	INT32
254	596	SERVICE	MPU number of stop bits (fixed) 0: no stop bits, 1: one stop bits, 2: two stop bits	18	RW	INT32
256	598	SERVICE	MPU Modbus node ID (fixed)	18	RW	INT32
258	600	SERVICE	MPU number of bits per character (fixed)	18	RW	INT32
25A	602	SERVICE	MPU is this a termination node? (fixed) 0: Not a termination, 1: Is a termination	18	RW	INT32
System Integer Read/Write						
500	1280	Gen User	Global Unit group 1 for Actual Volumetric	18	RW	INT32
502	1282	Gen User	Global Unit group 2 for Day	18	RW	INT32
504	1284	Gen User	Global Unit group 3 for dB	18	RW	INT32
506	1286	Gen User	Global Unit group 4 for Density	18	RW	INT32
508	1288	Gen User	Global Unit group 5 for Dimension	18	RW	INT32
50A	1290	Gen User	Global Unit group 6 for Hz	18	RW	INT32
50C	1292	Gen User	Global Unit group 7 for Viscosity	18	RW	INT32
50E	1294	Gen User	Global Unit group 8 for mA	18	RW	INT32
510	1296	Gen User	Global Unit group 9 for Mass	18	RW	INT32
512	1298	Gen User	Global Unit group 10 for Milli Second	18	RW	INT32
514	1300	Gen User	Global Unit group 11 for Nano Second	18	RW	INT32
516	1302	Gen User	Global Unit group 12 for Percent	18	RW	INT32
518	1304	Gen User	Global Unit group 13 for Second	18	RW	INT32

Table 10: XMIT Modbus Map

Register (in Hex)	Register (in Decimal)	Access Level	Variable	Unit Group	Read Only/Read Write	Format
51A	1306	Gen User	Global Unit group 14 for Standard Volumetric	18	RW	INT32
51C	1308	Gen User	Global Unit group 15 for Therm	18	RW	INT32
51E	1310	Gen User	Global Unit group 16 for Totalizer time	18	RW	INT32
520	1312	Gen User	Global Unit group 17 for Totalizer	18	RW	INT32
522	1314	Gen User	Global Unit group 18 for Unitless	18	RW	INT32
524	1316	Gen User	Global Unit group 19 for Micro Second	18	RW	INT32
526	1318	Gen User	Global Unit group 20 for Velocity	18	RW	INT32
528	1320	Gen User	Global Unit group 21 for Reynolds	18	RW	INT32
52A	1322	Gen User	Reserved Global Unit group 22	18	RW	INT32
52C	1324	Gen User	Reserved Global Unit group 23	18	RW	INT32
52E	1326	Gen User	Reserved Global Unit group 24	18	RW	INT32
540	1344	VIEWER	system request level	18	RW	INT32
580	1408	SERVICE	PC MODBUS baud rate	18	RW	INT32
582	1410	SERVICE	PC MODBUS parity	18	RW	INT32
584	1412	SERVICE	PC MODBUS stop bits	18	RW	INT32
586	1414	SERVICE	PC MODBUS meter addr	18	RW	INT32
588	1416	SERVICE	PC MODBUS bits per character	18	RW	INT32
58A	1418	SERVICE	PC MODBUS termination	18	RW	INT32
5C0	1472	Gen User	Meter Tag	18	RW	CHAR * 16
5C8	1480	Gen User	Long Tag	18	RW	CHAR * 32
5D8	1496	FACTORY	Option Board Type	18	RW	INT32
System Real Read Only						
600	1536	VIEWER	inventory fwd totals	17	RO	(IEEE 32 bit)
602	1538	VIEWER	inventory rev totals	17	RO	(IEEE 32 bit)
604	1540	VIEWER	inventory net totals	17	RO	(IEEE 32 bit)
606	1542	VIEWER	inventory totals time	16	RO	(IEEE 32 bit)
System Integer Read Only						
700	1792	VIEWER	NetworkID_Max	18	RO	INT32
702	1794	VIEWER	NetworkID_Min	18	RO	INT32
704	1796	VIEWER	General user password	18	RO	INT32
706	1798	VIEWER	MCU serial number	18	RO	INT32
708	1800	VIEWER	MCU bootloader version	18	RO	INT32
70A	1802	VIEWER	MCU Software version	18	RO	INT32
70C	1804	VIEWER	MCU Hardware version	18	RO	INT32
70E	1806	VIEWER	Option Software version	18	RO	INT32
710	1808	VIEWER	Option Hardware version	18	RO	INT32
712	1810	VIEWER	MCU flash CRC	18	RO	INT32
740	1856	VIEWER	master error Master Error: See error code tables.	18	RO	INT32

Table 10: XMIT Modbus Map (cont.)

Register (in Hex)	Register (in Decimal)	Access Level	Variable	Unit Group	Read Only/ Read Write	Format
742	1858	VIEWER	MCU error MCU error: See error code tables.	18	RO	INT32
744	1860	VIEWER	Option error Option error: See error code tables.	18	RO	INT32
746	1862	VIEWER	MCU startup error MCU startup error: See error code tables.	18	RO	INT32
748	1864	VIEWER	Option startup error Option startup error: See error code tables.	18	RO	INT32

Display Integer Read Write

900	2304	Gen User	Display Language	18	RW	INT32
902	2306	VIEWER	Display Variable_1 Register Address	18	RW	INT32
904	2308	VIEWER	Display Variable_1 Unit Code Address	18	RW	INT32
906	2310	VIEWER	Display Variable_2 Register Address	18	RW	INT32
908	2312	VIEWER	Display Variable_2 Unit Code Address	18	RW	INT32
90A	2314	VIEWER	Display Totalizer_1 Register Address	18	RW	INT32
90C	2316	VIEWER	Display Totalizer_1 Unit Code Address	18	RW	INT32
90E	2318	VIEWER	Display Totalizer_2 Register Address	18	RW	INT32
910	2320	VIEWER	Display Totalizer_2 Unit Code Address	18	RW	INT32
912	2322	VIEWER	Display Graph_1 Register Address	18	RW	INT32
914	2324	VIEWER	Display Graph_1 Unit Code Address	18	RW	INT32
916	2326	Gen User	select the velocity	18	RW	INT32
918	2328	Gen User	select the Actual Volumetric	18	RW	INT32
91A	2330	Gen User	select the Standardized Volumetric	18	RW	INT32
91C	2332	Gen User	select Mass	18	RW	INT32
91E	2334	Gen User	select Totalizer	18	RW	INT32
920	2336	Gen User	select Density	18	RW	INT32
922	2338	VIEWER	Select Decimal	18	RW	INT32
924	2340	VIEWER	the type of DISPLAY	18	RW	INT32
926	2342	Gen User	TimeOut for DISPLAY	13	RW	INT32
928	2344	Gen User	BackLight Control	18	RW	INT32
92A	2346	VIEWER	Lock menu	18	RW	INT32
92C	2348	Gen User	Unit type for velocity 0: for Metric, 1: for English	18	RW	INT32
92E	2350	Gen User	Unit type for actual volumetric 0: for Metric, 1: for English	18	RW	INT32
930	2352	Gen User	Unit type for standard volumetric 0: for Metric, 1: for English	18	RW	INT32
932	2354	Gen User	Unit type for mass 0: for Metric, 1: for English	18	RW	INT32
934	2356	Gen User	Unit type for totalizer 0: Avol, 1: Svol, 2:Mass	18	RW	INT32

Table 10: XMIT Modbus Map (cont.)

Register (in Hex)	Register (in Decimal)	Access Level	Variable	Unit Group	Read Only/Read Write	Format
936	2358	Gen User	Unit type for Actual volumetric of totalize 0: for Metric, 1: for English	18	RW	INT33
938	2360	Gen User	Unit type for Standard volumetric of totalizer 0: for Metric, 1: for English	18	RW	INT34
93A	2362	Gen User	Unit type for Mass of totalizer 0: for Metric, 1: for English	18	RW	INT35
93C	2364	Gen User	Unit type for Density 0: for Metric, 1: for English	18	RW	INT32
Display Integer Read Only						
B00	2816	VIEWER	Maximum TimeOut for DISPLAY	18	RO	INT32
B02	2818	VIEWER	Minimum TimeOut for DISPLAY	18	RO	INT32
Log Integer Read Write						
D00	3328	Gen User	Log control / status	18	RW	INT32
D02	3330	Gen User	Log interval	13	RW	INT32
D04	3332	Gen User	Logging time	13	RW	INT32
D06	3334	Gen User	Number of variables to log	18	RW	INT32
D40	3392	Gen User	variable address array	18	RW	INT32
D80	3456	Gen User	Variable unit code array	18	RW	INT32
Log Integer Read Only						
F00	3840	N/A	Number of records	18	RO	INT32
Analog Out 2 Real Read Write						
1000	4096	Gen User	Analog Out 2 Error Handling Value	8	RW	(IEEE 32 bit)
1002	4098	Gen User	Analog Out 2 Zero	8	RW	(IEEE 32 bit)
1004	4100	Gen User	Analog Out 2 Span	8	RW	(IEEE 32 bit)
1006	4102	Gen User	Analog Out 2 Test Value (Percent of Span)	12	RW	(IEEE 32 bit)
1008	4104	Gen User	Analog Out 2 Base Value	18	RW	(IEEE 32 bit)
100A	4106	Gen User	Analog Out 2 Full Value	18	RW	(IEEE 32 bit)
Analog Out 2 Integer Read Write						
1180	4480	Gen User	Analog Out 2 Operating Mode	18	RW	INT32
1182	4482	Gen User	Analog Out 2 Type	18	RW	INT32
1184	4484	Gen User	Analog Out 2 Measurement Register Address	18	RW	INT32
1186	4486	Gen User	Analog Out 2 Error Handling	18	RW	INT32
1188	4488	Gen User	Analog Out 2 Unit code	18	RW	INT32
Analog Out 2 Max Real Read Only						
1600	5632	VIEWER	Maximum Analog Out 2 Error Handling Value	8	RO	(IEEE 32 bit)
1602	5634	VIEWER	Maximum Analog Out 2 Zero	8	RO	(IEEE 32 bit)
1604	5636	VIEWER	Maximum Analog Out 2 Span	8	RO	(IEEE 32 bit)

Table 10: XMIT Modbus Map (cont.)

Register (in Hex)	Register (in Decimal)	Access Level	Variable	Unit Group	Read Only/Read Write	Format
1606	5638	VIEWER	Maximum Analog Out 2 Test Value (Percent of Span)	12	RO	(IEEE 32 bit)
1608	5640	VIEWER	Maximum Analog Out 2 Base Value	18	RO	(IEEE 32 bit)
160A	5642	VIEWER	Maximum Analog Out 2 Full Value	18	RO	(IEEE 32 bit)
Analog Out 2 Min Real Read Only						
1A00	6656	VIEWER	Minimum Analog Out 2 Error Handling Value	8	RO	(IEEE 32 bit)
1A02	6658	VIEWER	Minimum Analog Out 2 Zero	8	RO	(IEEE 32 bit)
1A04	6660	VIEWER	Minimum Analog Out 2 Span	8	RO	(IEEE 32 bit)
1A06	6662	VIEWER	Minimum Analog Out 2 Test Value (Percent of Span)	12	RO	(IEEE 32 bit)
1A08	6664	VIEWER	Minimum Analog Out 2 Base Value	18	RO	(IEEE 32 bit)
1A0A	6666	VIEWER	Minimum Analog Out 2 Full Value	18	RO	(IEEE 32 bit)
Digital Out 1 Real Read Write						
2000	8192	Gen User	Output_1 Pulse Value	18	RW	(IEEE 32 bit)
2002	8194	Gen User	Output_1 Pulse Time	10	RW	(IEEE 32 bit)
2004	8196	Gen User	Output_1 Frequency Base Value	18	RW	(IEEE 32 bit)
2006	8198	Gen User	Output_1 Frequency Full Value	18	RW	(IEEE 32 bit)
2008	8200	Gen User	Output_1 Alarm Value	18	RW	(IEEE 32 bit)
200A	8202	Gen User	Output_1 Control Output Value	18	RW	(IEEE 32 bit)
Digital Out 1 Integer Read Write						
2100	8448	Gen User	Output_1 Test Pulse Value	18	RW	INT32
2102	8450	Gen User	Output_1 Frequency Full Frequency	6	RW	INT32
2104	8452	Gen User	Output_1 Test Frequency Value	6	RW	INT32
2106	8454	Gen User	Output_1 Frequency Error Handling Value	6	RW	INT32
2180	8576	Gen User	Output_1 type	18	RW	INT32
2182	8578	Gen User	Output_1 Pulse Value Unit Code	18	RW	INT32
2184	8580	Gen User	Output_1 Pulse Error Handling	18	RW	INT32
2186	8582	Gen User	Output_1 Frequency Measurement Register Address	18	RW	INT32
2188	8584	Gen User	Output_1 Frequency Error Handling	18	RW	INT32
218A	8586	Gen User	Output_1 Frequency Unit code	18	RW	INT32
218C	8588	Gen User	Output_1 Alarm State	18	RW	INT32
218E	8590	Gen User	Output_1 Alarm Type	18	RW	INT32
2190	8592	Gen User	Output_1 Alarm Measurement Register Address	18	RW	INT32
2192	8594	Gen User	Output_1 Alarm Unit code	18	RW	INT32
2194	8596	Gen User	Output_1 Test Alarm	18	RW	INT32
2196	8598	Gen User	Output_1 Control Output State	18	RW	INT32
2198	8600	Gen User	Output_1 Control Output Type	18	RW	INT32

Table 10: XMIT Modbus Map (cont.)

Register (in Hex)	Register (in Decimal)	Access Level	Variable	Unit Group	Read Only/Read Write	Format
219A	8602	Gen User	Output_1 Control Output Measurement Register Address	18	RW	INT32
219C	8604	Gen User	Output_1 Control Output Unit code	18	RW	INT32
219E	8606	Gen User	Output_1 Test Control Output	18	RW	INT32
21A0	8608	Gen User	Output_1 Reserved	18	RW	INT32
21A2	8610	Gen User	Output_1 Test Mode 0: Test Off; 1: Test On	18	RW	INT32
21A4	8612	Gen User	Output_1 Pulse Measurement Register Address	18	RW	INT32
Digital Out 2 Real Read Write						
2400	9216	Gen User	Output_2 Pulse Value	18	RW	(IEEE 32 bit)
2402	9218	Gen User	Output_2 Pulse Time	10	RW	(IEEE 32 bit)
2404	9220	Gen User	Output_2 Frequency Base Value	18	RW	(IEEE 32 bit)
2406	9222	Gen User	Output_2 Frequency Full Value	18	RW	(IEEE 32 bit)
2408	9224	Gen User	Output_2 Alarm Value	18	RW	(IEEE 32 bit)
240A	9226	Gen User	Output_2 Control Output Value	18	RW	(IEEE 32 bit)
Digital Out 2 Integer Read Write						
2500	9472	Gen User	Output_2 Test Pulse Value	18	RW	INT32
2502	9474	Gen User	Output_2 Frequency Full Frequency	6	RW	INT32
2504	9476	Gen User	Output_2 Test Frequency Value	6	RW	INT32
2506	9478	Gen User	Output_2 Frequency Error Handling Value	6	RW	INT32
2580	9600	Gen User	Output_2 type	18	RW	INT32
2582	9602	Gen User	Output_2 Pulse Value Unit Code	18	RW	INT32
2584	9604	Gen User	Output_2 Pulse Error Handling	18	RW	INT32
2586	9606	Gen User	Output_2 Frequency Measurement Register Address	18	RW	INT32
2588	9608	Gen User	Output_2 Frequency Error Handling	18	RW	INT32
258A	9610	Gen User	Output_2 Frequency Unit code	18	RW	INT32
258C	9612	Gen User	Output_2 Alarm State	18	RW	INT32
258E	9614	Gen User	Output_2 Alarm Type	18	RW	INT32
2590	9616	Gen User	Output_2 Alarm Measurement Register Address	18	RW	INT32
2592	9618	Gen User	Output_2 Alarm Unit code	18	RW	INT32
2594	9620	Gen User	Output_2 Test Alarm	18	RW	INT32
2596	9622	Gen User	Output_2 Control Output State	18	RW	INT32
2598	9624	Gen User	Output_2 Control Output Type	18	RW	INT32
259A	9626	Gen User	Output_2 Control Output Measurement Register Address	18	RW	INT32
259C	9628	Gen User	Output_2 Control Output Unit code	18	RW	INT32
259E	9630	Gen User	Output_2 Test Control Output	18	RW	INT32
25A0	9632	Gen User	Output_2 Phase Shift	18	RW	INT32

Table 10: XMIT Modbus Map (cont.)

Register (in Hex)	Register (in Decimal)	Access Level	Variable	Unit Group	Read Only/ Read Write	Format
25A2	9634	Gen User	Output_2 Test Mode 0: Test Off; 1: Test O	18	RW	INT32
25A4	9636	Gen User	Output_2 Pulse Measurement Register Address	18	RW	INT32
Digital Out Max Real Read Only						
2A00	10752	VIEWER	Maximum Output_1 Pulse Value	18	RO	(IEEE 32 bit)
2A02	10754	VIEWER	Maximum Output_1 Pulse Time	10	RO	(IEEE 32 bit)
2A04	10756	VIEWER	Maximum Output_1 Frequency Base Value	18	RO	(IEEE 32 bit)
2A06	10758	VIEWER	Maximum Output_1 Frequency Full Value	18	RO	(IEEE 32 bit)
2A08	10670	VIEWER	Maximum Output_1 Alarm Value	18	RO	(IEEE 32 bit)
2A0A	10762	VIEWER	Maximum Output_1 Control Output Value	18	RO	(IEEE 32 bit)
2A80	10880	VIEWER	Maximum Output_2 Pulse Value	18	RO	(IEEE 32 bit)
2A82	10882	VIEWER	Maximum Output_2 Pulse Time	10	RO	(IEEE 32 bit)
2A84	10884	VIEWER	Maximum Output_2 Frequency Base Value	18	RO	(IEEE 32 bit)
2A86	10886	VIEWER	Maximum Output_2 Frequency Full Value	18	RO	(IEEE 32 bit)
2A88	10888	VIEWER	Maximum Output_2 Alarm Value	18	RO	(IEEE 32 bit)
2A8A	10890	VIEWER	Maximum Output_2 Control Output Value	18	RO	(IEEE 32 bit)
Digital Out Max Integer Read Only						
2B00	11008	VIEWER	Maximum Output_1 Test Pulse Value	18	RO	INT32
2B02	11010	VIEWER	Maximum Output_1 Frequency Full Frequency	6	RO	INT32
2B04	11012	VIEWER	Maximum Output_1 Test Frequency Value	6	RO	INT32
2B06	11014	VIEWER	Maximum Output_1 Frequency Error Handling Value	6	RO	INT32
2B80	11136	VIEWER	Maximum Output_2 Test Pulse Value	18	RO	INT32
2B82	11138	VIEWER	Maximum Output_2 Frequency Full Frequency	6	RO	INT32
2B84	11140	VIEWER	Maximum Output_2 Test Frequency Value	6	RO	INT32
2B86	11142	VIEWER	Maximum Output_2 Frequency Error Handling Value	6	RO	INT32
Digital Out Min Real Read Only						
2E00	2	VIEWER	Minimum Output_1 Pulse Value	18	RO	(IEEE 32 bit)
2E02	512	VIEWER	Minimum Output_1 Pulse Time	10	RO	(IEEE 32 bit)
2E04	131072	VIEWER	Minimum Output_1 Frequency Base Value	18	RO	(IEEE 32 bit)
2E06	33554432	VIEWER	Minimum Output_1 Frequency Full Value	18	RO	(IEEE 32 bit)

Table 10: XMIT Modbus Map (cont.)

Register (in Hex)	Register (in Decimal)	Access Level	Variable	Unit Group	Read Only/Read Write	Format
2E08	8589934592	VIEWER	Minimum Output_1 Alarm Value	18	RO	(IEEE 32 bit)
2E0A	11786	VIEWER	Minimum Output_1 Control Output Value	18	RO	(IEEE 32 bit)
2E80		VIEWER	Minimum Output_2 Pulse Value	18	RO	(IEEE 32 bit)
2E82		VIEWER	Minimum Output_2 Pulse Time	10	RO	(IEEE 32 bit)
2E84		VIEWER	Minimum Output_2 Frequency Base Value	18	RO	(IEEE 32 bit)
2E86		VIEWER	Minimum Output_2 Frequency Full Value	18	RO	(IEEE 32 bit)
2E88		VIEWER	Minimum Output_2 Alarm Value	18	RO	(IEEE 32 bit)
2E8A	11914	VIEWER	Minimum Output_2 Control Output Value	18	RO	(IEEE 32 bit)
Digital Out Min Integer Read Only						
2F00	12032	VIEWER	Minimum Output_1 Test Pulse Value	18	RO	INT32
2F02	12034	VIEWER	Minimum Output_1 Frequency Full Frequency	6	RO	INT32
2F04	12036	VIEWER	Minimum Output_1 Test Frequency Value	6	RO	INT32
2F06	12038	VIEWER	Minimum Output_1 Frequency Error Handling Value	6	RO	INT32
2F80	12160	VIEWER	Minimum Output_2 Test Pulse Value	18	RO	INT32
2F82	12162	VIEWER	Minimum Output_2 Frequency Full Frequency	6	RO	INT32
2F84	12164	VIEWER	Minimum Output_2 Test Frequency Value	6	RO	INT32
2F86	12166	VIEWER	Minimum Output_2 Frequency Error Handling Value	6	RO	INT32
HART Integer Read Write						
3100	12544	VIEWER	Hart unit code	18	RW	INT32
Files						
3000	12288	VIEWER	Flow Monitoring log	18	RO	
3001	12289	VIEWER	Error log	18	RO	
Flow Measurement Registers						
Configurations (Holding Registers)						
Composite Channel Real - FF Terminal Block 2						
8000	32768	SERVICE	Composite Span value for frequency output	1, 14 or 20	RW	(IEEE 32 bit)
8002	32770	SERVICE	Composite Pipe Inner Diameter	5	RW	(IEEE 32 bit)
8004	32772	SERVICE	Composite Pipe Outer Diameter	5	RW	(IEEE 32 bit)
8006	32774	SERVICE	Composite Pipe Wall Thickness	5	RW	(IEEE 32 bit)
8008	32776	SERVICE	Composite Velocity Warn High limit - Alarm limits-Normal operation	20	RW	(IEEE 32 bit)
800A	32778	SIL USER	Composite Analog out percent scale	12	RW	(IEEE 32 bit)

Table 10: XMIT Modbus Map (cont.)

Register (in Hex)	Register (in Decimal)	Access Level	Variable	Unit Group	Read Only/Read Write	Format
800C	32780	SIL USER	Composite Static Density	4	RW	(IEEE 32 bit)
800E	32782	SERVICE	Composite Acceleration Limit	18	RW	(IEEE 32 bit)
8010	32784	SERVICE	Composite Amplitude discriminator min limit	18	RW	(IEEE 32 bit)
8012	32786	SERVICE	Composite Amplitude discriminator max limit	18	RW	(IEEE 32 bit)
8014	32788	SIL USER	Composite Kinematic Viscosity	7	RW	(IEEE 32 bit)
8016	32790	SERVICE	Composite Calibration Factor	18	RW	(IEEE 32 bit)
8018	32792	SIL USER	Composite Zero Cutoff	20	RW	(IEEE 32 bit)
801A	32794	SIL USER	Composite Response Time	13	RW	(IEEE 32 bit)
801C	32796	SIL USER	Composite Analog Output Low Limit point as entered in the system	1, 9, 14	RW	(IEEE 32 bit)
801E	32798	SIL USER	Composite Analog Output High Limit as entered in the system	1, 9, 14	RW	(IEEE 32 bit)
8020	32800	SIL USER	Composite Zero Set point as entered into the system by user	8	RW	(IEEE 32 bit)
8022	32802	SIL USER	Composite Span Set point as entered into the system by user	8	RW	(IEEE 32 bit)
8024	32804	SIL USER	Composite Velocity Low limit - Used for Volumetric low limit calculation	20	RW	(IEEE 32 bit)
8026	32806	SIL USER	Composite Velocity High limit - Used for Volumetric High limit calculation	20	RW	(IEEE 32 bit)
8028	32808	SIL USER	Composite Velocity Warn Low limit - Alarm limits-Normal operation	20	RW	(IEEE 32 bit)
802A	32810	SIL USER	Composite Velocity Warn High limit - Alarm limits-Normal operation	20	RW	(IEEE 32 bit)
802C	32812	SIL USER	Composite Reference Density for Standard volumetric calculation	4	RW	(IEEE 32 bit)
802E	32814	SERVICE	Composite Base value for frequency output	1, 14, 20	RW	(IEEE 32 bit)
8030	32816	SIL USER	Composite Analog Input Zero Set point as entered into the system by user	8	RW	(IEEE 32 bit)
8032	32818	SIL USER	Composite Analog Input Span Set point as entered into the system by user	8	RW	(IEEE 32 bit)
9000	36864	SERVICE	Composite MultiK VelRey_1	18, 20	RW	(IEEE 32 bit)
9002	36866	SERVICE	Composite MultiK VelRey_2	18, 20	RW	(IEEE 32 bit)
9004	36868	SERVICE	Composite MultiK VelRey_3	18, 20	RW	(IEEE 32 bit)
9006	36870	SERVICE	Composite MultiK VelRey_4	18, 20	RW	(IEEE 32 bit)
9008	36872	SERVICE	Composite MultiK VelRey_5	18, 20	RW	(IEEE 32 bit)
900A	36874	SERVICE	Composite MultiK VelRey_6	18, 20	RW	(IEEE 32 bit)
9400	37888	SERVICE	Composite MultiK KFactor_1	18	RW	(IEEE 32 bit)
9402	37890	SERVICE	Composite MultiK KFactor_2	18	RW	(IEEE 32 bit)
9404	37892	SERVICE	Composite MultiK KFactor_3	18	RW	(IEEE 32 bit)
9406	37894	SERVICE	Composite MultiK KFactor_4	18	RW	(IEEE 32 bit)

Table 10: XMIT Modbus Map (cont.)

Register (in Hex)	Register (in Decimal)	Access Level	Variable	Unit Group	Read Only/Read Write	Format
9408	37896	SERVICE	Composite MultiK KFactor_5	18	RW	(IEEE 32 bit)
940A	37898	SERVICE	Composite MultiK KFactor_6	18	RW	(IEEE 32 bit)
Composite Channel Integer - FF Terminal Block 2						
8100	33024	SERVICE	Composite Reynolds Correction: 0: Off, 1: On	18	RW	INT32
8102	33026	VIEWER	Composite Command to capture a new set of signal files: 0: Write - ERROR, Read - Not Ready, 1: Write - Capture, Read - Ready	18	RW	INT32
8104	33028	SERVICE	Composite Path Configuration: 0: single path diameter, 1: single path mid radius, 2: two path diameter, 3: two path mid radius, 4: three path	18	RW	INT32
8106	33030	FACTORY	Composite Hardware revision	18	RW	INT32
8108	33032	FACTORY	Composite Software revision	18	RW	INT32
810A	33034	FACTORY	Composite UMPU board serial number	18	RW	INT32
810C	33036	VIEWER	Composite Totalizer Command: 0: Batch Reset 1: Batch Start, 2: Batch Stop, 3: Inventory Reset	18	RW	INT32
810E	33038	SERVICE	Composite Command: 0: Off, 1: Commissioned, 2: Factory	18	RW	INT32
8110	33040	SIL USER	Composite Which test to run: 0: None, 1: Watch-dog Test, 2: Open SIL Output switch, 3: Close SIL Output switch	18	RW	INT32
8112	33042	SIL USER	Composite Service	18	RW	INT32
8114	33044	SIL USER	Composite Factory	18	RW	INT32
8116	33046	SIL USER	Composite User	18	RW	INT32
8118	33048	SIL USER	Composite AnalogOut Command (for trim): 0: Trim Off, 1: Low Set, 2: High Set, 3: Zero trim 4: Span trim 5: Percent Set	18	RW	INT32
811A	33050	FACTORY	Composite Sensor serial number 1	18	RW	INT32
811C	33052	FACTORY	Composite Sensor serial number 2	18	RW	INT32
811E	33054	SERVICE	Composite Tracking Windows: 0: Off, 1: On	18	RW	INT32
8120	33056	SERVICE	Composite MultiK Active: 0: Off, 1: On	18	RW	INT32
8122	33058	SERVICE	Composite MultiK Type: 0: Velocity, 1: Reynolds	18	RW	INT32
8124	33060	SERVICE	Composite MultiK Pairs	18	RW	INT32
8126	33062	SERVICE	Composite KV Input Selection	18	RW	INT32
8128	33064	SIL USER	Composite System Command (such as commit, accept, halt): 0: Init, 1: Halt, 2: Cancel, 3: Submit, 4: Commit, 5: Commit as Factory, 6: Commit as Commissioned, 7: Password Change request	18	RW	INT32
812A	33066	SERVICE	Composite Active TW: 0: Disabled, 1: Enabled	18	RW	INT32

Table 10: XMIT Modbus Map (cont.)

Register (in Hex)	Register (in Decimal)	Access Level	Variable	Unit Group	Read Only/Read Write	Format
812C	33068	SIL USER	Composite Selection for FireLow/ Fire High during fault: 0: Fire-Low, 1: Fire-High	18	RW	INT32
812E	33070	SIL USER	Composite Analog Output Selection: 0: Mass Flow, 1: Actual Volumetric, 2: Standard Volumetric	18	RW	INT32
8130	33072	SERVICE	Composite Calibration Mode Selection: 0: Off 1: Gate Input, 2: Frequency Output	18	RW	INT32
8132	33074	SERVICE	Composite Base Frequency for frequency Output	6	RW	INT32
8134	33076	SERVICE	Composite Span Frequency for frequency Output	6	RW	INT32
8136	33078	SERVICE	Composite Frequency Output Unit Selection: 0: Velocity, 1: Volumetric, 2: Mass Flow	18	RW	INT32
8138	33080	SERVICE	Composite Frequency Output Error State Selection: 0: Force Low, 1: Force High, 2: Hold Last	18	RW	INT32
813A	33082	SERVICE	Composite Path Error Handling: 0: Off, 1: On	18	RW	INT32
813C	33084	SIL USER	Composite Unit Type Dimension (see Unit Table, C.2)	18	RW	INT32
813E	33086	SIL USER	Composite Unit Type Density (see Unit Table, C.2)	18	RW	INT32
8140	33088	SIL USER	Composite Unit Type Mass Flow (see Unit Table, C.2)	18	RW	INT32
8142	33090	SIL USER	Composite Unit Type Volumetric (see Unit Table, C.2)	18	RW	INT32
8144	33092	SIL USER	Composite Unit Type Velocity (see Unit Table, C.2)	18	RW	INT32
8146	33094	SERVICE	Composite Test Frequency for Frequency Output	6	RW	INT32
8148	33096	FACTORY	Composite Sensor serial number 3	18	RW	INT32
814A	33098	FACTORY	Composite Sensor serial number 4	18	RW	INT32
814C	33100	FACTORY	Composite Sensor serial number 5	18	RW	INT32
814E	33102	FACTORY	Composite Sensor serial number 6	18	RW	INT32
8150	33104	FACTORY	Composite Flowmeter/System serial number	18	RW	INT32
8152	33106	SIL USER	Composite Unit Type Time (see Unit Table, C.2)	18	RW	INT32
8154	33108	SIL USER	Composite Unit Type Viscosity (see Unit Table, C.2)	18	RW	INT32
8156	33110	SIL USER	Composite Unit Type Standard Volumetric (see Unit Table, C.2)	18	RW	INT32
8158	33112	FACTORY	Composite Standard BWT buffer 1 serial number	18	RW	INT32

Table 10: XMIT Modbus Map (cont.)

Register (in Hex)	Register (in Decimal)	Access Level	Variable	Unit Group	Read Only/Read Write	Format
815A	33114	FACTORY	Composite Standard BWT buffer 2 serial number	18	RW	INT32
815C	33116	FACTORY	Composite Standard BWT buffer 3 serial number	18	RW	INT32
815E	33118	FACTORY	Composite Standard BWT buffer 4 serial number	18	RW	INT32
8160	33120	FACTORY	Composite Standard BWT buffer 5 serial number	18	RW	INT32
8162	33122	FACTORY	Composite Standard BWT buffer 6 serial number	18	RW	INT32
8164	33124	FACTORY	Composite UMPU receiver serial number	18	RW	INT32
Channel 1 Real – FF Terminal Block 4						
8400	33792	SERVICE	Ch_1 Chord Wt factor	18	RW	(IEEE 32 bit)
8402	33794	SERVICE	Ch_1 Time Buffer Offset	19	RW	(IEEE 32 bit)
8404	33796	SERVICE	Ch_1 Time in wedge	19	RW	(IEEE 32 bit)
8406	33798	SERVICE	Ch_1 Path Length P	5	RW	(IEEE 32 bit)
8408	33800	SERVICE	Ch_1 Axial Length L	5	RW	(IEEE 32 bit)
840A	33802	SERVICE	Ch_1 delay between successive transmits	19	RW	(IEEE 32 bit)
840C	33804	SERVICE	Ch_1 DeltaT Offset	19	RW	(IEEE 32 bit)
Channel 1 Integer – FF Terminal Block 4						
8500	34048	SERVICE	Ch_1 Pct of Peak	12	RW	INT32
8502	34050	SERVICE	Ch_1 Min Peak%	12	RW	INT32
8504	34052	SERVICE	Ch_1 Max Peak%	12	RW	INT32
8506	34054	SERVICE	Ch_1 Reynolds correction selection: 0: Off, 1: On	18	RW	INT32
8508	34056	SERVICE	Ch_1 enum of transducer type (ex. T5): 0: BWT	18	RW	INT32
850A	34058	SERVICE	Ch_1 Transducer Freq: 500000: 500kHz, 1000000: 1MHz	6	RW	INT32
850C	34060	SERVICE	Ch 1 Errors Allowed	18	RW	INT32
Channel 2 Real – FF Terminal Block 5						
8800	34816	SERVICE	Ch_2 Composite Coefficient	18	RW	(IEEE 32 bit)
8802	34818	SERVICE	Ch_2 Time Buffer Offset	19	RW	(IEEE 32 bit)
8804	34820	SERVICE	Ch_2 Time in wedge	19	RW	(IEEE 32 bit)
8806	34822	SERVICE	Ch_2 Path Length P	5	RW	(IEEE 32 bit)
8808	34824	SERVICE	Ch_2 Axial Length L	5	RW	(IEEE 32 bit)
880A	34826	SERVICE	Ch_2 delay between successive transmits	19	RW	(IEEE 32 bit)
880C	34828	SERVICE	Ch_2 DeltaT Offset	19	RW	(IEEE 32 bit)
Channel 2 Integer – FF Terminal Block 5						
8900	35072	SERVICE	Ch_2 Pct of Peak	12	RW	INT32

Table 10: XMIT Modbus Map (cont.)

Register (in Hex)	Register (in Decimal)	Access Level	Variable	Unit Group	Read Only/Read Write	Format
8902	35074	SERVICE	Ch_2 Min Peak%	12	RW	INT32
8904	35076	SERVICE	Ch_2 Max Peak%	12	RW	INT32
8906	35078	SERVICE	Ch_2 Reynolds correction selection: 0: Off, 1: On	18	RW	INT32
8908	35080	SERVICE	Ch_2 enum of transducer type (ex. T5): 0: BWT	18	RW	INT32
890A	35082	SERVICE	Ch_2 Transducer Freq: 500000: 500kHz, 1000000: 1MHz	6	RW	INT32
890C	35084	SERVICE	Ch_2 Errors Allowed	18	RW	INT32

Measurements (Input Registers)

Composite Channel Real

8200	33280	VIEWER	Composite Velocity	20	RO	(IEEE 32 bit)
8202	33282	VIEWER	Composite Volumetric	1	RO	(IEEE 32 bit)
8204	33284	VIEWER	Composite Mass Flow	9	RO	(IEEE 32 bit)
8206	33286	VIEWER	Composite Fwd Batch Totals	17	RO	(IEEE 32 bit)
8208	33288	VIEWER	Composite Rev Batch Totals	17	RO	(IEEE 32 bit)
820A	33290	VIEWER	Composite Totalizer Time	16	RO	(IEEE 32 bit)
820C	33292	VIEWER	Composite Sound Speed	20	RO	(IEEE 32 bit)
8214	33300	VIEWER	Composite Current Correction Factor	18	RO	(IEEE 32 bit)
8216	33302	VIEWER	Composite Current Reynolds Number	18	RO	(IEEE 32 bit)
8218	33304	VIEWER	Composite Current operating temperature read from temperature sensor	15	RO	(IEEE 32 bit)
821A	33306	VIEWER	Composite Standard Volumetric	14	RO	(IEEE 32 bit)
821C	33308	VIEWER	Composite Net Batch Totals	17	RO	(IEEE 32 bit)
8220	33312	VIEWER	Composite SIL Analog Out Drive Current	8	RO	(IEEE 32 bit)
8222	33314	VIEWER	Composite SIL Analog Out Monitored Current	8	RO	(IEEE 32 bit)

Composite Channel Int

8300	33536	VIEWER	Composite status bit map	18	RO	INT32
8302	33538	VIEWER	Composite SIL errors: epSIL_Value_Health_Code_!: Use dropdown	18	RO	INT32
8304	33540	VIEWER	Composite most significant error (see Error Tables)	18	RO	INT32
8306	33542	VIEWER	Composite Gate Input State bitmap: 0: Open, 1: Closed	18	RO	INT32

Channel 1 Real – FF Terminal Block 4

8600	34304	VIEWER	Ch_1 Velocity	20	RO	(IEEE 32 bit)
8602	34306	VIEWER	Ch_1 Sound Speed	20	RO	(IEEE 32 bit)
8604	34308	VIEWER	Ch_1 Transit Time Up	19	RO	(IEEE 32 bit)
8606	34310	VIEWER	Ch_1 Transit Time Dn	19	RO	(IEEE 32 bit)

Table 10: XMIT Modbus Map (cont.)

Register (in Hex)	Register (in Decimal)	Access Level	Variable	Unit Group	Read Only/Read Write	Format
8608	34312	VIEWER	Ch_1 DeltaT	19	RO	(IEEE 32 bit)
860A	34314	VIEWER	Ch_1 Time in buffer on Dn channel	19	RO	(IEEE 32 bit)
860C	34316	VIEWER	Ch_1 Up Signal Quality	18	RO	(IEEE 32 bit)
860E	34318	VIEWER	Ch_1 Dn Signal Quality	18	RO	(IEEE 32 bit)
8610	34320	VIEWER	Ch_1 Up Amp Disc	18	RO	(IEEE 32 bit)
8612	34322	VIEWER	Ch_1 Dn Amp Disc	18	RO	(IEEE 32 bit)
8614	34324	VIEWER	Ch_1 Signal Gain Up	3	RO	(IEEE 32 bit)
8616	34326	VIEWER	Ch_1 Signal Gain Down	3	RO	(IEEE 32 bit)
8618	34328	VIEWER	Ch_1_SNR on UP channel	18	RO	(IEEE 32 bit)
861A	34330	VIEWER	Ch_1_SNR on DOWN channel	18	RO	(IEEE 32 bit)
861C	34332	VIEWER	Ch_1 Time in buffer on Up channel	19	RO	(IEEE 32 bit)
Channel 1 Integer - FF Terminal Block 4						
8700	34560	VIEWER	Ch_1 status bit map	18	RO	INT32
8702	34562	VIEWER	Ch_1 most significant error (see Error Tables)	18	RO	INT32
8704	34564	VIEWER	Ch_1 Up +- Peak	18	RO	INT32
8706	34566	VIEWER	Ch_1 Dn +- Peak	18	RO	INT32
8708	34568	VIEWER	Ch_1 dynamic threshold on UP channel	12	RO	INT32
870A	34570	VIEWER	Ch_1 dynamic threshold on DOWN channel	12	RO	INT32
870C	34572	VIEWER	Ch_1 #Errors of Last 16	18	RO	INT32
Channel 2 Real - FF Terminal Block 5						
8A00	35328	VIEWER	Ch_2 Velocity	20	RO	(IEEE 32 bit)
8A02	35330	VIEWER	Ch_2 Sound Speed	20	RO	(IEEE 32 bit)
8A04	35332	VIEWER	Ch_2 Transit Time Up	19	RO	(IEEE 32 bit)
8A06	35334	VIEWER	Ch_2 Transit Time Dn	19	RO	(IEEE 32 bit)
8A08	35336	VIEWER	Ch_2 DeltaT	19	RO	(IEEE 32 bit)
8A0A	35338	VIEWER	Ch_2 Time in buffer on Dn channel	19	RO	(IEEE 32 bit)
8A0C	35340	VIEWER	Ch_2 Up Signal Quality	18	RO	(IEEE 32 bit)
8A0E	35342	VIEWER	Ch_2 Dn Signal Quality	18	RO	(IEEE 32 bit)
8A10	35344	VIEWER	Ch_2 Up Amp Disc	18	RO	(IEEE 32 bit)
8A12	35346	VIEWER	Ch_2 Dn Amp Disc	18	RO	(IEEE 32 bit)
8A14	35348	VIEWER	Ch_2 Signal Gain Up	3	RO	(IEEE 32 bit)
8A16	35350	VIEWER	Ch_2 Signal Gain Down	3	RO	(IEEE 32 bit)
8A18	35352	VIEWER	Ch_2_SNR on UP channel	18	RO	(IEEE 32 bit)
8A1A	35354	VIEWER	Ch_2_SNR on DOWN channel	18	RO	(IEEE 32 bit)
8A1C	35356	VIEWER	Ch_2 Time in buffer on Up channel	19	RO	(IEEE 32 bit)
Channel 2 Integer - FF Terminal Block 5						
8B00	35584	VIEWER	Ch_2 status bit map	18	RO	INT32
8B02	35586	VIEWER	Ch_2 most significant error (see Error Tables)	18	RO	INT32

Table 10: XMIT Modbus Map (cont.)

Register (in Hex)	Register (in Decimal)	Access Level	Variable	Unit Group	Read Only/Read Write	Format
8B04	35588	VIEWER	Ch_2 Up +- Peak	18	RO	INT32
8B06	35590	VIEWER	Ch_2 Dn +- Peak	18	RO	INT32
8B08	35592	VIEWER	Ch_2 dynamic threshold on UP channel	12	RO	INT32
8B0A	35594	VIEWER	Ch_2 dynamic threshold on DOWN channel	12	RO	INT32
8B0C	35596	VIEWER	Ch_2 # Errors of Last 16	18	RO	INT32
Composite Channel Real Max						
A200	41472	VIEWER	Maximum Composite Velocity	20	RO	(IEEE 32 bit)
A202	41474	VIEWER	Maximum Composite Volumetric	1	RO	(IEEE 32 bit)
A204	41476	VIEWER	Maximum Composite Mass Flow	9	RO	(IEEE 32 bit)
A206	41478	VIEWER	Maximum Composite Fwd Batch Totals	17	RO	(IEEE 32 bit)
A208	41480	VIEWER	Maximum Composite Rev Batch Totals	17	RO	(IEEE 32 bit)
A20A	41482	VIEWER	Maximum Composite Totalizer Time	2	RO	(IEEE 32 bit)
A20C	41484	VIEWER	Maximum Composite Sound Speed	20	RO	(IEEE 32 bit)
A20E	41486	VIEWER	Maximum Composite Inventory Fwd Totals	17	RO	(IEEE 32 bit)
A210	41488	VIEWER	Maximum Composite Inventory Rev Totals	17	RO	(IEEE 32 bit)
A212	41490	VIEWER	Maximum Composite Inventory Totalizer Time	2	RO	(IEEE 32 bit)
A214	41492	VIEWER	Maximum Composite Current Correction Factor	18	RO	(IEEE 32 bit)
A216	41494	VIEWER	Maximum Composite Current Reynolds Number	18	RO	(IEEE 32 bit)
A218	41496	VIEWER	Maximum Composite acceptable operating temperature reading from temperature sensor	15	RO	(IEEE 32 bit)
A21A	41498	VIEWER	Maximum Composite Standard Volumetric	14	RO	(IEEE 32 bit)
A21C	41500	VIEWER	Maximum Composite Net Batch Totals	17	RO	(IEEE 32 bit)
A21E	41502	VIEWER	Maximum Composite Net Inventory Totals	17	RO	(IEEE 32 bit)
A220	41504	VIEWER	Maximum Composite SIL Analog Out Drive Current	8	RO	(IEEE 32 bit)
A222	41506	VIEWER	Maximum Composite SIL Analog Out Monitored Current	8	RO	(IEEE 32 bit)
Composite Channel Integer Max						
A300	41728	VIEWER	Maximum Composite status bit map	18	RO	INT32
A302	41730	VIEWER	Maximum Composite SIL errors	18	RO	INT32
A304	41732	VIEWER	Maximum Composite most significant error	18	RO	INT32
A306	41734	VIEWER	Maximum Composite Gate Input State bitmap: 0: Open, 1: Closed	18	RO	INT32

Table 10: XMIT Modbus Map (cont.)

Register (in Hex)	Register (in Decimal)	Access Level	Variable	Unit Group	Read Only/ Read Write	Format
Composite Channel Real Min						
A600	42496	VIEWER	Minimum Composite Velocity	20	RO	(IEEE 32 bit)
A602	42498	VIEWER	Minimum Composite Volumetric	1	RO	(IEEE 32 bit)
A604	42500	VIEWER	Minimum Composite Mass Flow	9	RO	(IEEE 32 bit)
A606	42502	VIEWER	Minimum Composite Fwd Batch Totals	17	RO	(IEEE 32 bit)
A608	42504	VIEWER	Minimum Composite Rev Batch Totals	17	RO	(IEEE 32 bit)
A60A	42506	VIEWER	Minimum Composite Totalizer Time	16	RO	(IEEE 32 bit)
A60C	42508	VIEWER	Minimum Composite Sound Speed	20	RO	(IEEE 32 bit)
A60E	42510	VIEWER	Minimum Composite Inventory Fwd Totals	17	RO	(IEEE 32 bit)
A610	42512	VIEWER	Minimum Composite Inventory Rev Totals	17	RO	(IEEE 32 bit)
A612	42514	VIEWER	Minimum Composite Inventory Totalizer Time	2	RO	(IEEE 32 bit)
A614	42516	VIEWER	Minimum Composite Current Correction Factor	18	RO	(IEEE 32 bit)
A616	42518	VIEWER	Minimum Composite Current Reynolds Number	18	RO	(IEEE 32 bit)
A618	42520	VIEWER	Minimum Composite acceptable operating temperature reading from temperature sensor	15	RO	(IEEE 32 bit)
A61A	42522	VIEWER	Minimum Composite Standard Volumetric	14	RO	(IEEE 32 bit)
A61C	42524	VIEWER	Minimum Composite Net Batch Totals	17	RO	(IEEE 32 bit)
A61E	42526	VIEWER	Minimum Composite Net Inventory Totals	17	RO	(IEEE 32 bit)
A620	42528	VIEWER	Minimum Composite SIL Analog Out Drive Current	8	RO	(IEEE 32 bit)
A622	42530	VIEWER	Minimum Composite SIL Analog Out Monitored Current	8	RO	(IEEE 32 bit)
Composite Channel Integer Min						
A700	42752	VIEWER	Minimum Composite status bit map	18	RO	INT32
A702	42754	VIEWER	Minimum Composite SIL errors	18	RO	INT32
A704	42756	VIEWER	Minimum Composite most significant error	18	RO	INT32
A706	42758	VIEWER	Minimum Composite Gate Input State bit-map: 0: Open, 1: Closed	18	RO	INT32
Composite Channel Real Max						
A000	40960	VIEWER	Maximum Composite Frequency Output Span Value	1, 14, 20	RO	(IEEE 32 bit)
A002	40962	VIEWER	Maximum Composite Pipe Inner Diameter	5	RO	(IEEE 32 bit)
A004	40964	VIEWER	Maximum Composite Pipe Outer Diameter	5	RO	(IEEE 32 bit)

Table 10: XMIT Modbus Map (cont.)

Register (in Hex)	Register (in Decimal)	Access Level	Variable	Unit Group	Read Only/ Read Write	Format
A006	40966	VIEWER	Maximum Composite Pipe Wall Thickness	5	RO	(IEEE 32 bit)
A008	40968	VIEWER	Maximum Composite Velocity Warn High limit - Alarm limits- Normal operation	20	RO	(IEEE 32 bit)
A00A	40970	VIEWER	Maximum Composite Analog out percent scale	12	RO	(IEEE 32 bit)
A00C	40972	VIEWER	Maximum Composite Static Density	4	RO	(IEEE 32 bit)
A00E	40974	VIEWER	Maximum Composite Acceleration Limit	18	RO	(IEEE 32 bit)
A010	40976	VIEWER	Maximum Composite Amplitude discriminator min limit	18	RO	(IEEE 32 bit)
A012	40978	VIEWER	Maximum Composite Amplitude discriminator max limit	18	RO	(IEEE 32 bit)
A014	40980	VIEWER	Maximum Composite Kinematic Viscosity	7	RO	(IEEE 32 bit)
A016	40982	VIEWER	Maximum Composite Calibration Factor	18	RO	(IEEE 32 bit)
A018	40984	VIEWER	Maximum Composite Zero Cutoff	20	RO	(IEEE 32 bit)
A01A	40986	VIEWER	Maximum Composite Response Time	13	RO	(IEEE 32 bit)
A01C	40988	VIEWER	Maximum Composite Analog Output Low Limit point as entered in the system	1, 9, 14	RO	(IEEE 32 bit)
A01E	40990	VIEWER	Maximum Composite Analog Output High Limit as entered in the system	1, 9, 14	RO	(IEEE 32 bit)
A020	40992	VIEWER	Maximum Composite Zero Set point as entered into the system by user	8	RO	(IEEE 32 bit)
A022	40994	VIEWER	Maximum Composite Span Set point as entered into the system by user	8	RO	(IEEE 32 bit)
A024	40996	VIEWER	Maximum Composite Velocity Low limit	20	RO	(IEEE 32 bit)
A026	40998	VIEWER	Maximum Composite Velocity High limit	20	RO	(IEEE 32 bit)
A028	41000	VIEWER	Maximum Composite Velocity Warning Low limit	20	RO	(IEEE 32 bit)
A02A	41002	VIEWER	Maximum Composite Velocity Warning High limit	20	RO	(IEEE 32 bit)
A02C	41004	VIEWER	Maximum Composite Reference Density	4	RO	(IEEE 32 bit)
A02E	41006	VIEWER	Maximum Composite Frequency Output Base Value	1, 14, 20	RO	(IEEE 32 bit)
A030	41008	VIEWER	Maximum Composite Analog Input Zero Set point as entered into the system by user	8	RO	(IEEE 32 bit)
A032	41010	VIEWER	Maximum Composite Analog Input Span Set point as entered into the system by user	8	RO	(IEEE 32 bit)
A034	41012	VIEWER	Maximum Composite VelRey individual value	18, 20	RO	(IEEE 32 bit)

Table 10: XMIT Modbus Map (cont.)

Register (in Hex)	Register (in Decimal)	Access Level	Variable	Unit Group	Read Only/Read Write	Format
A036	41014	VIEWER	Maximum Composite KFact individual value	18	RO	(IEEE 32 bit)
Composite Channel Integer Max						
A100	41216	VIEWER	Maximum Composite Reynolds Correction	18	RO	INT32
A102	41218	VIEWER	Maximum Command to capture a new set of signal files	18	RO	INT32
A104	41220	VIEWER	Maximum Composite Path Configuration	18	RO	INT32
A106	41222	VIEWER	Maximum Composite Hardware revision	18	RO	INT32
A108	41224	VIEWER	Maximum Composite Software revision	18	RO	INT32
A10A	41226	VIEWER	Maximum Composite UMPU board serial number	18	RO	INT32
A10C	41228	VIEWER	Maximum Composite max range of command	18	RO	INT32
A10E	41230	VIEWER	Maximum Composite Command	18	RO	INT32
A110	41232	VIEWER	Maximum Composite Which test to run	18	RO	INT32
A112	41234	VIEWER	Maximum Composite Service	18	RO	INT32
A114	41236	VIEWER	Maximum Composite Factory	18	RO	INT32
A116	41238	VIEWER	Maximum Composite User	18	RO	INT32
A118	41240	VIEWER	Maximum Composite AnalogOut Command (for trim)	18	RO	INT32
A11A	41242	VIEWER	Maximum Composite Sensor serial number 1	18	RO	INT32
A11C	41244	VIEWER	Maximum Composite Sensor serial number 2	18	RO	INT32
A11E	41246	VIEWER	Maximum Composite Tracking Windows	18	RO	INT32
A120	41248	VIEWER	Maximum Composite MultiK Active	18	RO	INT32
A122	41250	VIEWER	Maximum Composite MultiK Type	18	RO	INT32
A124	41252	VIEWER	Maximum Composite MultiK Pairs	18	RO	INT32
A126	41254	VIEWER	Maximum Composite KV Input Selection	18	RO	INT32
A128	41256	VIEWER	Maximum Composite System Command (such as commit, accept, halt)	18	RO	INT32
A12A	41258	VIEWER	Maximum Composite Enable Active TW	18	RO	INT32
A12C	41260	VIEWER	Maximum Composite FireLow/ Fire High during fault	18	RO	INT32
A12E	41262	VIEWER	Maximum Composite Analog output selection	18	RO	INT32
A130	41264	VIEWER	Maximum Composite Calibration Mode Selection	18	RO	INT32
A132	41266	VIEWER	Maximum Composite Base Frequency for frequency Output	6	RO	INT32
A134	41268	VIEWER	Maximum Composite Span Frequency for frequency Output	6	RO	INT32

Table 10: XMIT Modbus Map (cont.)

Register (in Hex)	Register (in Decimal)	Access Level	Variable	Unit Group	Read Only/Read Write	Format
A136	41270	VIEWER	Maximum Composite Frequency Output Unit Selection	18	RO	INT32
A138	41272	VIEWER	Maximum Composite Frequency Output Error State Selection	18	RO	INT32
A13A	41274	VIEWER	Maximum Composite Path Error Handling	18	RO	INT32
A13C	41276	VIEWER	Maximum Composite Unit Type Dimension	18	RO	INT32
A13E	41278	VIEWER	Maximum Composite Unit Type Density	18	RO	INT32
A140	41280	VIEWER	Maximum Composite Unit Type Mass Flow	18	RO	INT32
A142	41282	VIEWER	Maximum Composite Unit Type Volumetric	18	RO	INT32
A144	41284	VIEWER	Maximum Composite Unit Type Velocity	18	RO	INT32
A146	41286	VIEWER	Maximum Composite test frequency for frequency output	6	RO	INT32
A148	41288	VIEWER	Maximum Composite Sensor serial number 3	18	RO	INT32
A14A	41290	VIEWER	Maximum Composite Sensor serial number 4	18	RO	INT32
A14C	41292	VIEWER	Maximum Composite Sensor serial number 5	18	RO	INT32
A14E	41294	VIEWER	Maximum Composite Sensor serial number 6	18	RO	INT32
A150	41296	VIEWER	Maximum Composite Flowmeter/System serial number	18	RO	INT32
A152	41298	VIEWER	Maximum Composite Unit Type Time	18	RO	INT32
A154	41300	VIEWER	Maximum Composite Unit Type Viscosity	18	RO	INT32
A156	41302	VIEWER	Maximum Composite Unit Type Standard Volumetric	18	RO	INT32
A158	41304	VIEWER	Maximum Composite Standard BWT buffer 1 serial number	18	RO	INT32
A15A	41306	VIEWER	Maximum Composite Standard BWT buffer 2 serial number	18	RO	INT32
A15C	41308	VIEWER	Maximum Composite Standard BWT buffer 3 serial number	18	RO	INT32
A15E	41310	VIEWER	Maximum Composite Standard BWT buffer 4 serial number	18	RO	INT32
A160	41312	VIEWER	Maximum Composite Standard BWT buffer 5 serial number	18	RO	INT32
A162	41314	VIEWER	Maximum Composite Standard BWT buffer 6 serial number	18	RO	INT32
A164	41316	VIEWER	Maximum Composite UMPU receiver serial number	18	RO	INT32

Table 10: XMIT Modbus Map (cont.)

Register (in Hex)	Register (in Decimal)	Access Level	Variable	Unit Group	Read Only/Read Write	Format
Composite Channel Real Min						
A400	41984	VIEWER	Minimum Composite Velocity Warn High limit - Alarm limits- Normal operation	1, 9, 20	RO	(IEEE 32 bit)
A402	41986	VIEWER	Minimum Composite Pipe Inner Diameter	5	RO	(IEEE 32 bit)
A404	41988	VIEWER	Minimum Composite Pipe Outer Diameter	5	RO	(IEEE 32 bit)
A406	41990	VIEWER	Minimum Composite Pipe Wall Thickness	5	RO	(IEEE 32 bit)
A408	41992	VIEWER	Minimum Composite Velocity Warn High limit - Alarm limits- Normal operation	20	RO	(IEEE 32 bit)
A40A	41994	VIEWER	Minimum Composite Analog out percent scale	12	RO	(IEEE 32 bit)
A40C	41996	VIEWER	Minimum Composite Static Density	4	RO	(IEEE 32 bit)
A40E	41998	VIEWER	Minimum Composite Acceleration Limit		RO	(IEEE 32 bit)
A410	42000	VIEWER	Minimum Composite Amplitude discriminator min limit	18	RO	(IEEE 32 bit)
A412	42002	VIEWER	Minimum Composite Amplitude discriminator max limit	18	RO	(IEEE 32 bit)
A414	42004	VIEWER	Minimum Composite Kinematic Viscosity	7	RO	(IEEE 32 bit)
A416	42006	VIEWER	Minimum Composite Calibration Factor	18	RO	(IEEE 32 bit)
A418	42008	VIEWER	Minimum Composite Zero Cutoff	20	RO	(IEEE 32 bit)
A41A	42010	VIEWER	Minimum Composite Response Time	13	RO	(IEEE 32 bit)
A41C	42012	VIEWER	Minimum Composite Analog Output Low Limit point as entered in the system	1, 9, 14	RO	(IEEE 32 bit)
A41E	42014	VIEWER	Minimum Composite Analog Output High Limit as entered in the system	1, 9, 14	RO	(IEEE 32 bit)
A420	42016	VIEWER	Minimum Composite Zero Set point as entered into the system by user	8	RO	(IEEE 32 bit)
A422	42018	VIEWER	Minimum Composite Span Set point as entered into the system by user	8	RO	(IEEE 32 bit)
A424	42020	VIEWER	Minimum Composite Velocity Low limit Min	20	RO	(IEEE 32 bit)
A426	42022	VIEWER	Minimum Composite Velocity High limit Min	20	RO	(IEEE 32 bit)
A428	42024	VIEWER	Minimum Composite Velocity Warning Low limit Min	20	RO	(IEEE 32 bit)
A42A	42026	VIEWER	Minimum Composite Velocity Warning High limit Min	20	RO	(IEEE 32 bit)
A42C	42028	VIEWER	Minimum Composite Static Density	4	RO	(IEEE 32 bit)
A42E	42030	VIEWER	Minimum Composite Velocity Warn High limit - Alarm limits- Normal operation	1, 14, 20	RO	(IEEE 32 bit)

Table 10: XMIT Modbus Map (cont.)

Register (in Hex)	Register (in Decimal)	Access Level	Variable	Unit Group	Read Only/ Read Write	Format
A430	42032	VIEWER	Minimum Composite Analog Input Zero Set point as entered into the system by user	8	RO	(IEEE 32 bit)
A432	42034	VIEWER	Minimum Composite Analog Input Span Set point as entered into the system by user	8	RO	(IEEE 32 bit)
A434	42036	VIEWER	Minimum Composite VelRey individual value	18, 20	RO	(IEEE 32 bit)
A436	42038	VIEWER	Minimum Composite KFact individual value	18	RO	(IEEE 32 bit)
Composite Channel Integer Min						
A500	42240	VIEWER	Minimum Composite Reynolds Correction	18	RO	INT32
A502	42242	VIEWER	Minimum Command to capture a new set of signal files	18	RO	INT32
A504	42244	VIEWER	Minimum Composite Path Configuration	18	RO	INT32
A506	42246	VIEWER	Minimum Composite Hardware revision	18	RO	INT32
A508	42248	VIEWER	Minimum Composite Software revision	18	RO	INT32
A50A	42250	VIEWER	Minimum Composite UMPU board serial number	18	RO	INT32
A50C	42252	VIEWER	Minimum Composite Ceiling of the absolute value of correlation	18	RO	INT32
A50E	42254	VIEWER	Minimum Composite Command	18	RO	INT32
A510	42256	VIEWER	Minimum Composite Which test to run	18	RO	INT32
A512	42258	VIEWER	Minimum Composite Service Password	18	RO	INT32
A514	42260	VIEWER	Minimum Composite Factory Password	18	RO	INT32
A516	42262	VIEWER	Minimum Composite User Password	18	RO	INT32
A518	42264	VIEWER	Minimum Composite AnalogOut Command (for trim)	18	RO	INT32
A51A	42266	VIEWER	Minimum Composite Sensor serial number 1	18	RO	INT32
A51C	42268	VIEWER	Minimum Composite Sensor serial number 2	18	RO	INT32
A51E	42270	VIEWER	Minimum Composite Tracking Windows	18	RO	INT32
A520	42272	VIEWER	Minimum Composite MultiK Active	18	RO	INT32
A522	42274	VIEWER	Minimum Composite MultiK Type	18	RO	INT32
A524	42276	VIEWER	Minimum Composite MultiK Pairs	18	RO	INT32
A526	42278	VIEWER	Minimum Composite KV Input Selection	18	RO	INT32
A528	42280	VIEWER	Minimum Composite System Command (such as commit, accept, halt)	18	RO	INT32
A52A	42282	VIEWER	Minimum Composite Enable Active TW	18	RO	INT32
A52C	42284	VIEWER	Minimum Composite FireLow/ Fire High during fault	18	RO	INT32
A52E	42286	VIEWER	Minimum Composite Analog output selection	18	RO	INT32

Table 10: XMIT Modbus Map (cont.)

Register (in Hex)	Register (in Decimal)	Access Level	Variable	Unit Group	Read Only/Read Write	Format
A530	42288	VIEWER	Minimum Composite Calibration mode selection: 0:	18	RO	INT32
A532	42290	VIEWER	Minimum Composite Base Frequency for frequency	6	RO	INT32
A534	42292	VIEWER	Minimum Composite Span Frequency for frequency	6	RO	INT32
A536	42294	VIEWER	Minimum Composite Frequency Output Unit	18	RO	INT32
A538	42296	VIEWER	Minimum Composite Frequency Output Error State	18	RO	INT32
A53A	42298	VIEWER	Minimum Composite Path Error Handling	18	RO	INT32
A53C	42300	VIEWER	Minimum Composite Unit Type Dimension	18	RO	INT32
A53E	42302	VIEWER	Minimum Composite Unit Type Density	18	RO	INT32
A540	42304	VIEWER	Minimum Composite Unit Type Mass Flow	18	RO	INT32
A542	42306	VIEWER	Minimum Composite Unit Type Volumetric	18	RO	INT32
A544	42308	VIEWER	Minimum Composite Unit Type Velocity	18	RO	INT32
A546	42310	VIEWER	Minimum Composite test frequency for frequency output	6	RO	INT32
A548	42312	VIEWER	Minimum Composite Sensor serial number 3	18	RO	INT32
A54A	42314	VIEWER	Minimum Composite Sensor serial number 4	18	RO	INT32
A54C	42316	VIEWER	Minimum Composite Sensor serial number 5	18	RO	INT32
A54E	42318	VIEWER	Minimum Composite Sensor serial number 6	18	RO	INT32
A550	42320	VIEWER	Minimum Composite Flowmeter/System serial number	18	RO	INT32
A552	42322	VIEWER	Minimum Composite Unit Type Time	18	RO	INT32
A554	42324	VIEWER	Minimum Composite Unit Type Viscosity	18	RO	INT32
A556	42326	VIEWER	Minimum Composite Unit Type Standard Volumetric	18	RO	INT32
A558	42328	VIEWER	Minimum Composite Standard BWT buffer 1 serial number	18	RO	INT32
A55A	42330	VIEWER	Minimum Composite Standard BWT buffer 2 serial number	18	RO	INT32
A55C	42332	VIEWER	Minimum Composite Standard BWT buffer 3 serial number	18	RO	INT32
A55E	42334	VIEWER	Minimum Composite Standard BWT buffer 4 serial number	18	RO	INT32
A560	42336	VIEWER	Minimum Composite Standard BWT buffer 5 serial number	18	RO	INT32
A562	42338	VIEWER	Minimum Composite Standard BWT buffer 6 serial number	18	RO	INT32
A564	42340	VIEWER	Minimum UMPU receiver serial number	18	RO	INT32

Table 10: XMIT Modbus Map (cont.)

Register (in Hex)	Register (in Decimal)	Access Level	Variable	Unit Group	Read Only/Read Write	Format
CH Real Max						
A800	43008	VIEWER	Maximum Channel Composite Coefficient	18	RO	(IEEE 32 bit)
A802	43010	VIEWER	Maximum Channel Time Buffer Offset	19	RO	(IEEE 32 bit)
A804	43012	VIEWER	Maximum Channel Time in Wedge	19	RO	(IEEE 32 bit)
A806	43014	VIEWER	Maximum Channel Path Length P	5	RO	(IEEE 32 bit)
A808	43016	VIEWER	Maximum Channel Axial Length L	5	RO	(IEEE 32 bit)
A80A	43018	VIEWER	Maximum Channel delay between successive transmits	19	RO	(IEEE 32 bit)
A80C	43020	VIEWER	Maximum Channel DeltaT Offset	19	RO	(IEEE 32 bit)
CH Integer Max						
A900	43264	VIEWER	Maximum Channel Pct of Peak	12	RO	INT32
A902	43266	VIEWER	Maximum Channel Min Peak%	12	RO	INT32
A904	43268	VIEWER	Maximum Channel Max Peak%	12	RO	INT32
A906	43270	VIEWER	Maximum Channel Reynolds correction selection	18	RO	INT32
A908	43272	VIEWER	Maximum Channel enum of transducer type (ex. T5)	18	RO	INT32
A90A	43274	VIEWER	Maximum Channel Transducer Freq	6	RO	INT32
A90C	43276	VIEWER	Maximum Channel Errors Allowed	18	RO	INT32
CH Real Min						
AC00	44032	VIEWER	Minimum Channel Composite Coefficient	18	RO	(IEEE 32 bit)
AC02	44034	VIEWER	Minimum Channel Time Buffer Offset	19	RO	(IEEE 32 bit)
AC04	44036	VIEWER	Minimum Channel Time in Wedge	19	RO	(IEEE 32 bit)
AC06	44038	VIEWER	Minimum Channel Path Length P	5	RO	(IEEE 32 bit)
AC08	44040	VIEWER	Minimum Channel Axial Length L	5	RO	(IEEE 32 bit)
AC0A	44042	VIEWER	Minimum Channel delay between successive transmits	19	RO	(IEEE 32 bit)
AC0C	44044	VIEWER	Minimum Channel DeltaT Offset	19	RO	(IEEE 32 bit)
CH Integer Min						
AD00	44288	VIEWER	Minimum Channel Pct of Peak	12	RO	INT32
AD02	44290	VIEWER	Minimum Channel Min Peak%	12	RO	INT32
AD04	44292	VIEWER	Minimum Channel Max Peak%	12	RO	INT32
AD06	44294	VIEWER	Minimum Channel Reynolds correction selection	18	RO	INT32
AD08	44296	VIEWER	Minimum Channel enum of transducer type (ex. T5)	18	RO	INT32
AD0A	44298	VIEWER	Minimum Channel Transducer Freq	6	RO	INT32
AD0C	44300	VIEWER	Minimum Channel Errors Allowed	18	RO	INT32
CH Real Max						
AA00	43520	VIEWER	Maximum Channel Velocity	20	RO	(IEEE 32 bit)

Table 10: XMIT Modbus Map (cont.)

Register (in Hex)	Register (in Decimal)	Access Level	Variable	Unit Group	Read Only/ Read Write	Format
AA02	43522	VIEWER	Maximum Channel Sound Speed	20	RO	(IEEE 32 bit)
AA04	43524	VIEWER	Maximum Channel Transit Time Up	19	RO	(IEEE 32 bit)
AA06	43526	VIEWER	Maximum Channel Transit Time Dn	19	RO	(IEEE 32 bit)
AA08	43528	VIEWER	Maximum Channel DeltaT	19	RO	(IEEE 32 bit)
AA0A	43530	VIEWER	Maximum Channel Time in buffer on DOWN channel	19	RO	(IEEE 32 bit)
AA0C	43532	VIEWER	Maximum Channel Up Signal Quality	18	RO	(IEEE 32 bit)
AA0E	43534	VIEWER	Maximum Channel Dn Signal Quality	18	RO	(IEEE 32 bit)
AA10	43536	VIEWER	Maximum Channel Up Amp Disc	18	RO	(IEEE 32 bit)
AA12	43538	VIEWER	Maximum Channel Dn Amp Disc	18	RO	(IEEE 32 bit)
AA14	43540	VIEWER	Maximum Channel Signal Gain Up	3	RO	(IEEE 32 bit)
AA16	43542	VIEWER	Maximum Channel Signal Gain Down	3	RO	(IEEE 32 bit)
AA18	43544	VIEWER	Maximum Channel_SNR on UP channel	18	RO	(IEEE 32 bit)
AA1A	43546	VIEWER	Maximum Channel_SNR on DOWN channel	18	RO	(IEEE 32 bit)
AA1C	43548	VIEWER	Maximum Channel Time in buffer on UP channel	19	RO	(IEEE 32 bit)
CH Integer Max						
AB00	43776	VIEWER	Maximum Channel status bit map	18	RO	INT32
AB02	43778	VIEWER	Maximum Channel Up +- Peak	18	RO	INT32
AB04	43780	VIEWER	Maximum Channel Dn +- Peak	18	RO	INT32
AB06	43782	VIEWER	Maximum Channel most significant error	18	RO	INT32
AB08	43784	VIEWER	Maximum Channel dynamic threshold on UP channel	12	RO	INT32
AB0A	43786	VIEWER	Maximum Channel dynamic threshold on DOWN channel	12	RO	INT32
AB0C	43788	VIEWER	Maximum Channel #Errors of Last 16	18	RO	INT32
CH Real Min						
AE00	44544	VIEWER	Minimum Channel Velocity	20	RO	(IEEE 32 bit)
AE02	44546	VIEWER	Minimum Channel Sound Speed	20	RO	(IEEE 32 bit)
AE04	44548	VIEWER	Minimum Channel Transit Time Up	19	RO	(IEEE 32 bit)
AE06	44550	VIEWER	Minimum Channel Transit Time Dn	19	RO	(IEEE 32 bit)
AE08	44552	VIEWER	Minimum Channel DeltaT	19	RO	(IEEE 32 bit)
AE0A	44554	VIEWER	Minimum Channel Time in buffer on DOWN channel	19	RO	(IEEE 32 bit)
AE0C	44556	VIEWER	Minimum Channel Up Signal Quality	18	RO	(IEEE 32 bit)
AE0E	44558	VIEWER	Minimum Channel Dn Signal Quality	18	RO	(IEEE 32 bit)
AE10	44560	VIEWER	Minimum Channel Up Amp Disc	18	RO	(IEEE 32 bit)
AE12	44562	VIEWER	Minimum Channel Dn Amp Disc	18	RO	(IEEE 32 bit)
AE14	44564	VIEWER	Minimum Channel Signal Gain Up	3	RO	(IEEE 32 bit)
AE16	44566	VIEWER	Minimum Channel Signal Gain Down	3	RO	(IEEE 32 bit)

Table 10: XMIT Modbus Map (cont.)

Register (in Hex)	Register (in Decimal)	Access Level	Variable	Unit Group	Read Only/ Read Write	Format
AE18	44568	VIEWER	Minimum Channel_SNR on UP channel	18	RO	(IEEE 32 bit)
AE1A	44570	VIEWER	Minimum Channel_SNR on DOWN channel	18	RO	(IEEE 32 bit)
AE1C	44572	VIEWER	Minimum Channel Time in buffer on UP channel	19	RO	(IEEE 32 bit)
CH Integer Min						
AF00	44800	VIEWER	Minimum Channel status bit map	18	RO	INT32
AF02	44802	VIEWER	Minimum Channel Up +- Peak	18	RO	INT32
AF04	44804	VIEWER	Minimum Channel Dn +- Peak	18	RO	INT32
AF06	44806	VIEWER	Minimum Channel most significant error	18	RO	INT32
AF08	44808	VIEWER	Minimum Channel dynamic threshold on UP channel	12	RO	INT32
AF0A	44810	VIEWER	Minimum Channel dynamic threshold on DOWN channel	12	RO	INT32
AF0C	44812	VIEWER	Minimum Channel #Errors of Last 16	18	RO	INT32
Ultrasonic Files						
A000	40960	VIEWER	Channel 1 Raw Up	18	RO	signed short
A001	40961	VIEWER	Channel 1 Raw Down	18	RO	signed short
A002	40962	VIEWER	Channel 1 Correlate Up	18	RO	signed short
A003	40963	VIEWER	Channel 1 Correlate Down	18	RO	signed short
A004	40964	VIEWER	Channel 1 CrossCorrelation	18	RO	signed short
A010	40976	VIEWER	Channel 2 Raw Up	18	RO	signed short
A011	40977	VIEWER	Channel 2 Raw Down	18	RO	signed short
A012	40978	VIEWER	Channel 2 Correlate Up	18	RO	signed short
A013	40979	VIEWER	Channel 2 Correlate Down	18	RO	signed short
A014	40980	VIEWER	Channel 2 CrossCorrelation	18	RO	signed short

Table 10: XMIT Modbus Map (cont.)

C.4 Modbus unit codes

Many of the items in the Modbus map have a unit of measure. The codes for these unit types are listed in Table 11 below. These are the standard Foundation Fieldbus unit codes.

Value	Unit Codes	Symbol	Description
Temperature			
	1000	K	Kelvin
	1001	C	degree Celsius
	1002	F	degree Fahrenheit
	1003	R	degree Rankine
Dimension			
	1010	m	meter (default)
	1013	mm	millimeter
	1018	ft	feet
	1019	in	inch
Volume			
	1034	m3	cubic meter
	1038	L	liter
	1042	in3	cubic inch
	1043	ft3	cubic feet
	1048	gal	US gallon
	1051	BBL	barrel
	1667	MGAL	Mega Gallons
	1663	MFT3	Mega Cubic Feet
	1664	MBBL	Mega Barrels
	1645	ML	Mega Liters
	1668	Mm3	Mega Cubic Meters
Mass/Weight			
	1088	k	kilogram
	1092	t	metric ton
	1094	LB	pound (mass)
	1095	SHTN	short ton
Density			
	1097	kg/m3	Kilograms per cubic meter (default)
	1107	LB/ft3	pounds per cubic foot

Table 11: Unit Codes for XMT900

Value	Unit Codes	Symbol	Description
Mass Flow			
	1322	KG/S	kilogram per second (default)
	1323	KG/M	kilogram per minute
	1324	KG/H	kilogram per hour
	1325	KG/D	kilogram per day
	1326	TNE/S	metric ton per second
	1327	TNE/M	metric ton per minute
	1328	TNE/H	metric ton per hour
	1329	TNE/D	metric ton per day
	1330	LB/S	pound per second
	1331	LB/M	pound per minute
	1332	LB/H	pound per hour
	1333	LB/D	pound per day
	1334	SHTN/S	short ton per second
	1335	SHTN/M	short ton per minute
	1336	SHTN/H	short ton per hour
	1337	SHTN/D	short ton per day
	1644	KLB/S	Kilo pound per second
	1643	KLB/M	Kilo pound per minute
	1642	KLB/H	Kilo pound per hour
	1641	KLB/D	Kilo pound per day
Volume Flow (also called Actual Volumetric Flow)			
	1347	m3/S	cubic meter per second (default)
	1348	m3/M	cubic meter per minute
	1349	m3/H	cubic meter per hour
	1350	m3/D	cubic meter per day
	1351	L/S	liter per second
	1352	L/M	liter per minute
	1353	L/H	liter per hour
	1354	L/D	liter per day
	1356	ft3/S	cubic feet per second
	1357	ft3/M	cubic feet per minute
	1358	ft3/H	cubic feet per hour
	1359	ft3/D	cubic feet per day

Table II: Unit Codes for XMT900 (cont.)

Value	Unit Codes	Symbol	Description
Volume Flow (also called Actual Volumetric Flow) (cont.)			
	1362	GAL/S	US gallon per second
	1363	GAL/M	US gallon per minute
	1364	GAL/H	US gallon per hour
	1365	GAL/D	US gallon per day
	1371	BBL/S	barrel per second
	1372	BBL/M	barrel per minute
	1373	BBL/H	barrel per hour
	1374	BBL/D	barrel per day
	1454	KGAL/M	kilo US gallon per minute
	1458	KGAL/H	kilo US gallon per hour
	1462	KGAL/D	kilo US gallon per day
	1485	KBBL/M	kilobarrel per minute
	1489	KBBL/H	kilobarrel per hour
	1493	KBBL/D	kilobarrel per day
Standard Volume Flow			
	1537	SL/S	Standard Liters per Second (default)
	1538	SL/M	Standard Liters per Minute
	1539	SL/H	Standard Liters per Hour
	1540	SML/D	Standard Mega Liters per Day
	1527	Sm ³ /S	Standard Cubic Meter per Second
	1528	Sm ³ /M	Standard Cubic Meter per Minute
	1529	Sm ³ /H	Standard Cubic Meter per Hour
	1530	Sm ³ /D	Standard Cubic Meter per Day
	1361	SCFH	standard cubic feet per hour
	1360	SCFM	standard cubic feet per minute
Velocity Units			
	1061	m/s	Meters per sec (default)
	1067	ft/s	Feet per sec
Time Units			
	1054	s	second
	1056	ms	Millisecond
	1057	us	Microsecond
	1059	h	Hour

Table II: Unit Codes for XMT900 (cont.)

Value	Unit Codes	Symbol	Description
Frequency Units			
	1077	Hz	Hertz
	1080	MHz	Mega Hertz
	1081	kHz	Kilo Hertz
Current			
	1209	amp	Ampere
	1211	ma	Milliampere

Table 11: Unit Codes for XMT900 (cont.)

C.5 Modbus protocol

In general, the PanaFlow HT flowmeter follows the standard Modbus communications protocol defined by the reference MODBUS APPLICATION PROTOCOL SPECIFICATION V1.1b.

This specification is available at www.modbus.org on the Internet. With this reference as a guide, an operator could use any Modbus master to communicate with the flowmeter.

Listed below are two limits of this implementation:

- The PanaFlow HT supports only four of the standard function codes. These are Read Holding Registers (0x03), Read Input Registers (0x04), Write Multiple Registers (0x10), and Read File Record (0x14).

and

- The flowmeter needs a 15 msec gap between Modbus requests. The prime objective of the flowmeter is to measure flow and drive the SIL output, so the Modbus server has a low priority.

[no content intended for this page]

Appendix D. HART menu maps

D.1 HART connection

D.1.1 Wiring to the HART circuit

When connecting a HART communicator to the wiring terminals on the PanaFlow HT electronics terminal board, the circuit must be terminated in an appropriate resistive load, as shown in Figure 34 below. The HART communicator is connected in parallel with that load.

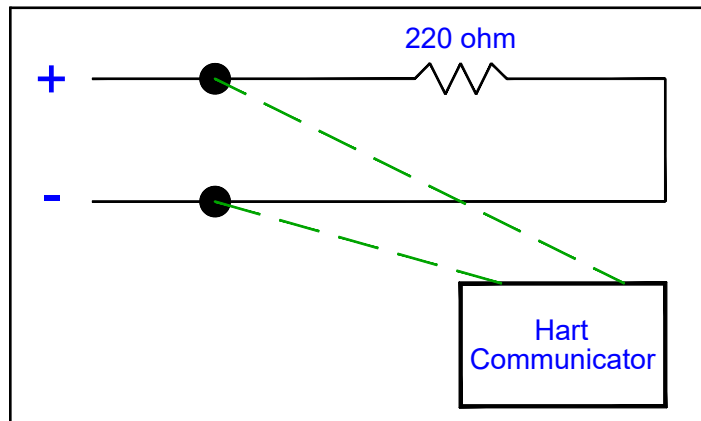


Figure 34: Wiring Diagram for HART Communication

D.1.2 Write mode switch

The PanaFlow HT HART circuit includes a slide switch which can be used to disable write access to the instrument via HART. This white slide switch (pictured below) is designed to Lock Out HART configuration access for those customers who require this extra level of security. With the Write Mode switch pushed toward the Display board (as shown above), the HART circuit is in write access mode.



Figure 35: HART Circuit Write Mode Switch

D.1.2 Write mode switch (cont.)

Note: The following sections of this Appendix provide a map to programming functions via HART communication. To make programming changes through HART, the HART circuit must be set to “write” mode. If your HART device cannot make program changes, inspect the switch to be sure your HART circuit is in “write” mode.

D.1.3 Use force high with HART

The Authorized User may select Force High or Force Low for the Dangerous Detected state, the mA level that the SIL Output will go to in case of an error detection. If the HART signal is going to be used by the system for frequent communication, we recommend selecting Force High. The Force Low level, 3.6 mA, is marginally capable of carrying HART signals. By selecting Force High, 21.0 mA, the Operator can be confident that in case of a fault condition HART communication will be available to diagnose the cause of the fault

D.2 Root menu

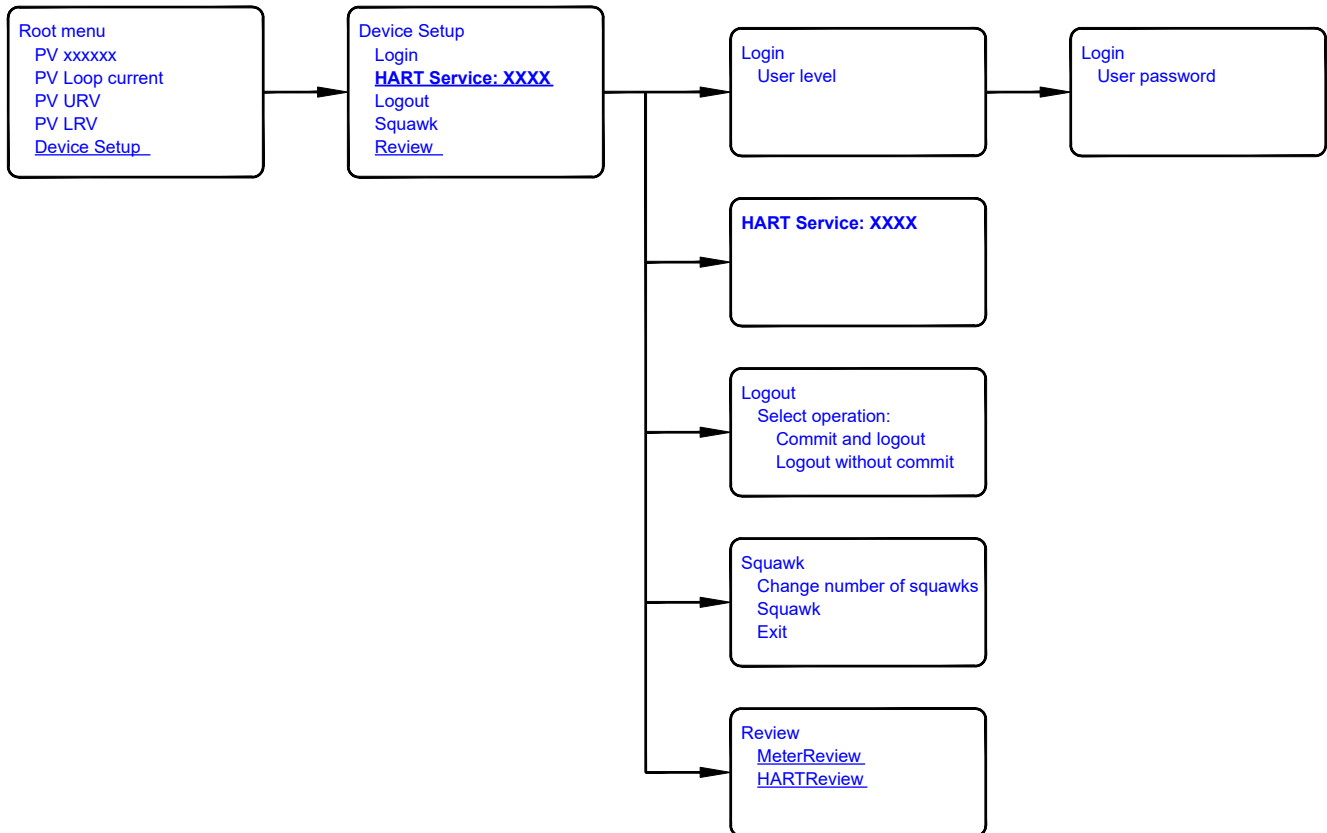


Figure 36: Root Menu

D.3 HART service map for general users

If users log in the system with a General User password, they can edit the variables below in the HART Service menu.

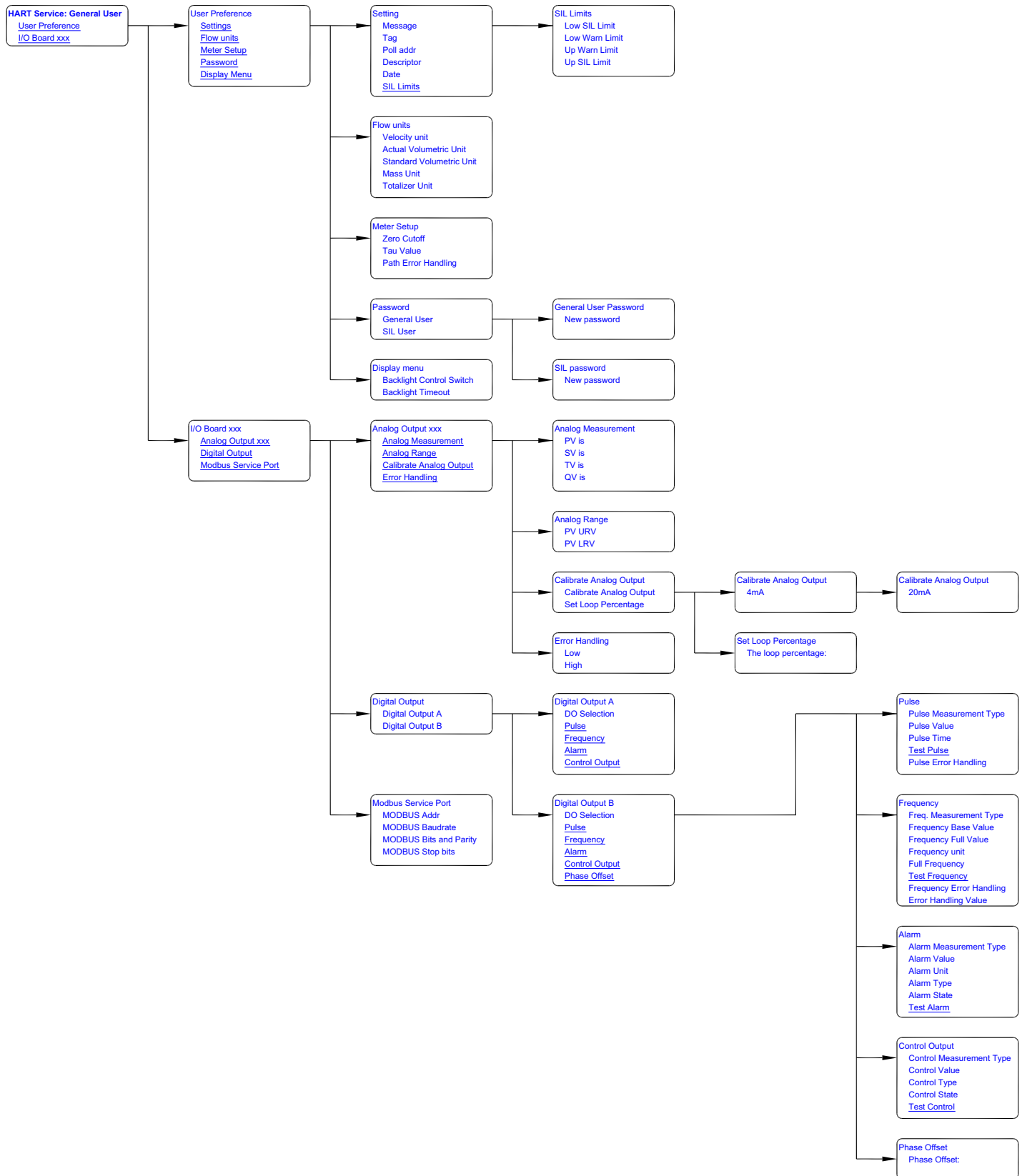


Figure 37: HART Service Menu for General User

D.4 HART service menu for SIL users

If users log in the system with a SIL User/ Service User / Factory User password, they can edit the variables in the HART Service menu as shown below.

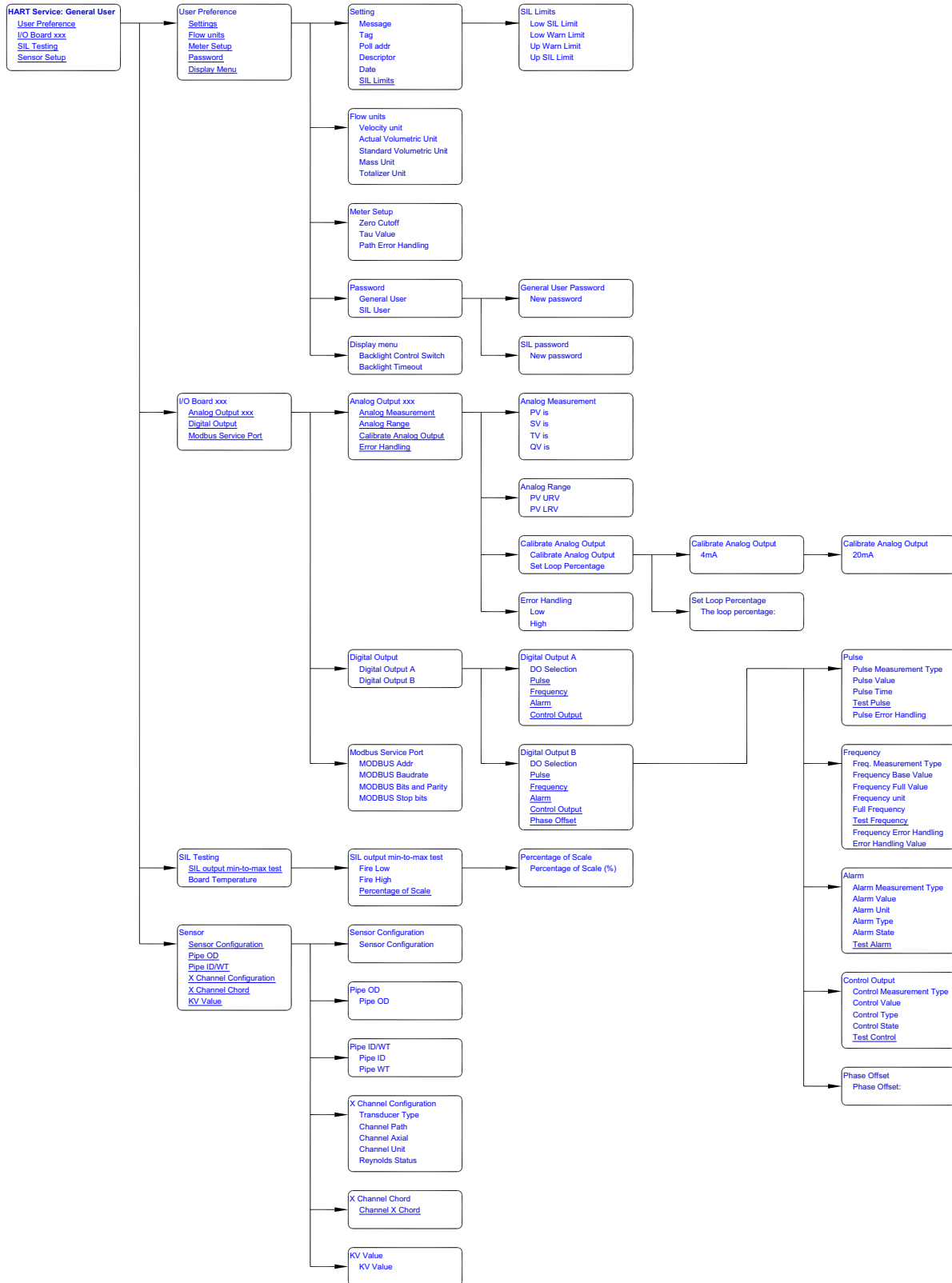


Figure 38: HART Service Menu for SIL User and Higher Levels

D.5 Review menu

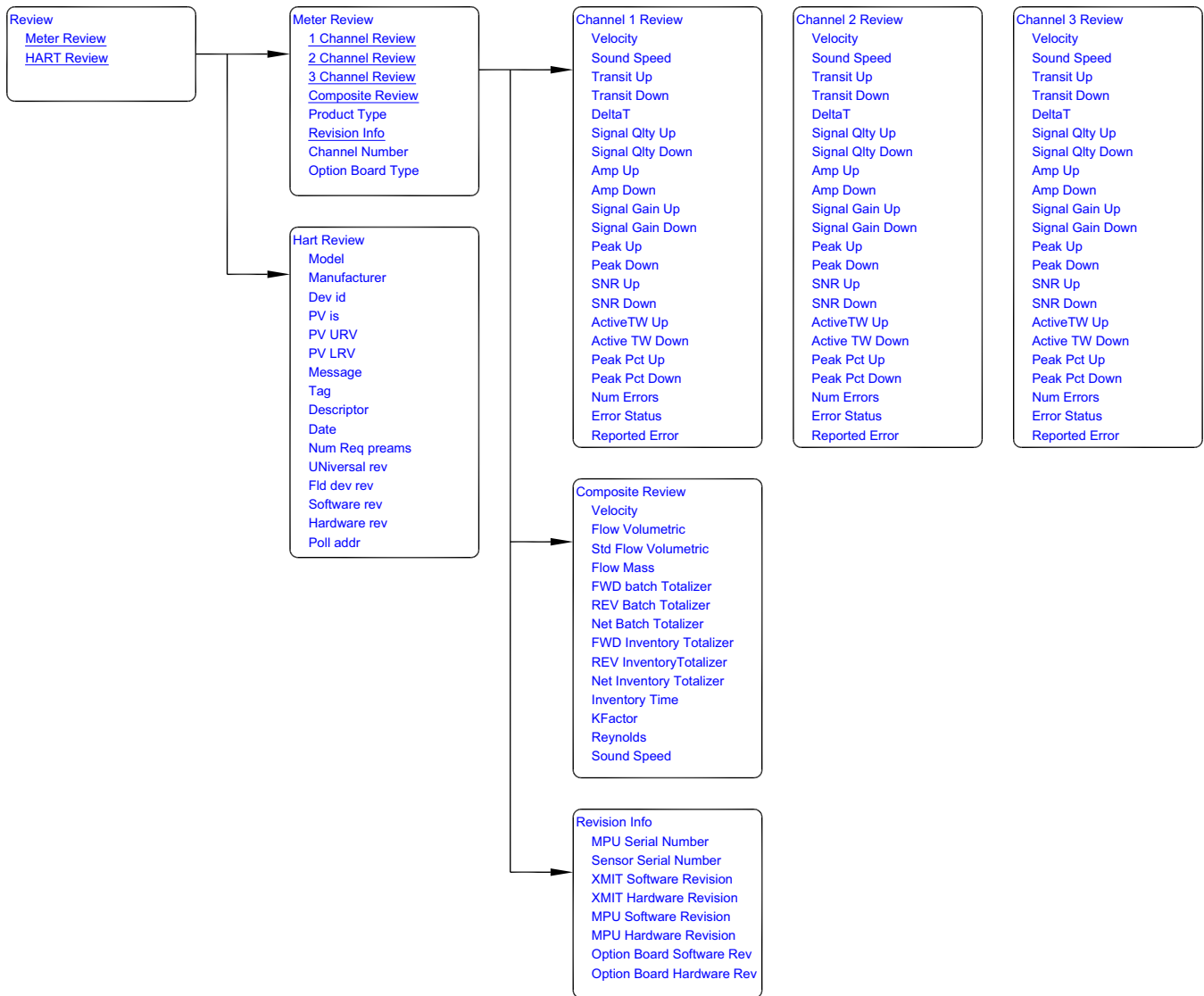


Figure 39: Review Menu

[no content intended for this page]

Appendix E. Special applications

E.1 Pig detection

When a pig passes through the pipeline, it will block the ultrasonic signals for a brief time. In previous products, this might have resulted in a slight blip on the strip chart recorder or been completely missed, but the PanaFlow HT makes flow measurements so fast that it will identify the pig in the line and signal a flow error. The expected result is an error on the LCD, and the SIL Output will go to Fire Low or Fire High, depending on what the Dangerous Detected state is set to. Once in that state, the flowmeter is designed to remain in that state until an Authorized User intervenes.

There is a simple method for clearing the error. The Authorized User goes into the Program Menu by entering a valid SIL User password, then the Authorized User exits again without making any changes. This ensures the flowmeter that an Authorized User is intervening, because the password checks out. This will clear the error.

If the Safety Engineer on site wishes to clear this type of error automatically, the DCS may be set up to do so. It is the responsibility of the Safety Engineer at the customer site to ensure that this method is properly protected by a password or other means in the DCS to avoid a risk of clearing errors unwisely.

What follows is the method for setting the DCS to clear a Dangerous Detected state in the flowmeter. The DCS would issue the following commands over Modbus.

Note: The SIL User password indicated in step 2 is unique to every flowmeter, so please insert your unique code where the XXXX is stated.

1. Write "2" to SysReqLevel reg. 0x540 to program "SIL USER"
2. Write SIL User password "XXXX" to SysReq_Password reg. 0x542
3. Write "1" to SysReq_Command reg. 0x544 to execute "logging in"
4. Write "3" to SysReq_Command reg. 0x544; UPMU resets, takes about 1 sec to process reset.

Note: The DCS will record a Fire Low or Fire High, followed by a return to normal flow measurement after a few seconds. This may serve to indicate to the Operator when a pig passed through a particular measurement point.

If there are any questions, please contact Panametrics Service.

E.2 Path error handling

One program parameter that is in the menu map but not used by the PanaFlow HT is 2-path Error Handling. However, an explanation of this parameter is included here for future reference.

In this context, a “path” is a measurement channel in the flowcell. The PanaFlow HT electronics is compatible with five possible path configurations, two of which are released for purchase. The five configurations are:

1. Single mid-radius path
2. Single diameter path
3. Two mid-radius paths
4. Two crossed-diameter paths
5. Three paths - 1 diameter and 2 mid-radius

PanaFlow HT offers options 2 (PanaFlow Z1H) and 3 (PanaFlow Z2H). One can also purchase the PanaFlow R2H, which consists of two sets of redundant electronics, each set up as option 2 above.

The 2-path Error Handling technique only applies to a system with two or more paths. For multi-path systems, the technique only applies to symmetrical pairs of paths, or “sister” paths. For applicability, see the table below:

Flowcell	Symmetrical Paths
3. Two mid-radius paths	Two mid-radius paths
4. Two crossed-diameter paths	Two diameter paths
5. Three paths - 1 diameter and 2 mid-radius	Two mid-radius paths

With the physical layout in mind, the error handling technique should be fairly simple to understand. The theory is that for homogeneous, well-developed flow conditions, the symmetrical paths should be measuring the same flow rate. Therefore, if one of those paths goes into error, we can assume the measurement would have been the same as the other path and substitute that value.

Therefore, with 2-path error handling turned ON, the following actions result from the various error detection scenarios.

2-path system (with 2-path error handling ON)

Error Detection Scenario	Action
Path 1 error	Substitute path 2 measurement, keep measuring
Path 2 error	Substitute path 1 measurement, keep measuring
Path 1 and Path 2 in error	Multichannel Error, stop measuring

E.2 Path error handling (cont.)

Note: Path 1 and Path 2 are the mid-radius paths. Path 3 is the diameter path. There is no symmetrical path for Path 3.

3-path system (with 2-path error handling ON)

Error Detection Scenario	Action
Path 1 error	Substitute path 2 measurement, keep measuring
Path 2 error	Substitute path 1 measurement, keep measuring
Path 3 error	Single Channel Error, stop measuring
Path 1 and Path 2 in error	Multichannel Error, stop measuring
Path 2 and Path 3 in error	Multichannel Error, stop measuring
Path 1 and Path 3 in error	Multichannel Error, stop measuring
Path 1, Path 2, and Path 3 in error	Multichannel Error, stop measuring

With 2-path Error Handling set to OFF, there are only two error conditions. If any one path is in error, the reaction is Single Channel Error, stop measuring. If more than one path is in error, the reaction is Multichannel Error, stop measuring.

[no content intended for this page]

Appendix F. Data records

F.1 Service record

Whenever any service procedure is performed on the PanaFlow HT flow transmitter, the details of the service should be recorded in this appendix. An accurate service history of the meter can prove very helpful in troubleshooting any future problems.

Record complete and detailed service data for the PanaFlow HT in Table 12 below. Make additional copies of the table as needed.

Date	Description of Service	Performed By

Table 12: Service Record

Date	Description of Service	Performed By

Table 12: Service Record (cont.)

F.2 Initial settings

The values for the initial measurement settings immediately after initial installation of the meter and verification of proper operation should be entered in Table 13 below.

Parameter	Initial Value
Velocity	
Volumetric	
Mass Flow	
Forward Batch Totals	
Reverse Batch Totals	
Totalizer Time	
Sound Speed	
Current Correction Factor	
Current Reynolds Number	
Current Operating Temperature	
Standard Volumetric	
Net Batch Totals	
Inventory Forward	
Inventory Reverse	
Inventory Net	
Inventory Time	
Channel 1 Velocity	
Channel 1 Sound Speed	
Channel 1 Transit Time Up	
Channel 1 Transit Time Down	
Channel 1 Delta T	
Channel 1 Up Signal Quality	
Channel 1 Down Signal Quality	
Channel 1 Up Amp Disc	
Channel 1 Down Amp Disc	
Channel 1 SNR on Up	

Table 13: Initial Settings

Parameter	Initial Value
Channel 1 SNR on Down	
Channel 1 Time in Buffer on Up	
Channel 1 Time in Buffer on Down	
Channel 1 Signal Gain Up	
Channel 1 Signal Gain Down	
Channel 1 Up Peak	
Channel 1 Down Peak	
Channel 1 Dynamic Threshold Up	
Channel 1 Dynamic Threshold Down	
Channel 2 Velocity	
Channel 2 Sound Speed	
Channel 2 Transit Time Up	
Channel 2 Transit Time Down	
Channel 2 Delta T	
Channel 2 Up Signal Quality	
Channel 2 Down Signal Quality	
Channel 2 Up Amp Disc	
Channel 2 Down Amp Disc	
Channel 2 SNR on Up	
Channel 2 SNR on Down	
Channel 2 Time in Buffer on Up	
Channel 2 Time in Buffer on Down	
Channel 2 Signal Gain Up	
Channel 2 Signal Gain Down	
Channel 2 Up Peak	
Channel 2 Down Peak	
Channel 2 Dynamic Threshold Up	
Channel 2 Dynamic Threshold Down	

Table 13: Initial Settings (cont.)

F.3 Diagnostic parameters

The values for the diagnostic parameters immediately after initial installation of the meter and verification of proper operation should be entered in Table 14 below. These initial values can then be compared to current values to help diagnose any future malfunction of the system.

Parameter	Initial	Current	Parameter	Initial	Current
Ch1 Velocity			Ch2 Velocity		
Ch1 Soundspeed			Ch2 Soundspeed		
Ch1 Transit Time Dn			Ch2 Transit Time Dn		
Ch1 Transit Time Up			Ch2 Transit Time Up		
Ch1 Delta T			Ch2 Delta T		
Ch1 Up Signal Quality			Ch2 Up Signal Quality		
Ch1 Dn Signal Quality			Ch2 Dn Signal Quality		
Ch1 Up Amp Disc			Ch2 Up Amp Disc		
Ch1 Dn Amp Disc			Ch2 Dn Amp Disc		
Ch1 SNR Up			Ch2 SNR Up		
Ch1 SNR Dn			Ch2 SNR Dn		
Ch1 Active TWup			Ch2 Active TWup		
Ch1 Active TWdn			Ch2 Active TWdn		
Ch1 Gainup			Ch2 Gainup		
Ch1 Gaindn			Ch2 Gaindn		
Ch1 Error Status			Ch2 Error Status		
Ch1 Report Error			Ch2 Report Error		
Ch1 Peak Up			Ch2 Peak Up		
Ch1 Peak Dn			Ch2 Peak Dn		
Ch1 Peak% Up			Ch2 Peak% Up		
Ch1 Peak% Dn			Ch2 Peak% Dn		
Ch1 Error			Ch2 Error		

Table 14: Diagnostic Parameters

[no content intended for this page]

Appendix G. CE Mark compliance

G.1 Introduction

For CE Mark compliance, the PanaFlow HT flowmeter must be wired in accordance with the instructions in this appendix.

IMPORTANT:

CE Mark compliance is required for all units intended for use in EU countries.

G.2 Wiring

The PanaFlow HT must be wired with the recommended cable, and all connections must be properly shielded and grounded. Refer to Table 15 below for the specific requirements.

Connection	Cable Type	Ground Termination
Transducer	Armored RG62 a/U	Grounded using a cable gland.
Input/Output	Armored 22 AWG shielded (e.g. Baystate #78-1197) with armored material added to outside of jacket	Grounded using a cable gland.
Power	Armored 14 AWG 3 conductor	Grounded using a cable gland.

Table 15: Wiring Requirements

Note: If the Panaflow HT is wired as described in this appendix, the unit will comply with the EMC Directive 2004/108/EC.

[no content intended for this page]

A

Access Levels.....	39
Accuracy.....	85
Active Temperature Compensation.....	3
Alarm, Setting.....	67
Alarms.....	17
Wiring.....	17
Alarms Option Card	
Fail-Safe Operation.....	17
Analog Measurements.....	57
Analog Measurements, Setting.....	53
Analog Output Menu.....	51, 52, 56, 57
Analog Outputs	
Wiring.....	13
Analog Outputs (Slot 0)	
Connecting.....	13
Arrow Keys.....	27

B

Backlight, Setting.....	50
Backlight, Timeout.....	51
Base Value, Setting.....	54, 58
Baud Rate.....	72
Bundle Waveguide Technology™ System.....	86

C

Cable	
Transducers.....	9
Cable Lengths.....	9
Calibrating Analog Output.....	55
Calibration Port	
Wiring.....	20
Calibration Value, Selecting.....	58, 59
CE Mark Compliance.....	145
Channels.....	87
Communication Error String.....	78
Connecting	
See Part Name	
Control Output	
Wiring.....	18
Control Output, Setting.....	69
Corrosion, Transducers.....	83

D

Data Logging.....	88
Decimal Places	
Programming for Totalizer.....	33
Density	
Changing Flow Units.....	46
Diagnostic Parameters	
Initial Values.....	141, 143
Table of Values.....	141, 143
Diagnostics.....	81
Digital Outputs	
Wiring.....	14
Digital Outputs, Programming.....	60
Display Option.....	50
Display Programming.....	29
Document Number.....	i
Down Arrow Key.....	27

E

Electrical Connections.....	11
Electronics.....	10
Electronics Classifications.....	87
Electronics Console	
Mounting.....	10
Electronics Enclosure	
Location.....	9
Electronics Enclosures.....	87
Electronics Mounting.....	87
Enter Key.....	27
Environmental Compliance.....	viii
Error Display.....	77
Error Handling, Setting.....	55, 59
Error Header.....	77
Error String	
SIL.....	80
Error String, Communication.....	78
Error String, Flow.....	78
Escape Key.....	27

F

Flow Error String.....	78
Flow Measurement.....	85
Flowcell Problems.....	81

Fluid	81
Pipe	82
Fluid	
Physical Requirements	81
Problems	81
Soundspeed	81
Fluid Problems	81
Fluid Types	85
Frequency Output	
Wiring	16
Frequency, Setting	63
Full Value, Setting	54, 58

G

Global	
Menu	37
Submenus	37
Grounding	11

H

HART Menu Maps	129
----------------------	-----

I

Identification	
Meter Body	7
XMT Transmitter	6
Identification Labels	6
Information Paragraphs	vii
Input Voltage	21
Input/Output Menu	51
Inputs/Outputs	87

K

Keypad	87
Keypad Lockout	37
Keypad Program, Exiting if Unused	28

L

Language Change	41
Languages	87
Leaks, Transducers	83
Left Arrow Key	27

Line Power	
Wiring	21
Location	
Electronics Enclosure	9
Locking Keypad	37
LVD Statement	9

M

Magnetic Keypad, Using	27
Main Menu	
Entering	36
Main Menu Map	36
Mass, Changing Flow Units	44
Measurement Type	
Programming	29
Menu Map	25
Meter Body	
Identification	7
Materials	86
Meter Setup Option	47
Meter Sizes	85
Meter Tag	41
Min/Max Output, Testing	75
Modbus	
Wiring	19
Modbus Stop Bits	74
Modbus/Service Port Address	73
Modbus/Service Port, Setting Up	72
Mounting	10
Electronics	10

O

On Board Temperature, Setting	76
Operating Temperature	88
Output A Option Board, Programming	51
Output Analog Switch, Testing	76
Output B Option Card	56

P

PanaFlow HT	
Electrical Connections	11
Electronics Package	10

Identification	6
Magnetic Keypad	27
Overview	1
Transport	7
Unpacking	6
Password	49
Path Error Handling	48
Pig Detection	135
Pipe	
Measurements	82
Problems	82
Pipe Problems	82
Power	
Connecting	21
Terminal Block	21
Power Consumption	88
Power Supplies	88
Pressure Range	86
Problems, Transducers	83
Program Menu	38
Program Review menu	38
Programming	
Display Parameters	29
Entering	39
Measurement Type	29
Pulse Output, Setting	62

R

Range	85
Rangeability	85
Remote Mount Cable	
Wiring	22
Repeatability	85
Right Arrow Key	27

S

Safety	
Auxiliary Equipment	vii
General Issues	vii
Personal Equipment	viii
Safety Codes	5
Service Record	139
Settings	41

SIL Application	3
SIL Certification	85
SIL Error String	80
SIL Limits	42
SIL Testing	74
Slot 0	
See Analog Outputs (Slot 0)	
Soundspeed	
Fluid	81
Special Applications	135
Specifications	85
Starting or Stopping	35

T

Tau Value	48
Temperature Ranges	
Transducer	86
Terminal Block	
Analog Outputs - I/O	13
Power - TBI	21
Theory of Operation	2
Totalizer	
Changing Measurement Units	45
Resetting	35
Totalizer Measurement	35
Totalizer Net	70
Totalizer Output	
Wiring	15
Totalizer Programming	
Decimal Places	33
Transducer Cables	9, 86
Transducer Classifications	86
Transducer Problems	83
Transducer System	86
Transducers	
Cables	9
Corrosion	83
Internal Damage	83
Leaks	83
Location	8
Physical Damage	83
Placement	82
Problems	83

Replacement.....	83
Transit-Time Flow Measurement.....	2
Transporting.....	7

U

UART Bits.....	73
Unlocking Keypad.....	37
Unpacking.....	6
Up Arrow Key.....	27
User Levels.....	39
User Preferences.....	40

V

Velocity, Setting Flow Units.....	43
Voltage, Input.....	21

W

Watchdog Test.....	76
WEEE Directive.....	viii
Wiring.....	17
Analog Outputs.....	13
Calibration Port.....	20

CE Mark Compliance.....	145
Control Output.....	18
Digital Outputs.....	14
Frequency Output.....	16
Line Power.....	21
Modbus/Service Port.....	19
Option Card.....	See Card Name
Preparation.....	12
Terminal Block.....	See Block Name
Totalizer (Pulse) Output.....	15
Transducers (Remote Mount Cable).....	22
Wiring Connection.....	88
Wiring Diagram	
PanaFlow HT	
Wiring Diagram.....	11

X

XMT900 Transmitter	
Identification.....	6

Z

Zero Cutoff.....	47
------------------	----

Warranty

Each instrument manufactured by Panametrics is warranted to be free from defects in material and workmanship. Liability under this warranty is limited to restoring the instrument to normal operation or replacing the instrument, at the sole discretion of Panametrics. Fuses and batteries are specifically excluded from any liability. This warranty is effective from the date of delivery to the original purchaser. If Panametrics determines that the equipment was defective, the warranty period is:

- one year from delivery for electronic or mechanical failures
- one year from delivery for sensor shelf life

If Panametrics determines that the equipment was damaged by misuse, improper installation, the use of unauthorized replacement parts, or operating conditions outside the guidelines specified by Panametrics, the repairs are not covered under this warranty.

The warranties set forth herein are exclusive and are in lieu of all other warranties whether statutory, express or implied (including warranties or merchantability and fitness for a particular purpose, and warranties arising from course of dealing or usage or trade).

Return Policy

If a Panametrics instrument malfunctions within the warranty period, the following procedure must be completed:

1. Notify Panametrics, giving full details of the problem, and provide the model number and serial number of the instrument. If the nature of the problem indicates the need for factory service, Panametrics will issue a RETURN AUTHORIZATION NUMBER (RAN), and shipping instructions for the return of the instrument to a service center will be provided.
2. If Panametrics instructs you to send your instrument to a service center, it must be shipped prepaid to the authorized repair station indicated in the shipping instructions.
3. Upon receipt, Panametrics will evaluate the instrument to determine the cause of the malfunction.

Then, one of the following courses of action will then be taken:

- If the damage is covered under the terms of the warranty, the instrument will be repaired at no cost to the owner and returned.
- If Panametrics determines that the damage is not covered under the terms of the warranty, or if the warranty has expired, an estimate for the cost of the repairs at standard rates will be provided. Upon receipt of the owner's approval to proceed, the instrument will be repaired and returned.

Customer support centers

Americas

U.S.A.

Panametrics

1100 Technology Park Drive

Billerica, MA 01821

U.S.A.

Tel: +1 800 833 9438 (toll-free)

Tel: +1 978 437 1000

E-mail: mstechsupport@bakerhughes.com

Europe

Ireland

Panametrics

Shannon Free Zone East

Shannon, County Clare

Ireland

Tel: +353 61 61470200

E-mail: mstechsupport@bakerhughes.com

Panametrics, a Baker Hughes business, provides solutions in the toughest applications and environments for moisture, oxygen, liquid and gas flow measurement.

Experts in flare management, Panametrics technology also reduces flare emissions and optimizes performance.

With a reach that extends across the globe, Panametrics' critical measurement solutions and flare emissions management are enabling customers to drive efficiency and achieve carbon reduction targets across critical industries including: Oil & Gas; Energy; Healthcare; Water and Wastewater; Chemical Processing; Food & Beverage and many others.

Join the conversation and follow us on LinkedIn
[linkedin.com/company/panametricscompany](https://www.linkedin.com/company/panametricscompany)

Copyright 2021 Baker Hughes Company. All rights reserved.

910-294U Rev. A
BHCS39026

(07/2021)

Baker Hughes 

[panametrics.com](https://www.panametrics.com)