

# PV624

## Hybrid Pressure Station Instruction Manual



# Contents

<b>1.</b>	<b>Overview</b>	<b>1</b>
1.1	Introduction	1
1.2	Other Module Options	1
1.3	Summary of Functions	2
1.4	Quick Reference Data	3
1.5	Equipment in the Box	3
1.6	Safety	4
1.6.1	General Warnings	4
1.6.2	Pressure Warnings	4
1.6.3	Electrical Warnings	4
1.6.4	Software Configuration and Security	5
1.7	Over-voltage Categories	5
1.8	Product Label	6
<b>2.</b>	<b>Instrument Parts</b>	<b>7</b>
2.1	Introduction	7
2.2	PV624 Parts	7
2.2.1	Pressure Release Knob and Barometric Port	8
2.2.2	Test Port and Adapter	8
2.2.3	Pump (Pressure/Vacuum)	8
2.2.4	Bluetooth Button	9
2.2.5	Power Button	9
2.2.6	Battery	9
2.2.7	Bluetooth LED	9
2.2.8	Status LED	10
2.2.9	Battery Level Indicator	10
<b>3.</b>	<b>Pneumatic Pressure Operation</b>	<b>11</b>
3.1	Introduction	11
3.2	Release the Pressure	11
3.3	Attach/Remove the Device Under Test	11
3.3.1	Use of Blanking Plug	12
3.3.2	Attach an Instrument Dirt (and Moisture) Trap to the Test Port	12
3.3.3	Attach Device Under Test	12
3.3.4	Remove Device Under Test	13
3.4	Assembly Instructions	14
3.5	Pressure or Vacuum Operation	15
<b>4.</b>	<b>Pressure Calibrator Operation (DPI620G)</b>	<b>16</b>
4.1	Introduction	16
4.2	Parts and Assembly	16
4.2.1	DPI620G Calibrator Parts	16
4.2.2	PM620/PM620T Module Parts	17
4.3	Basic Channel Settings	17
4.3.1	Overview	17
4.3.2	DPI620G Calibrator: Set the Pressure Units	17
4.3.3	DPI620G Calibrator: Process	18
4.3.4	DPI620G Calibrator: Step Mode (Nudge)	19

4.3.5	DPI620G Calibrator: Step Mode (Percent Step)	20
4.3.6	DPI620G Calibrator: Step Mode (Defined Step)	21
4.3.7	DPI620G Calibrator: Step Mode (Point Step)	22
4.3.8	DPI620G Calibrator: Set the PM620/PM620T Module to Zero	23
4.3.9	DPI620G Calibrator: Set the Pressure Type	24
4.3.10	DPI620G Calibrator: Resolution	24
4.4	Utility (Channel Settings)	25
4.4.1	DPI620G Calibrator: Set the Pressure Function	25
4.4.2	DPI620G Calibrator: Set the Pressure Units	26
4.4.3	DPI620G Calibrator: Set Up a Leak Test	26
4.4.4	DPI620G Calibrator: Set Max/Min/Mean Test	28
4.4.5	Example Procedure: Relief Valve Test	29
4.4.6	DPI620G Calibrator: Set Up a Switch Test	30
4.4.6.1	Switch Test Procedure	30
4.5	Settings Menu	33
4.5.1	Overview of Settings Menu	33
4.5.2	DPI620G Calibrator: View the Base Battery Status	33
4.5.3	DPI620G Calibrator: View the Base Status and Barometer Status	34
4.5.4	DPI620G Calibrator: Connect PV624 via Bluetooth	35
4.5.5	DPI620G Calibrator: Adjust the Barometer Calibration Date and Interval	36
4.5.6	Example Procedure: Barometer Calibration	37
5.	Help Menu	40
5.1	Overview	40
6.	Maintenance Procedures	41
6.1	Introduction	41
6.2	Service and Repair	41
6.3	Visual Inspection	41
6.4	Clean the Unit	41
6.5	Leak Test	42
6.5.1	Preparation	42
6.5.2	Procedure	42
6.6	Replacement of Battery	43
6.7	Spares	43
6.8	Instrument Return	43
6.8.1	Returned Goods Procedure	43
6.8.2	Instrument Disposal	43
6.9	Firmware Upgrade	43
7.	Test Procedures	44
7.1	Overview	44
7.2	Downloaded Procedures	44
7.3	Calibration Wizard	44
8.	Error Messages	45
8.1	PV624 Error Codes	45

9.	Specification	47
9.1	PV624 Model	47
	9.1.1 Pressure Data (PV624)	48
9.2	PM620/PM620T Module	49
	9.2.1 Pressure Data (PM620/PM620T modules)	49
Appendix A. COMPLIANCE STATEMENTS		50
A.1	FCC (USA)	50
A.2	CANADA	51



# 1. Overview

This manual gives operation procedures and safety information for the PV624 pressure station. It is the responsibility of the user to make sure that only approved personnel can operate and do maintenance on the equipment.

**Note:** Before you operate the equipment, read and obey all warnings and cautions given in the Quick Start and Safety Manual for this instrument.

## 1.1 Introduction



PV624

The PV624 hybrid pressure station is a portable pressure calibrator with a manual pressure generation capability. A pump and automatic fine adjustment of pressure, operate together to control pressures at set values. The DPI620G instrument with its Graphical User Interface, together with 4-20mA supply and Voltage measurement, makes possible the calibration of pressure sensors / transmitters when it attaches to the PV624.

The PV624 uses the external pressure modules, PM620 or PM620T, together with an internal Barometer, to make accurate pressure measurements. The DPI620G has a smart and simple user interface. This makes it easy for a technician, service or maintenance engineer to operate it.

The PV624/DPI620G assembly when put together, is a practical and robust device that gives accurate measurements. It is battery-powered and uses a highly reliable pneumatic assembly for continuous and accurate performance for field calibration, even in harsh environmental conditions.

HART® communications, Foundation Fieldbus and Profibus communication protocols are available as options. Bluetooth is also available as an optional communication method.

This manual tells how to use the specific functions made available when a PV624 pressure station attaches to a DPI620G. Refer to the DPI620G instruction manual (K0541) for how to use its user interface and functions.

## 1.2 Other Module Options



Pressure calibrator

The PV624 is part of a group of hand-held modules give a wide range of calibrator functions.

**Pressure calibrator:** Attach the DPI620G calibrator and a PM620/PM620T module to PV624 to make a fully-integrated pressure calibrator instrument.

# Chapter 1. Overview



DPI620G

**Advanced modular calibrator, DPI620G (user manual - K0541):** This is a battery-powered instrument for electrical measure and source operations. It also supplies the power and user interface functions for all the add-on modules. You can use the touch-screen to show up to six different parameters.



PM620/PM620T

**Pressure modules, PM620/PM620T (this user manual):** These modules attach to PV624 to give the DPI620G calibrator the necessary pressure measurement functionality. They are fully interchangeable “plug and play” modules, with no initial set-up or user calibration.

## 1.3 Summary of Functions

This table gives a summary of the available functions with the PV624 pressure station.



PV624



Pressure calibrator

Function
<b>Pressure station</b>
Pressure from vacuum -0.9 barg to 20 barg (-12.328 to 300 psig)
Internal selector valve to change the pump operation from pressure generator to vacuum generator
Vent valve to control the release of pressure
"Quickfit" pressure adapters for the device under test
Pressure connection for a PM620/PM620T sensor (1 barg to 20 barg)
Internal automatic fine adjustments to give accurate control of pressure conditions
Latch mechanism to attach the DPI620G calibrator to make a fully integrated pressure calibrator instrument
<b>Pressure station + DPI620G calibrator + PM620/PM620T module</b>
Measure pressure/Leak test
Documenting software
4Sight2 integration
Barometer (Pseudo modes)
Bluetooth operation

## 1.4 Quick Reference Data

<b>PV624: Pneumatic pressure station</b>	
-0.9 barg to 20 barg (-12.328 to 300 psig)	
<b>Recommended pressure modules (PM620/PM620T)</b>	
PV624	0.7 barg to 20 barg (10.15 to 300 psig) full scale



**CAUTION** To prevent damage to the PM620/PM620T module, only use it within the specified pressure limit on the label.

## 1.5 Equipment in the Box

Make sure these items are with the PV624 when delivered:

1. DC Power Supply (IO610E-PSU)
2. Lithium-Ion Battery pack (IO624 -BATTERY)
3. G1/8 BSP Swivel Adapter (184-203)
4. 1/8 NPT Swivel Adapter (184-226)
5. Blanking Plug (111M7272-1)
6. (IDT) Instrument Dirt Trap (IO620-IDT621-NEW)
7. 2m USB Cable (IO610E-USB-CABLE)
8. PV624 Quick Start and Safety Manual (170M2459).

### 1.6 Safety

Before use of the instrument, make sure to read and understand all the related information. This includes: the applicable local safety procedures, this publication, and the instructions for the accessories/options/equipment that are to be used with it.

#### 1.6.1 General Warnings



**WARNING** It is dangerous to ignore the specified limits for the instrument or to use the instrument when it is not in its normal condition. Use the applicable protection and obey all safety precautions.

To avoid risk of an explosion, do not use the instrument in locations with explosive gas, vapour or dust.

#### 1.6.2 Pressure Warnings



**WARNING** Always wear applicable eye protection when pressurized parts are touched.

It is dangerous to attach an external source of pressure to a PV624. Use only the internal mechanisms to set and control the pressure in the pressure station.

Pressurized gases are dangerous. Safely release all the pressure before connection or disconnection of pressure equipment.

To prevent a dangerous release of pressure: make sure that all the related pipes, hoses and equipment have the correct pressure rating, and are safe to use and are correctly attached. Isolate and bleed the system before disconnection of a pressure connection.

**Note:** The pressure station does not allow internal overpressure (it will automatically vent). It does this to protect the internal pressure sensor and pump mechanism from damage.

**Note:** Maximum Working Pressure (MWP) is given by the label on the bottom of the PV624.

#### 1.6.3 Electrical Warnings

If the DPI620G calibrator is attached to the PV624, these warnings are applicable:



**RISK OF ELECTRIC SHOCK** To prevent electrical shocks or damage to the DPI620G calibrator, do not connect more than 30V between the terminals, or between the terminals and the ground (earth). Connections must be compatible with the terminal input/output parameters. See “Over-voltage Categories” on page 5. for more information.



**CAUTION** To prevent damage to the instrument, do not let dirt get into the pressure mechanism. Before attachment of equipment, make sure connections are clean.

To prevent damage to the instrument, hold the body of the pressure station or use the carry strap (or specified accessories) when it is moved.

To prevent damage to the PM620/PM620T module, only use the module within the specified pressure limit on the label.



**WARNING** External circuits must have applicable insulation to the mains.

This instrument uses a Lithium-Polymer (Li-Polymer) battery pack. To prevent an explosion or fire, do not short circuit, do not disassemble, and keep safe from damage.

To prevent an explosion or fire, only use the Druck specified battery (IO624-BATTERY) and power supply (IO610E-PSU) rated for this instrument.

To prevent battery leakage/damage or excess heat generation, only use the mains power supply in the ambient temperature range 0 to 45°C (32 to 113°F). The power supply input range is 100 - 240 VAC, 50 to 60 Hz, 300 mA, installation category CAT II.

Long exposure to temperature extremes will reduce battery lifetime. For maximum lifetime, avoid long periods where the battery is exposed to temperatures outside the range -20°C to +40°C. The recommended storage temperature range is -20°C to 25°C.

To make sure the display shows the correct data, disconnect the test leads before the power is set to ON or for a change to another measure or source function.

**Note:** Before an operation or procedure given by this publication is started, the user must make sure that they have the necessary skills (if necessary, with qualifications from an approved training establishment). Follow good engineering procedures at all times.

#### 1.6.4 Software Configuration and Security

Before use, make sure the relevant instrument settings are as expected. Other personnel that have access to the instrument, can have made unknown changes. Visually inspect the instrument for this type of change, before measurements are taken and calibrations done with the instrument.

### 1.7 Over-voltage Categories

The following summary of installation and measurement over-voltage categories is taken from the IEC61010-1 standard. Each over-voltage category identifies how dangerous an over-voltage transient can be.

**Table 1-1: Over-voltage Categories**

Category	Description
CAT I	This is the minimum dangerous over-voltage transient. CAT I equipment must not be directly connected to the mains power. An example of CAT I equipment is a process loop powered device.
CAT II	This is for single phase electrical installation. Examples are appliances and portable tools.

## 1.8 Product Label

**Druck**

DRUCK LTD, LEICESTER  
LE6 0FH, UK

Service / Spares:  
Druck.com/expert

1 PV624-\*\*  
2 Pressure Range:  
20 bar / 300 psi / 2000 kPa  
3 S/N \*\*\*\*\*)  
4 DoM: MM-YYYY

4 Max Working Pressure 1.2x  
5 15Vdc 30W max

Made in the UK

9 CE

10 20

11

12 UKCA

13 Bluetooth

14 Contains FCC ID: SQGBL652  
15 Contains IC: 3147A-BL652

1. Identification code of instrument
2. Max. working pressure of instrument
3. Serial number of the instrument
4. Date of Manufacture: Month, Year
5. Maximum Working Pressure is 1.2 x value of full scale pressure range
6. Current and Voltage rating for the instrument
7. Full address of manufacturer of instrument
8. Scannable QR code for web address
9. Device complies with European Union directives
10. China RoHS
11. WEEE (Recycling) Marking. Do not dispose of as normal refuse - take to an authorized disposal facility
12. UKCA Marking
13. Bluetooth compatible device
14. US FCC Radio Approval ID (Bluetooth)
15. Canada ISED Radio Approval ID (Bluetooth)

## 2. Instrument Parts

### 2.1 Introduction

This chapter identifies of the different parts of PV624 instrument.

### 2.2 PV624 Parts



Top view of Hybrid Pressure Station

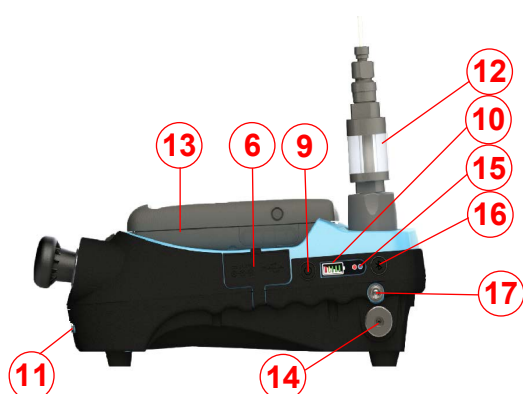

Right Side view of Hybrid Pressure Station

1.	Test port: Pressure connection (G1/8 or 1/8NPT) to attach the device under test; see Section 2.2.2.
2.	Pressure and electrical connections for a PM620/PM620T module. Seal the pressure connection with a blanking plug (111M7272-1) or a PM620/PM620T module that has the correct pressure rating.
3.	Pressure quick release knob (ON/OFF); see Section 2.2.1
4.	Molded compartment for the DPI620G calibrator with electrical connections and a mechanism to hold it in position.
5.	Push-button mechanism to release the DPI620G calibrator.
6.	Protective cover for power port and USB port
7.	Hand Pump (see Section 2.2.3 on page 8)
8.	Carrying strap with a carry handle and a shoulder strap.
9.	Power ON/OFF button (see Section 2.2.5 on page 9)
10.	Battery level indicator (One bar equals 20% charge): see Section 2.2.9
11.	Screws for removable battery cover
12.	Dirt Trap and connecting hose
13.	DPI620G instrument
14.	Barometric port (see Section 2.2.1 on page 8)
15.	Indicator lights: Status (see Section 2.2.8 on page 10) and Bluetooth (see Section 2.2.4)
16.	Bluetooth button (Section 2.2.4 on page 9)
17.	Strap Clip fastener for Carrying Strap.



## Chapter 2. Instrument Parts

---

### 2.2.1 Pressure Release Knob and Barometric Port



The pressure release knob is on the bottom right of the instrument. To release pressure, slowly turn the valve knob counterclockwise one full rotation. Make sure the system is sealed before pressure generation: fully turn the pressure release knob in the clockwise direction to close.

**Note:** The use of the pressure release knob is only necessary for the manual pressure operation - in normal operation the unit will automatically vent. It is recommended to move the unit with the pressure release knob open, to make sure that no pressure is trapped.



Barometer port

The Barometer port is inside the pressure release knob. This port is a static pressure inlet to the internal barometric pressure sensor.

The barometric port is accessible by the use of a G1/8 adapter and is in the center of the pressure relief knob. Calibration of the barometer is done through this port.

### 2.2.2 Test Port and Adapter



This image shows the PV624 “Quickfit” connector with an attached “optional (included)” G1/8 pressure adapter. This pressure adapter holds the device under test or a hose to the device.

The Test Port is at the top left corner of the instrument. Pressure can be generated and supplied to pressure devices that connect, either directly, or by the use of compatible hose fittings.

### 2.2.3 Pump (Pressure/Vacuum)

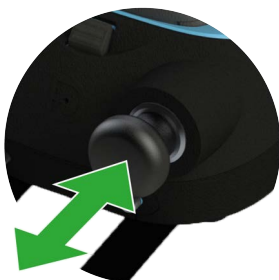

When you have set the operation mode to pressure or vacuum, seal the system (Section 3.5). Move the pump handle forwards and backwards to pressurize the instrument or make a vacuum.



## 2.2.4 Bluetooth Button



The Bluetooth button is next to the Battery Charge Indicator.

On a PV624 that has Bluetooth installed, you can disconnect the PV624 and DPI620G from each other and then push the button to select the Bluetooth mode. A wireless communication channel then becomes available.

In the Bluetooth mode you can use the DPI620G and PV624 as if they are one device, when they are less than 5m from each other.

## 2.2.5 Power Button



The Power button is on the right side of the instrument, next to the battery indicator. Push the button until the PV624 energizes (power on.)

## 2.2.6 Battery



The instrument has a chargeable Li-ion battery that is easy to remove and replace. Read the 170M2459 Quick Start and Safety manual for how to charge the battery.

## 2.2.7 Bluetooth LED

The Bluetooth LED shows the status of pairing to the DPI620G. Refer to image in Section 2.2.9. It has two different indications; Blue and Red which Table 2-1 describes.

The blue LED on the PV624 blinks fast when a Bluetooth module is available and PV624 begins pairing.

**Table 2-1: Bluetooth Indication LEDs**

Bluetooth available in PV624	Button label	Press time	LED color	LED state
Yes	Bluetooth pairing button	Between 1 and 4 seconds	Blue	Rapid blinking while connecting and continuously ON after successful pair
No	Bluetooth pairing button	Between 1 and 4 seconds	Red	Solid RED to show that Bluetooth is not available in PV624

## Chapter 2. Instrument Parts

### 2.2.8 Status LED

The status LED shows the different operational modes of the PV624. Refer to image in Section 2.2.9.

It has three different indications as described in Table 2-2.

**Table 2-2: Status Indication LEDs**

Indication	LED Color	Remarks
Status - Power ON	Green	Solid Green: When the device is powered up and idle.
Status - Unit Pressurized	Orange	When the calibration cycle is active and the device is pressurized.
Status - Error	Red	Error/Faults

### 2.2.9 Battery Level Indicator

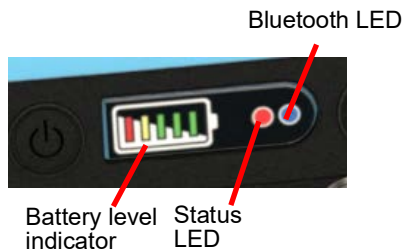

A battery level indicator is on the same side of the PV624 as the charging socket. Each segment of the indicator represents approximately 20% of the total battery capacity.

The amount of battery charge available is shown when the PV624 has power.

Battery level indicator has five different segments by which it shows the amount of charge available as shown in below table.

**Table 2-3: Battery Level Indication**

Capacity	Indicators					Type
0% - 10%	Red					ON for 5 Seconds
10% - 20%	Red	Orange				ON for 5 Seconds
20% - 45%	Red	Orange	Green			ON for 5 Seconds
45% - 70%	Red	Orange	Green	Green		ON for 5 Seconds
70% - 100%	Red	Orange	Green	Green	Green	ON for 5 Seconds

**Note:** When battery is below 10% i.e in 1st level red LED blinks for 200 ms every 4s.

## 3. Pneumatic Pressure Operation

### 3.1 Introduction



This chapter gives examples of how to connect and use the PV624 pressure station with the DPI620G, to make the necessary pressure or vacuum conditions.

Before you start:

- Read and understand the “Safety” section.
- Make sure that there is no damage to the instrument, and that there are no missing parts.

**Note:** Use only original parts supplied by the manufacturer.

### 3.2 Release the Pressure



The PV624 automatically vents the system when you push the Power button to energize (power on) or de-energize (power off) the device.

To release the pressure manually, turn the quick release knob to vent the pressure to atmosphere. Turn the pressure release knob counter-clockwise one complete rotation.

To release the pressure automatically, tap the vent  button on the pressure measurement screen of the DPI620G. Refer to screen in step 6 of Section 3.4.

### 3.3 Attach/Remove the Device Under Test



**WARNING** Pressurized gases are dangerous. Before connection or disconnection of pressure equipment, safely release all the pressure.



**CAUTION** To prevent damage to the instrument, do not let dirt get into the pressure mechanism. Before attachment of equipment, make sure it is clean.

The test port is equipped with a “Quickfit” adapter. This pressure adapter holds the device under test or a hose to the device.

You can use a flexible hose with the PV624 to connect to other equipment. Before use always visually check the hose for faults, such as splits or cuts.

## Chapter 3. Pneumatic Pressure Operation

---

### 3.3.1 Use of Blanking Plug



A blanking plug seals the test port and stops access of foreign matter into the port. It is good practice to attach the blanking plug when the test port is not in use.

To remove the blanking plug, hold the adapter firmly in one hand and turn the locking collar in a clockwise direction.

### 3.3.2 Attach an Instrument Dirt (and Moisture) Trap to the Test Port



To attach the Instrument Dirt (and Moisture) Trap (IDT) to the test port:

1. First remove the Blanking Plug if it is in the test socket: turn the locking collar clockwise to release the plug.
2. Put the IDT into the socket. Hold in position while you turn the locking collar fully counter-clockwise until it is hand tight.

### 3.3.3 Attach Device Under Test



To attach the device under test to the test port or dirt trap:

1. Put the dirt trap into the thread of the locking collar and hold in position. Turn the locking collar fully counter-clockwise until it is hand tight.
2. Make sure that the device under test is fitted with a male G3/8 Quickfit adapter thread or use a suitable adapter rated to 20 bar.

If in doubt, please contact [www.bakerhughesds.com/druck/global-service-support](http://www.bakerhughesds.com/druck/global-service-support).

### 3.3.4 Remove Device Under Test

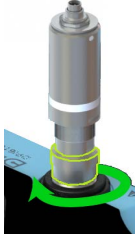

To remove a device, release the pressure first (Section 3.2):

1. To remove the device under test, hold it firmly while you turn the locking collar fully clockwise.
2. Attach the Blanking Plug to seal and protect the socket if the instrument is not required for immediate use.

3.4 Assembly Instructions

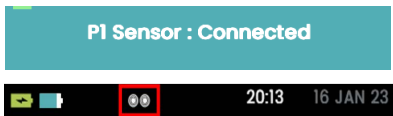
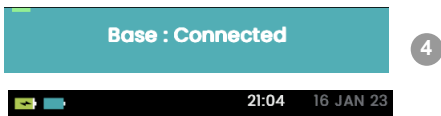

Step	Procedure
1.	Energize (power on) both devices: Push the power button on the DPI620G until the device energizes. Do this again on the PV624.
2.	Lower the DPI620G calibrator into the molded compartment.
3.	Push on the bottom end of the calibrator until it latches in position.
4.	The DPI620G screen shows this message when the device fully connects to the PV624, and communication signals occur. The DPI620G screen shows the Base Battery icon when the PV624 battery supplies power.
5.	Attach a PM620/PM620T module with the correct range and type. Put the module into the socket and hand turn the module clockwise to tighten into position. The screen will show a sensor icon when the sensor makes a connection.
6.	When the PV624 station fully connects, the DPI620G screen shows the P1 Pressure channel and its values.
7.	The whole assembly is now available for use.

### 3.5 Pressure or Vacuum Operation

After an applicable device correctly attaches to the test port (Section 3.3) and the DPI620G to the PV624 pressure station, use this procedure to set the necessary pressure or vacuum.



1

Step	Procedure
1.	Seal the system: turn the pressure release knob clockwise (1 turn).
2.	Set the control value with the Nudge up/down arrows to increase or decrease the pressure.
3.	Use the hand pump to pressurize the system. The PV624 controller will then automatically fine tune the pressure to make it increase and match to the set value. <b>Note:</b> The hand pump is disconnected and it will just pump to the atmosphere when the system reaches the set value.
4.	The reading will change to green when the pressure is stable.

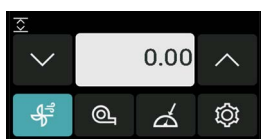

2

**Note:** Use this procedure to set a negative (-) set point to make a vacuum.

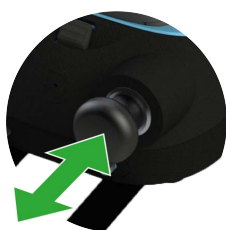

3

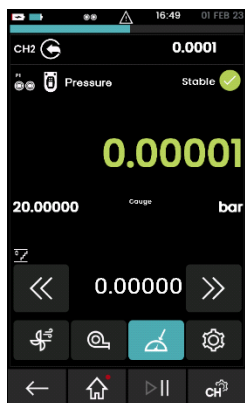

4

## 4. Pressure Calibrator Operation (DPI620G)

### 4.1 Introduction



This section gives examples of how to use the pressure station to do pressure calibrations with the DPI620G calibrator and the applicable pressure module (PM620/PM620T).

Before you start:

- Read and understand the “Safety” section.
- Do not use a damaged instrument.

**Note:** Use only original parts supplied by the manufacturer.

### 4.2 Parts and Assembly

To make a fully integrated pressure calibrator instrument, use these items:

- PV624 pressure station;
- DPI620G calibrator; see Section 4.2.1
- An applicable PM620/PM620T module for the pressure station; see Section 4.2.2.

#### 4.2.1 DPI620G Calibrator Parts

Refer to the user manual - K0541: Druck DPI620G Advanced modular calibrator.

**Table 4-1: List of Parts**



1.	Power button. Push the button and keep the button down until the device fully energizes (power on).
2.	Channel 1 (CH1) sockets for electrical measure and source operations; refer to the user manual - K0541
3.	Isolated channel 2 (CH2) sockets for electrical measure and source operations and a 24V loop power supply (24V); refer to the user manual - K0541
4.	Rubber pull-down cover for the USB type A connector; USB mini-type B connector and +5V DC power input socket.
5.	Color display with touch-screen. The number of windows you see on the display is set by the number of task selections and external modules you are working with (maximum: 6).  To select, tap on the applicable display area; refer to the user manual - K0541



## 4.2.2 PM620/PM620T Module Parts



1. Pressure module (PM620/PM620T) with a pressure connection, reference port (a) and a label. The label includes:  
*Pressure range.* Example: 20 bar g (g: gauge; a: absolute); *serial number (S/N); manufacturer:* name, address, website



**CAUTION** To prevent damage to the PM620/PM620T module, only use it within the specified pressure limit on the label.

## 4.3 Basic Channel Settings

### 4.3.1 Overview

When the PV624 and DPI620G assembly is complete (Section 3.4), use the calibrator to measure the pressure or, if applicable, the vacuum in the PV624.

Use the procedures given below to change and use the pressure channel settings:

1. Tap the **CALIBRATOR** icon.
2. Select the settings  icon to show the basic channel settings.

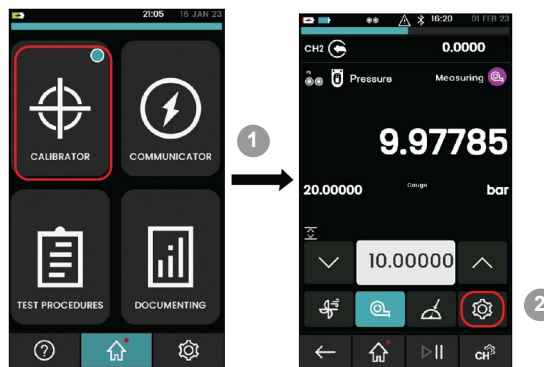

### 4.3.2 DPI620G Calibrator: Set the Pressure Units

This example shows the sequence to set the pressure units. It is a similar procedure for other units, for example **psi** and **MPa**.

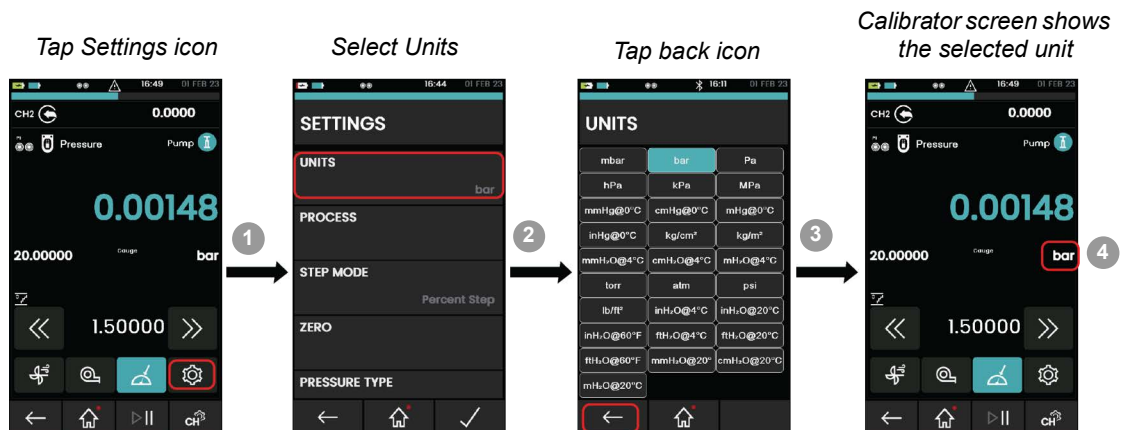

## Chapter 4. Pressure Calibrator Operation (DPI620G)

### 4.3.3 DPI620G Calibrator: Process

Process options relate to the measured values for individual channel functions. Options that are available depend on the function and include:

Option	Description
Tare	Use this option to set a temporary value for zero. This makes an adjustment to all subsequent readings on the display.
Alarm	Use to show when a limit has been exceeded.
Filter	This sets the performance band and Time constant for a low pass filter.
Scaling	Absolute values are scaled.
Flow	When selected, the square root of the measured value is shown.

For more information, refer to the K0541 manual.

This example shows the sequence to set the process options:

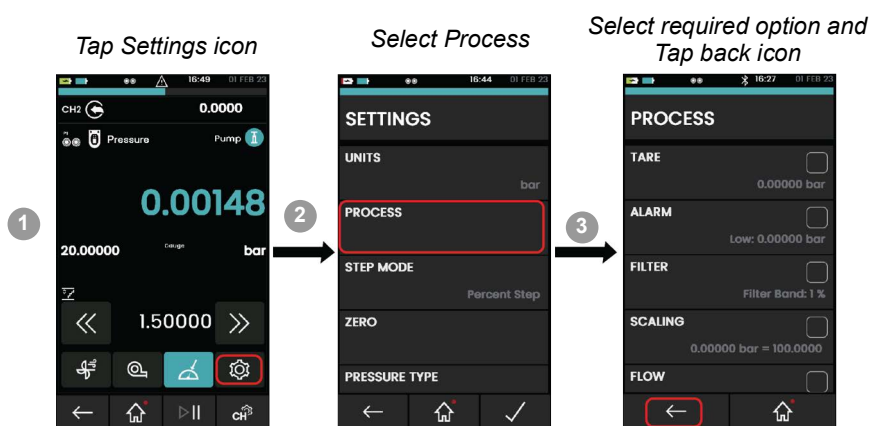

## 4.3.4 DPI620G Calibrator: Step Mode (Nudge)

This is the default Step Mode option. This lets the source value be done in increments by a set step value.

This example shows the sequence to set the Nudge step mode:

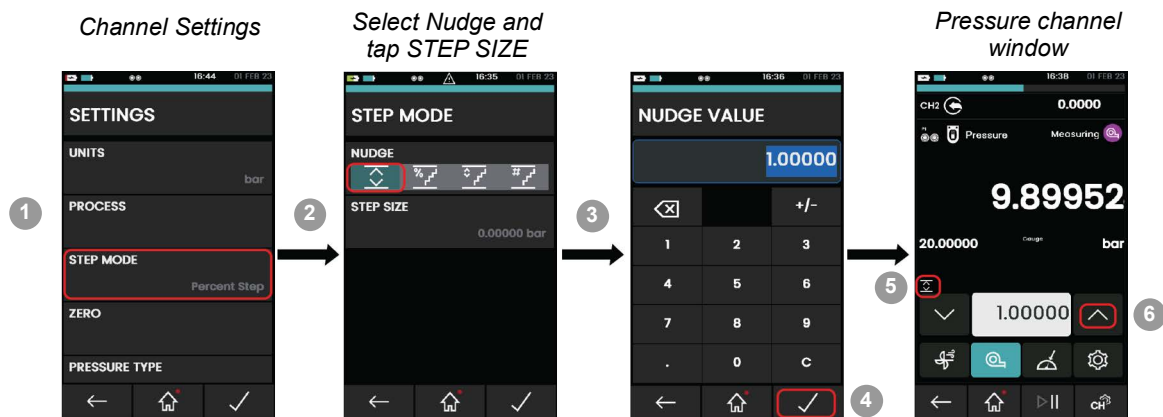

To access the **SETTINGS** menu refer to Section 4.3.1.

1. On the **SETTINGS** menu, tap the **STEP MODE**.
2. Tap the **NUDGE** option and then tap the **STEP SIZE** icon.
3. On the **NUDGE VALUE** screen, enter the specified value to set the **STEP SIZE**. For example: enter value, 1 bar, to set the Nudge value as a 1 bar step increment.
4. Tap the  icon three times to show the calibrator screen.
5. The channel screen shows the selected step size icon.
6. Tap ^ to increase the value to 1 bar, 2 bar, 3 bar etc. as an increment to value 1 from the set value.

## Chapter 4. Pressure Calibrator Operation (DPI620G)

### 4.3.5 DPI620G Calibrator: Step Mode (Percent Step)

This mode lets the source value increase in increments, in steps that relate to a set percentage of the span of values. The **LOW**, **HIGH** and **STEP SIZE** value can be set.

This example shows the sequence to set the **PERCENT STEP** mode:

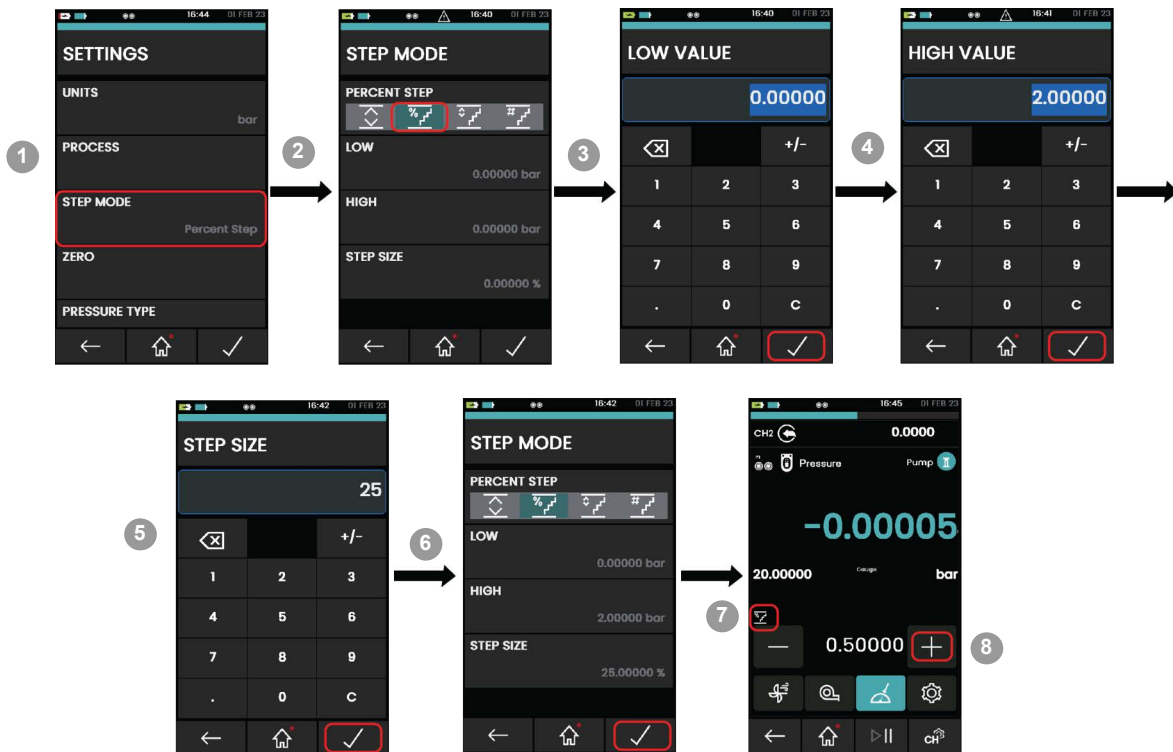

To access the **SETTINGS** menu refer to Section 4.3.1 on page 17.

1. On the **SETTINGS** menu, tap the **STEP MODE**.
2. Tap the **PERCENT STEP** option and then set the **LOW**, **HIGH** and **STEP SIZE** values. Example values are given in the procedural steps below
3. On the **LOW VALUE** screen, enter 0 and then tap the  icon. Now 0 bar is set for the low value.
4. Tap **HIGH** and enter 2 and then tap the  icon. Now 2 bars is set for high.
5. Tap **STEP SIZE** and enter 25 and then tap the  icon. 25% is set for step size.
6. Tap the  icon three times to show the calibrator screen.
7. The channel screen shows the selected step size icon.
8. Tap the **+** icon available next to set point value.

The selected **LOW** is 0 bar, **HIGH** is 2 bar and **STEP SIZE** is 25%. If you tap the **+** icon the set point value will increase by 25% from 0 until 2 bars. For example: it starts from 0.5 i.e., 25% of 2 and next value 1 bar, 1.5 bar, 2 bars.

**Note:** The Set point value will not increase more than 2 bars, because **HIGH** is set at 2 bars.

### 4.3.6 DPI620G Calibrator: Step Mode (Defined Step)

This mode lets the source value increase in set increments (steps) within the span limits. The **LOW**, **HIGH** and **STEP SIZE** value can be set.

This example shows the sequence to set the Defined step mode:

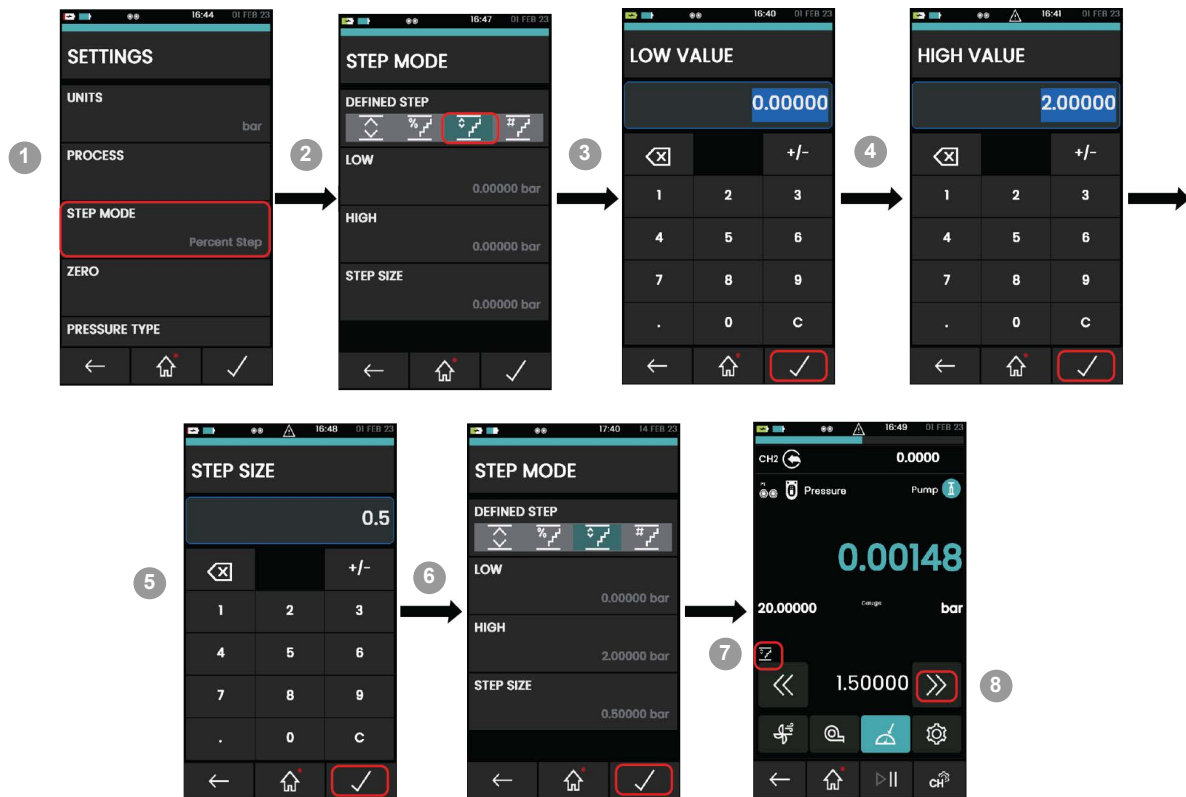

To access the **SETTINGS** menu refer to Section 4.3.1 on page 17.

1. On the **SETTINGS** menu, tap the **STEP MODE**.
2. Tap the **DEFINED STEP** option and then set the **LOW**, **HIGH** and **STEP SIZE** values. Example values are given in the procedural steps below.
3. On the **LOW VALUE** screen, enter 0 and then tap the  icon to set the **HIGH** value to 2.
4. Tap **HIGH** and enter 2 and then tap the  icon. Now 2 bars is set for high.
5. Tap **STEP SIZE** and enter 0.5 and then tap the  icon. 0.5 bar is set for step size.
6. Tap the  icon three times to show the calibrator screen.
7. The channel screen shows the selected step size icon.
8. Tap the >> icon available next to set point value.

The selected **LOW** is 0 bar, **HIGH** is 2 bars and **STEP SIZE** is 0.5. When you tap the >> icon the set point value increases by six different values. For example: the value starts from -0.5 bar then increases by 0.5 bar for each step, up to 2 bars. This lets you calibrate the system with six different set point values.

**Note:** The Set point value will not increase more than 2 bars, because **HIGH** is set at 2 bars.

## Chapter 4. Pressure Calibrator Operation (DPI620G)

### 4.3.7 DPI620G Calibrator: Step Mode (Point Step)

This mode makes the source value increase and decrease in a set number of points. When Direction is set to **Up** the number of points will increase from **LOW** to **HIGH**. When Direction is set to **Down**, the number of points will be from the **HIGH** to **LOW** value.

This example shows the sequence to set the Point step mode:

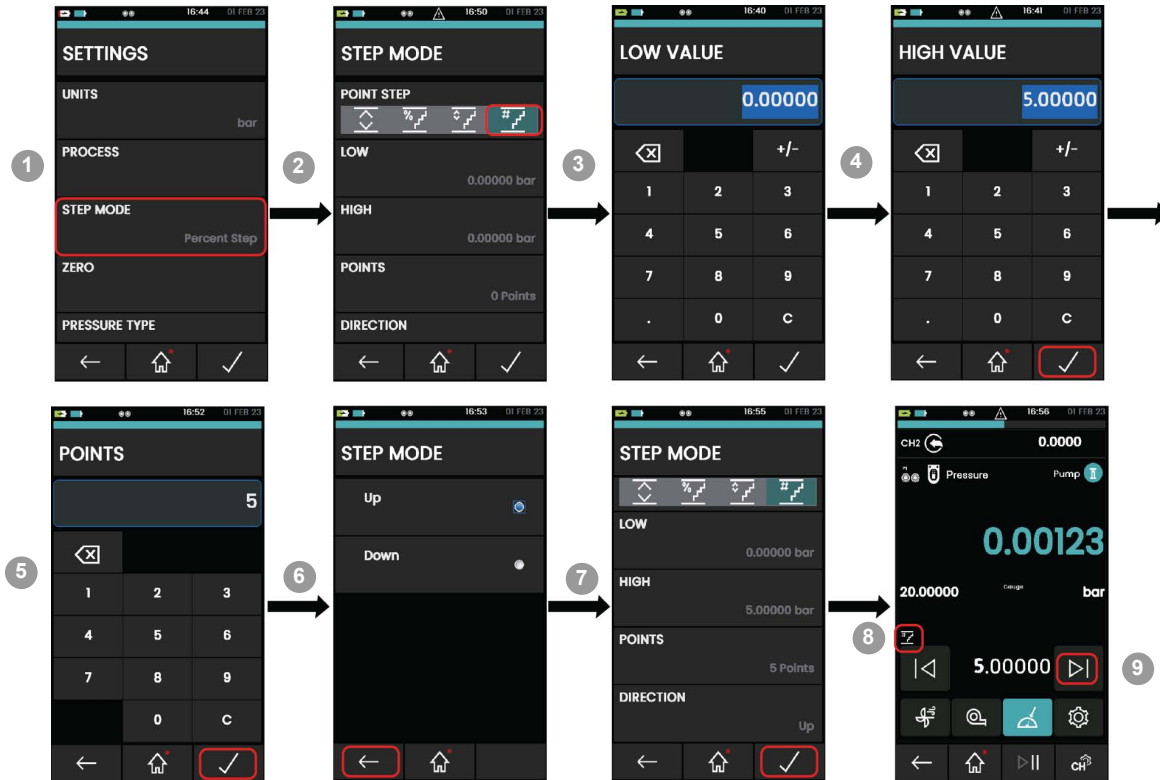

To access the **SETTINGS** menu refer to Section 4.3.1.

1. On the **SETTINGS** menu, tap the **STEP MODE**.
2. Tap the **POINT STEP** option and then set the **LOW**, **HIGH**, **POINTS** and **DIRECTION** values. Example values are given in the procedural steps below.
3. On the **LOW VALUE** screen, enter 0 and then tap the  icon: 0 bar is set for the low value.
4. Tap **HIGH** and enter 5 and then tap the  icon to set the **HIGH** value to 5.
5. Tap **POINTS** and enter 5 and then tap the  icon to set 5 points for **POINTS**.
6. Tap **DIRECTION** and select **UP** and then tap on icon to set **UP** for the direction.
7. Tap the  icon three times to show the calibrator screen.
8. The channel screen shows the selected step size icon.
9. Tap the  icon to set point value.

The selected **LOW** is 0 bar, **HIGH** is 5 bar and **POINTS** is 5 (the **POINT** value can be from 1 to 25.) In this example, when you tap the next icon the set point value will increase by 1 bar. This lets calibration of the system be done by the point increments.

The Set point value will not increase more than 5 bars, because **HIGH** is set at 5 bars.

**Note:** A set point pressure value must be in full units, for example, 1 bar, 2 bar.

### 4.3.8 DPI620G Calibrator: Set the PM620/PM620T Module to Zero

Use this option to write a new zero pressure value to the PM620/PM620T module in use. This option only affects gauge type modules.

It is recommended that all gauge sensors are zeroed at the start of each day before use.

This example shows the sequence to set the Point step mode:

To access the **SETTINGS** menu refer to Section 4.3.1.

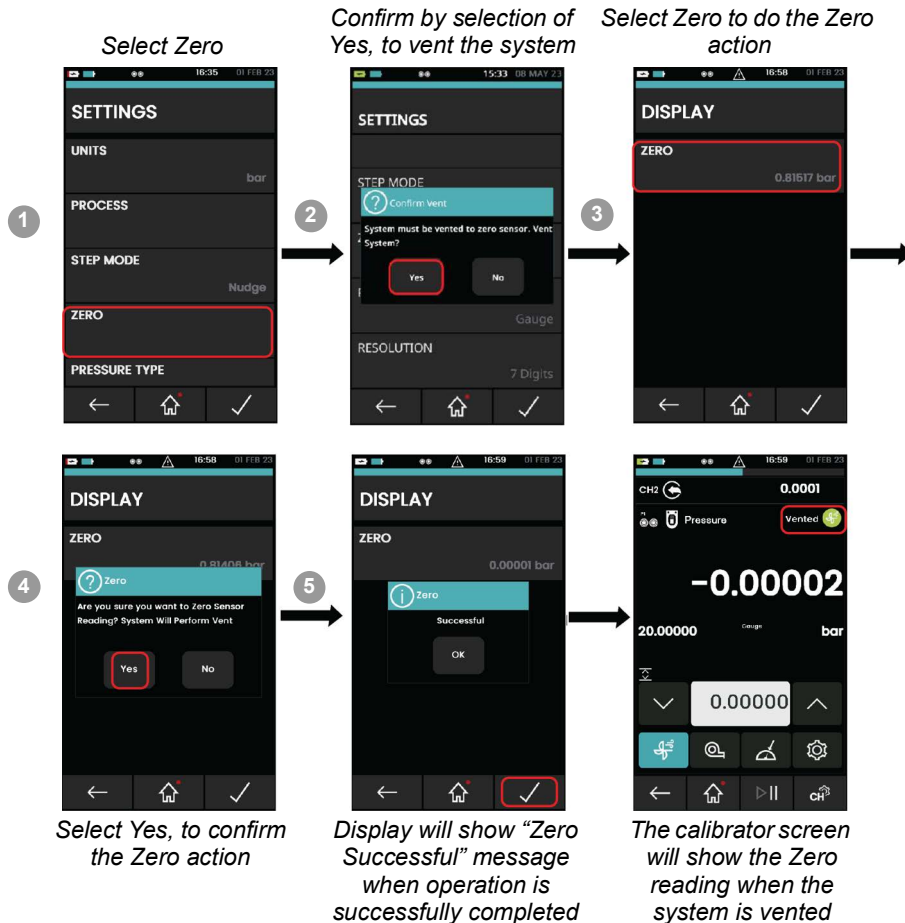

**Note:** To make a temporary adjustment for zero, you can use the Tare function: Select Settings > Process > Tare (refer to the user manual - K0541).

**Note:** A Zero Error can occur if the pressure indication measured from the sensor, is more than 1% of the full-scale value when the instrument pressure port is opened to atmosphere.



# Chapter 4. Pressure Calibrator Operation (DPI620G)

## 4.3.9 DPI620G Calibrator: Set the Pressure Type

There are two types of pressure sensor: Gauge and Absolute. Both sensors can be set up to use a Pseudo mode. The Pseudo mode combines the original sensor type and barometric reading from the PV624, to show the Pseudo pressure reading (Pseudo-abs/Pseudo-gauge). For reference, the barometric reading is shown in Pseudo mode. From the Pressure Type settings, the option is available to show the barometric reading as the primary reading.

To select the pressure type use this procedure:

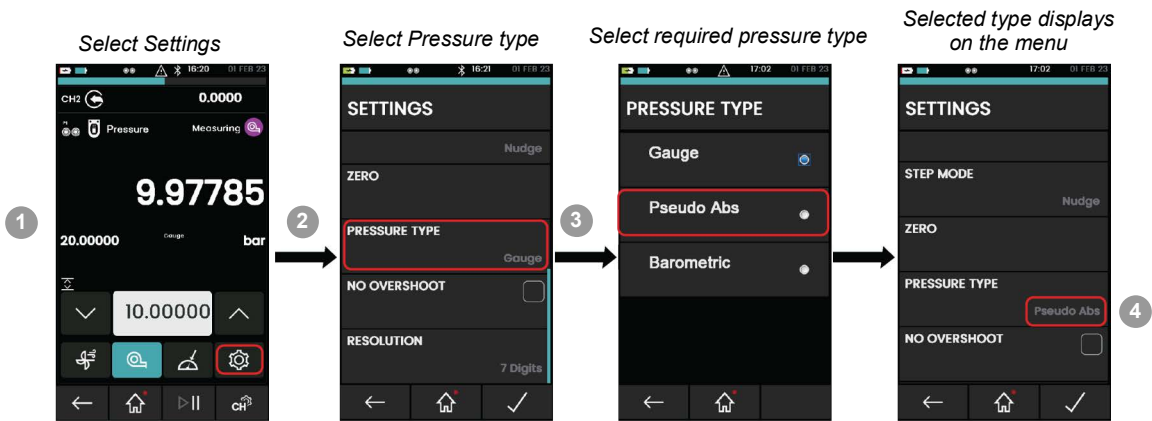

## 4.3.10 DPI620G Calibrator: Resolution

Use this option to change the set point value on the calibrator screen to be seen in the range of 4 to 7 digits.

**Note:** The resolution is the maximum number of digits available to show a value. The full scale value also affects the value shown. For example, if 20 bar is the full scale value and the resolution is set to 7. A measured value of 10 bar will be shown as 10.00000 (7 digits). If 20 bar is the full scale value and the resolution is set to 5 digits, a measured value of 10 bar will be shown as 10.000 (5 digits). If the full scale value is 20 bar, resolution is 7, a measured value of 1 bar will be shown as 1.00000 (7 digits are available but only 6 digits are necessary to show the value).

This example shows the sequence to set the Resolution:

To access the **SETTINGS** menu refer to Section 4.3.1.

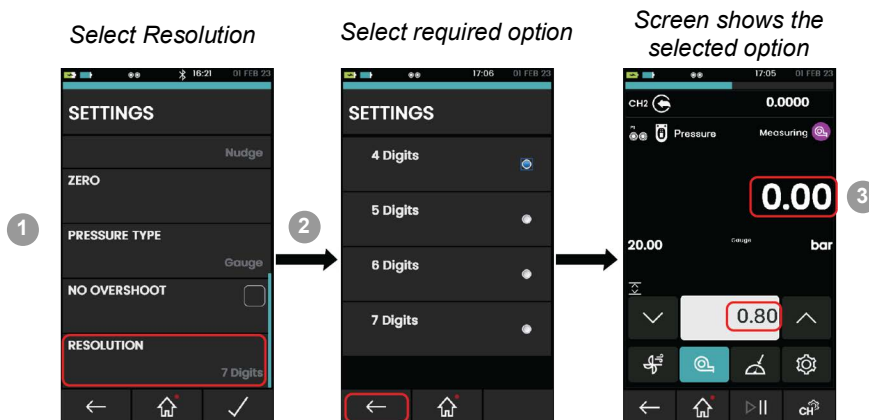



### 4.4 Utility (Channel Settings)

The Tasks menu  gives access to these utilities shown below:

#### 4.4.1 DPI620G Calibrator: Set the Pressure Function

This example shows the sequence to set the pressure function. It is a similar procedure for other functions; refer to the user manual - K0541.

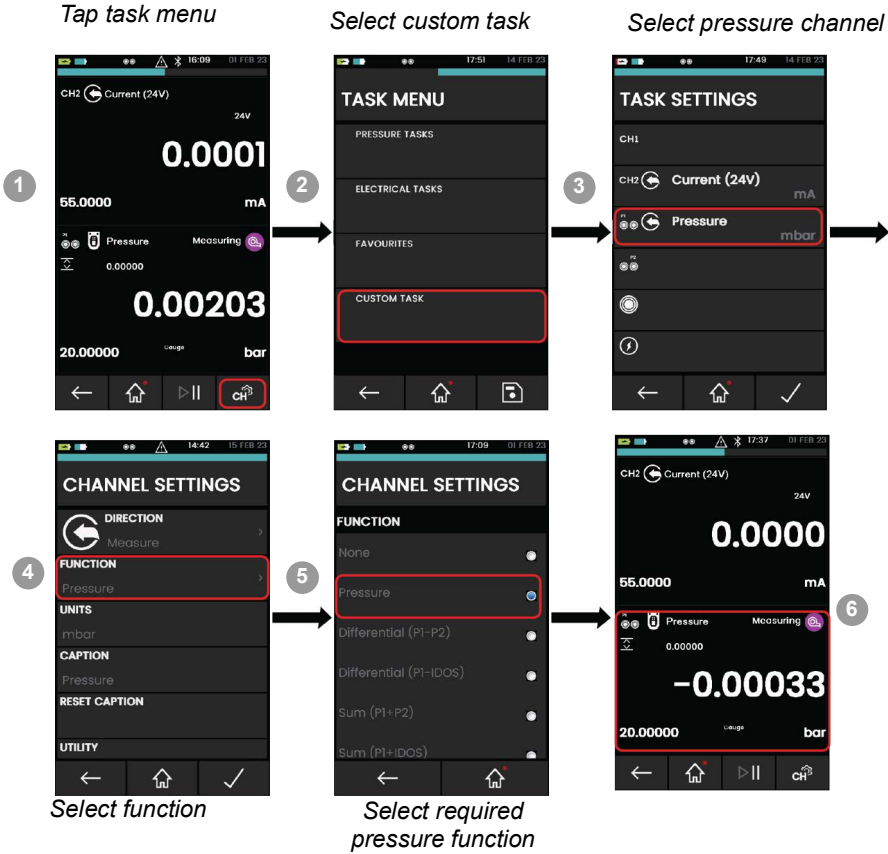

# Chapter 4. Pressure Calibrator Operation (DPI620G)

## 4.4.2 DPI620G Calibrator: Set the Pressure Units

This example shows the sequence to set the pressure units.

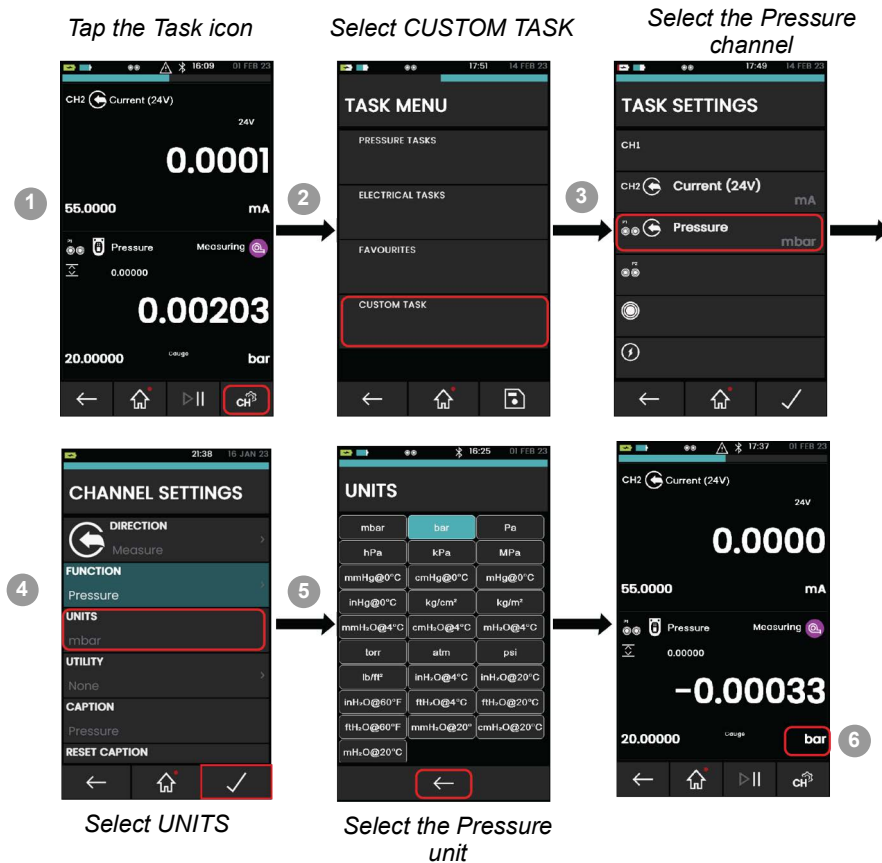

## 4.4.3 DPI620G Calibrator: Set Up a Leak Test

It is recommended a Leak Test be done before the completion a PV624 calibration or operation. This is to be sure the pressurized system and associated components will not leak.

When a Device Under Test (DUT) connects to the PV624 pressure test port (either directly or with hoses and auxiliary connections) there can be leaks.

In a Leak Test, you apply pressure (or vacuum) to the system (typically not exceeding 10% of the sensor working pressure) and make a record of pressure changes in this test.

To do a leak test, set the *Utility* to *Leak Test* and then set the *Leak Test* options in *Settings*:

1. Set the Utility

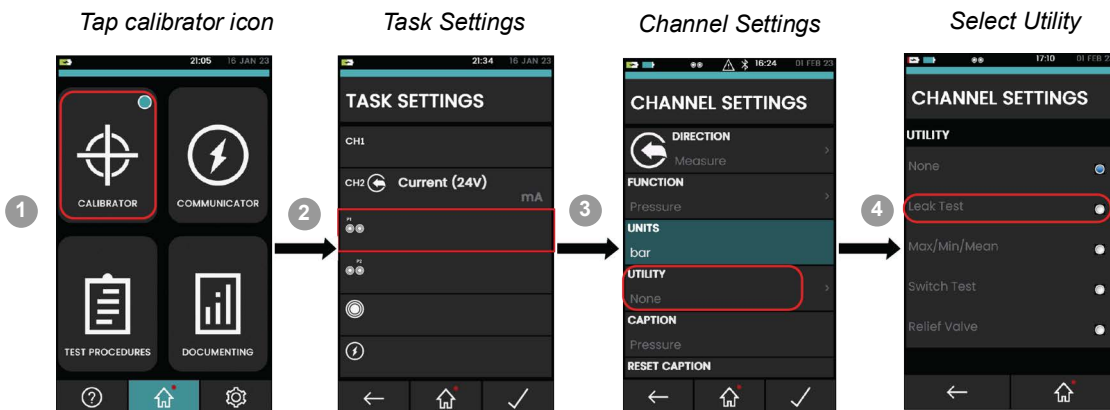

## 2. Set the Leak Test options

When you have set the *Utility* to *Leak Test*, you can use these options from the *Channel Settings* (See “Basic Channel Settings” on page 17.):



### a. WAIT TIME

Before you start a Leak test, you must let the pressurized system become stable before the test starts. The time for this is the **WAIT TIME** on the PV624. The time before the test starts is in hours:minutes:seconds (hh:mm:ss)

### b. TEST TIME

This is the period in which a change in pressure in the PV624 is to be recorded. The period of the leak test is in hours:minutes:seconds (hh:mm:ss)

**Note:** To set the Leak Test options, you must have a PM620/PM620T module correctly installed (Section 4.3 on page 17).

3. Set the PV624 to a pressure point and make sure pressure is stable.
4. Tap the **PLAY**  icon to start the Leak test. **Start** pressure is recorded when the **TEST** time starts after the **WAIT** time.
5. If necessary, tap the **STOP**  icon to stop the Leak test with no results.
6. When the **TEST TIME** countdown is complete, the **End** pressure value is recorded and the Leak Rate per minute is calculated and shown as the Leak test result.

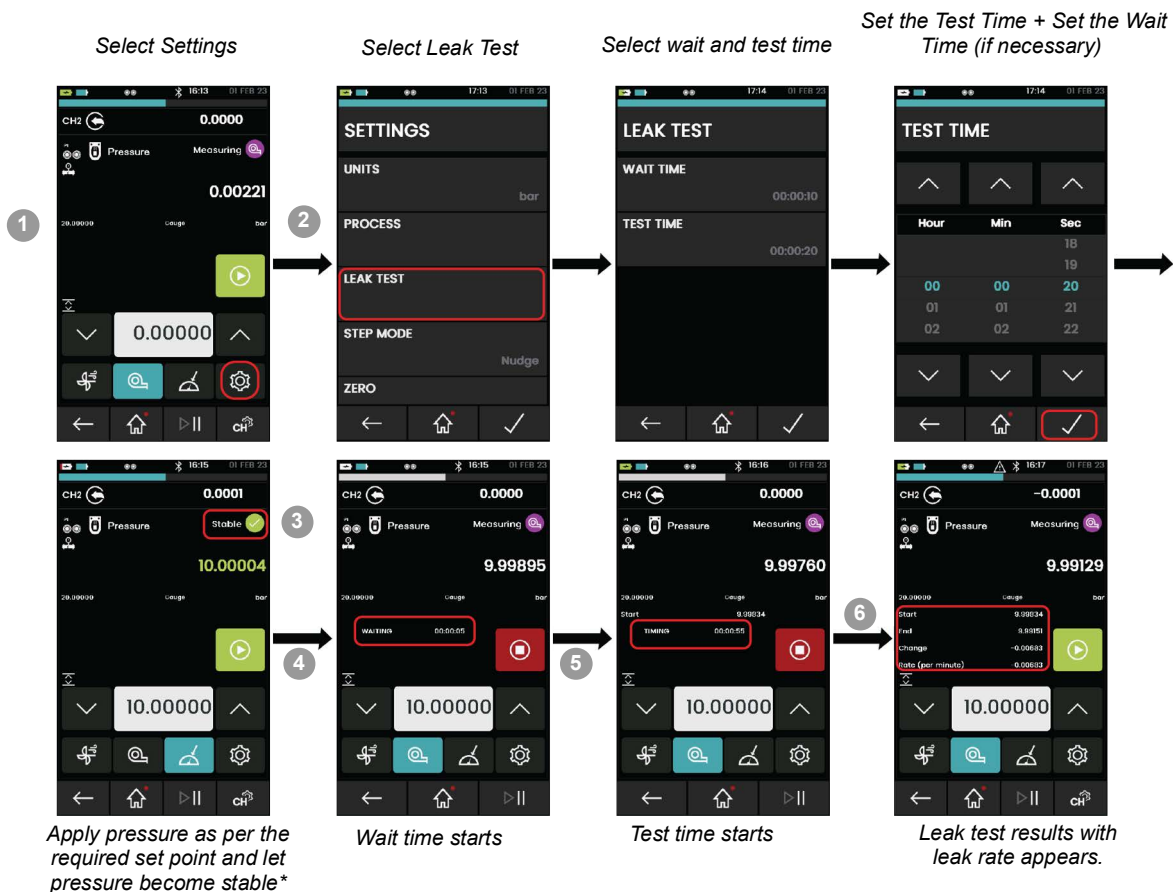

\* The user must set a control point for the pressure to stabilize. A control point must be set to let a leak test to start.

## Chapter 4. Pressure Calibrator Operation (DPI620G)

### 4.4.4 DPI620G Calibrator: Set Max/Min/Mean Test

When you select this utility, the real-time minimum, maximum, and average values of the measured signal is shown in addition to the live measured reading. For more information refer to the user manual - K0541.

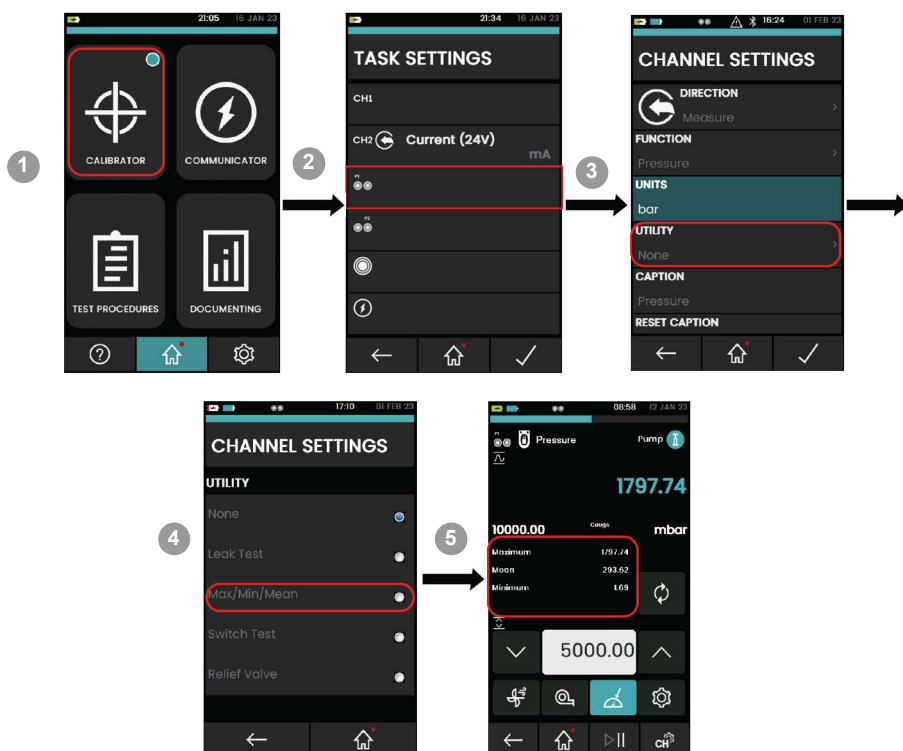

### 4.4.5 Example Procedure: Relief Valve Test

Pressure relief valves are safety devices that open automatically at a specified pressure to prevent over-pressure conditions in connected equipment. The Relief Valve Test measures the actuation pressure of pressure relief valves.

The user selects either rising or falling mode operation to test positive or negative pressure relief devices. The user then pumps the device up to the actuation pressure. The utility reports maximum or minimum actuation pressure of the test device. Refer to the DPI620G user manual - K0541 for more information.

**Note:** To get the best measurement accuracy, pump slowly when the valve is close to the necessary actuation pressure.

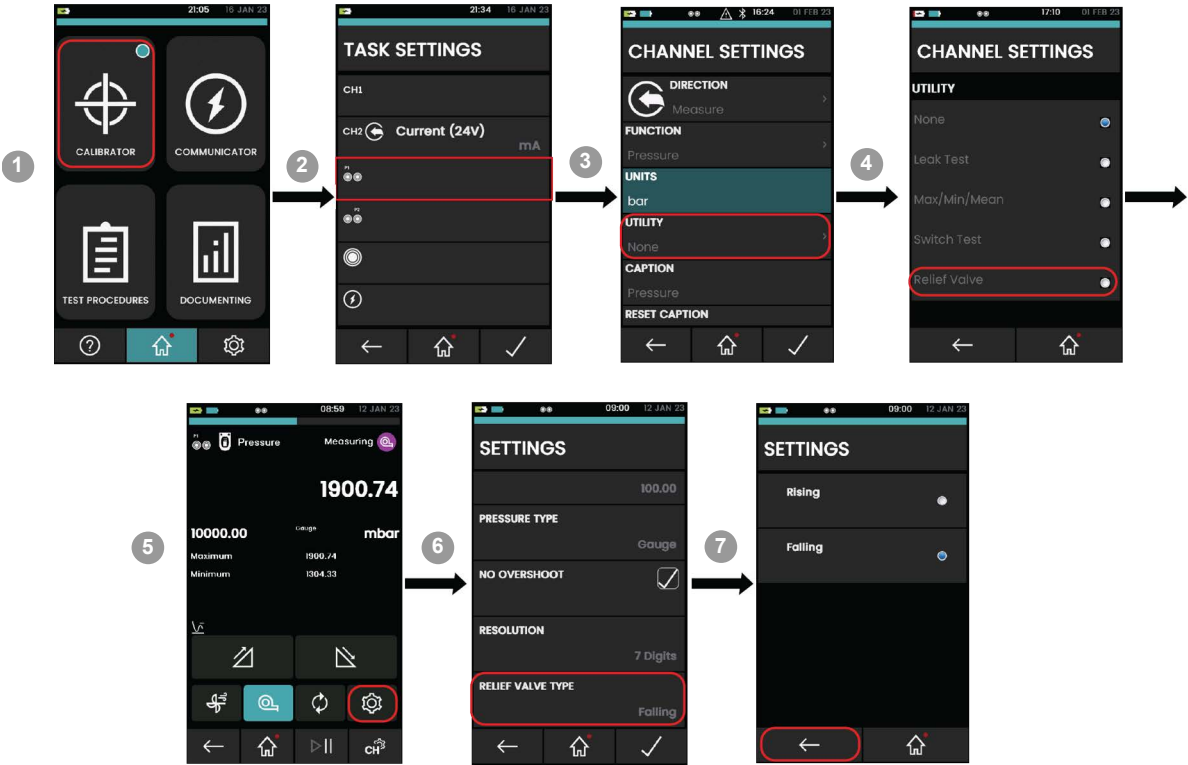

## Chapter 4. Pressure Calibrator Operation (DPI620G)

### 4.4.6 DPI620G Calibrator: Set Up a Switch Test

Pressure switches open or close an electrical circuit when the applied pressure exceeds a specified threshold. Hysteresis is the difference between the applied pressures that start and reset the pressure switch, as illustrated in Figure 4-3.

The switch-test utility measures the actuation pressure and hysteresis of a pressure switch. The actuation pressure measurement uses the hand-pump to generate either pressure or vacuum while monitoring the state of the switch and applied pressure. After actuation, the switch hysteresis is measured by slowly venting the applied pressure until the switch changes state again.

With the PV624, the switch hysteresis may be measured automatically by specifying the switch test accuracy (see Figure 4-3), but the actuation pressure measurement requires pump assistance.

When pumping close to the actuation pressure of the switch, it is advisable to slowly decrease the pump rate. Do this, to achieve the most accurate measurement of actuation pressure. For example, to achieve an actuation pressure accuracy of 10 mbar: set the switch test accuracy value to 10 mbar/s and the pump rate to be no faster than 100 mbar/s.

#### **Example Procedure: Switch Test**

This example shows the procedure to perform the switch test.

Refer to the Figure 4-1: Switch testing setup for an example of the physical connections necessary for a switch test.



**Figure 4-1: Switch testing setup**

**Note:** The Switch test is available with measure or source functions.

#### **4.4.6.1 Switch Test Procedure**

Before the start of the procedure on the next page, make sure the accuracy of the switch test is correct. An increased value reduces the test time but can make a less accurate capture of switch and overall hysteresis.

If a different accuracy value is necessary, tap the **SETTINGS** icon to show the **SETTINGS** screen that has the **SWITCH TEST ACCURACY** function (refer to Figure 4-2 on page 31).

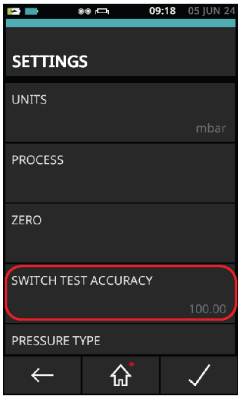

Figure 4-2: Switch test accuracy setting

Refer to Figure 4-3 for the screens to which these instructions relate:

1. Select **CALIBRATOR** on the dashboard.
2. Select the **P1** channel on the **TASK SETTINGS** screen.
3. Select **UTILITY** on the **CHANNEL SETTINGS** screen.
4. Select **SWITCH TEST**.
5. Tap the **RAMP UP** icon to set the PV624 in Pump mode.
6. Move the hand pump to increase the pressure. Use smaller pump movements as the necessary pressure is approached, until the switch operates (open or closed).
7. The PV624 goes into measure mode: the rising switch pressure (Opened At or Closed At) will be recorded.

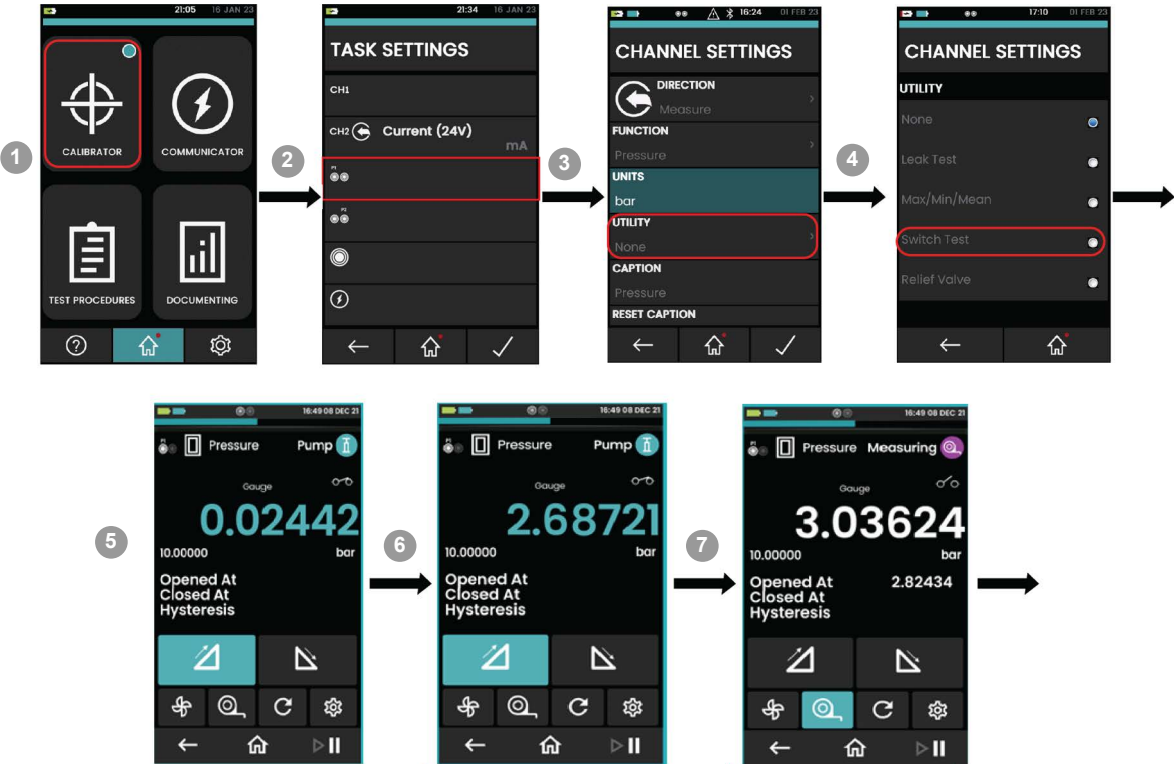
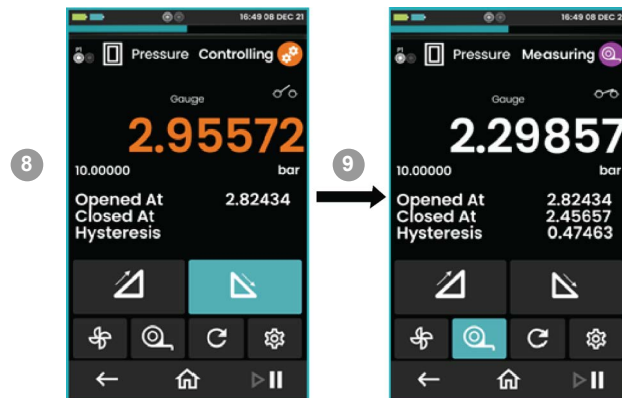



Figure 4-3: Switch test example



**Figure 4-3: Switch test example (Continued)**

8. Tap the **RAMP DOWN**  icon to decrease pressure in the PV624. Refer to Figure 4-2 on page 31 for the set accuracy (measured in bar.)  
The display shows:
  - Open and closed switch pressure values.
  - Hysteresis value.
9. Let the pressure decrease until the switch state is recorded. When this occurs, the PV624 will go into measure mode: the falling switch state is recorded (Opened At or Closed At). The hysteresis is calculated and shown.

If necessary, to do the test again, tap the **Reset**  button.



## 4.5 Settings Menu

Use the Settings  menu to access the **STATUS**, **CONNECTIONS** and **ADVANCED** sub menu.

### 4.5.1 Overview of Settings Menu

The **STATUS** menu has the option to view the **BASE** and **BAROMETER** status and data.

The **CONNECTIONS** menu has the option to view the Bluetooth connection data.

The **ADVANCED** menu has the option to do the barometer calibration of PV624 and to adjust the barometer calibration dates.



### 4.5.2 DPI620G Calibrator: View the Base Battery Status

This example shows the sequence to view the **BASE BATTERY STATUS**. Scroll down the status menu list to view the **BASE BATTERY STATUS** option.

To access the **STATUS** menu refer to Section 4.5.1 on page 33.

For other status options refer to the user manual - K0541.

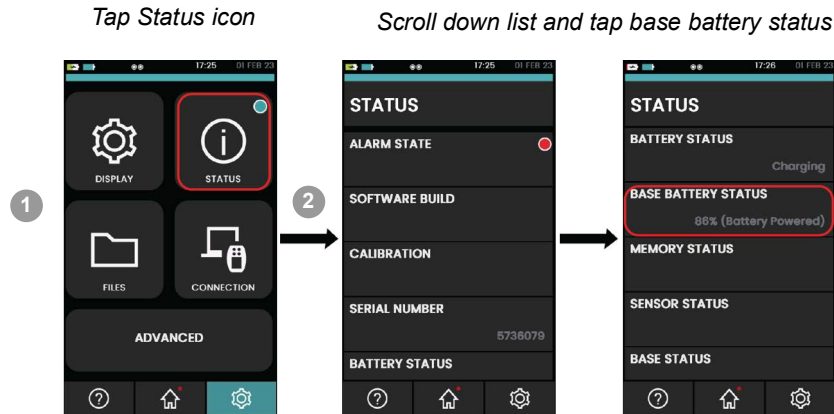

# Chapter 4. Pressure Calibrator Operation (DPI620G)

## 4.5.3 DPI620G Calibrator: View the Base Status and Barometer Status

This example shows the sequence to see the **BASE** and **BAROMETER STATUS**. To access the **STATUS** menu refer to Section 4.5.1 on page 33.

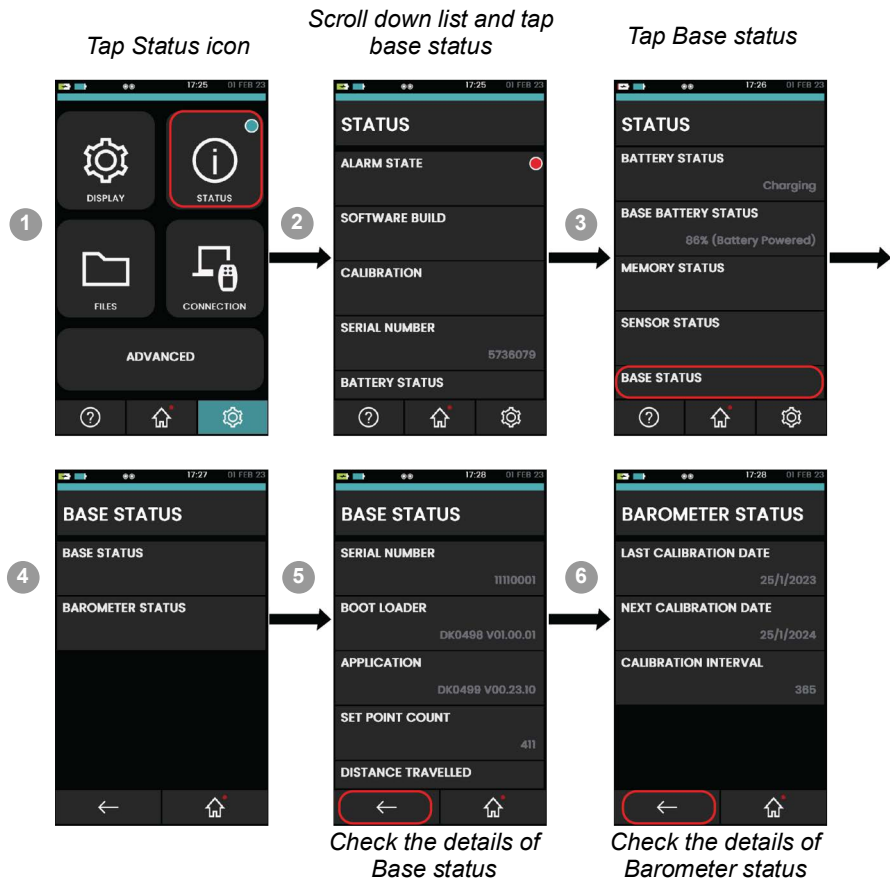

#### 4.5.4 DPI620G Calibrator: Connect PV624 via Bluetooth

This example shows the sequence to use Bluetooth to connect the DPI620G to the PV624.

The Bluetooth option in PV624 lets signals move between the device and the DPI620G, with no physical connection. Calibration tasks are possible when Bluetooth communication is used.

To access the **CONNECTIONS** menu refer to Section 4.5.1.

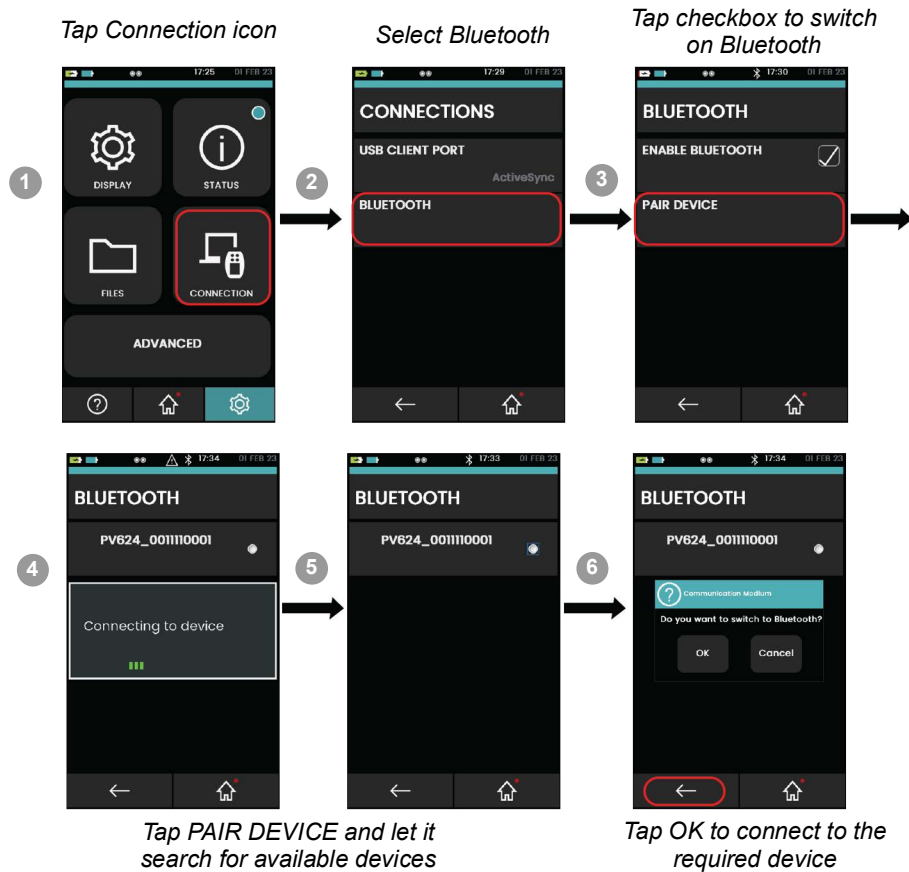

**Note:** In case the wrong device is paired via Bluetooth, then reset the device and start the pairing process again.

To disconnect from the Bluetooth connection:

1. Select the connected PV624 from the **Connections > Bluetooth** menu. Confirm the disconnection from the device.
2. To cancel Bluetooth, click in the checkbox for the **Enable Bluetooth** option to remove the tick mark in it.

# Chapter 4. Pressure Calibrator Operation (DPI620G)

## 4.5.5 DPI620G Calibrator: Adjust the Barometer Calibration Date and Interval

This example shows the sequence to set the barometer calibration date and interval. To access the **ADVANCED** menu refer to Section 4.5.1 on page 33.

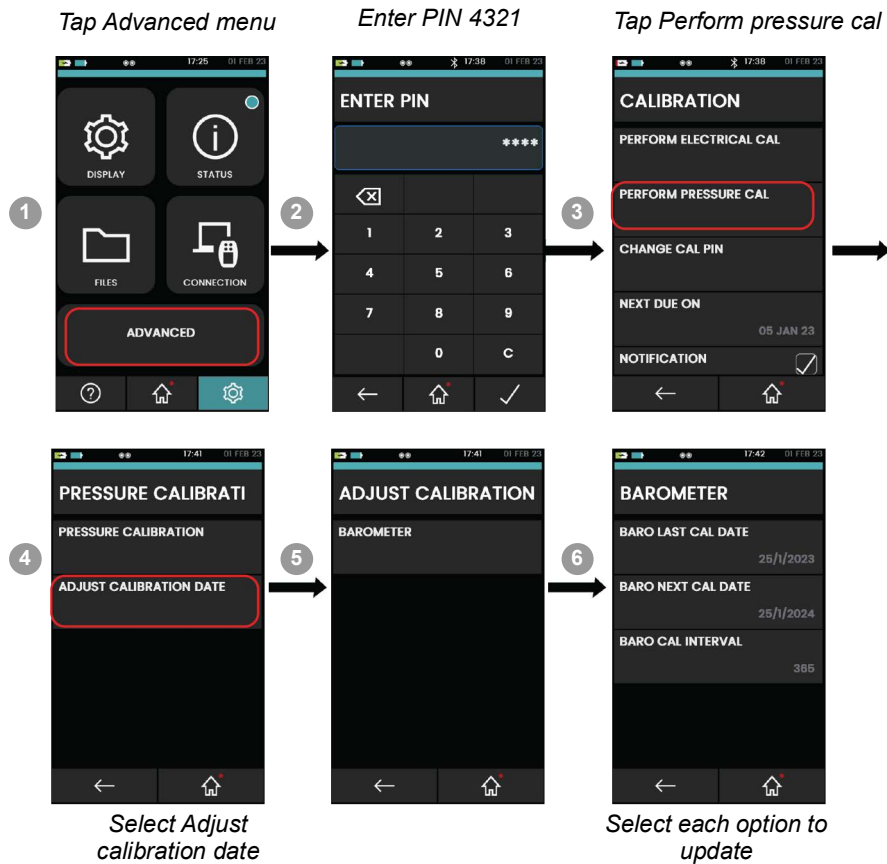

1. To change the **BARO LAST CAL DATE**.
  - a. Tap **BARO LAST CAL DATE** to open the **DATE** screen.
  - b. Select Day, Month, and Year, as necessary, to change the value move through the list of the variable.
  - c. Tap the  to set the changes.

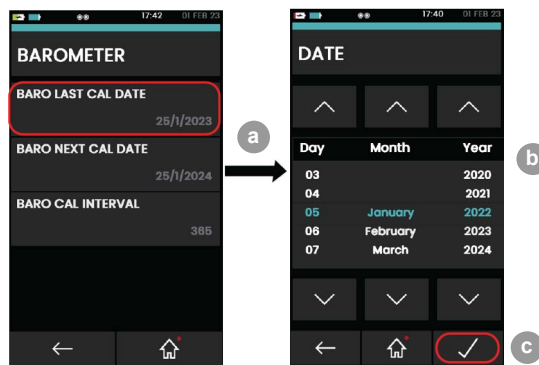

2. To change the **BARO NEXT CAL DATE**.
  - a. Tap **BARO NEXT CAL DATE** to open the **DATE** screen.
  - b. Select Day, Month, and Year, as necessary, to change the value, move through the list of the variable.
  - c. Tap the  to set the changes.

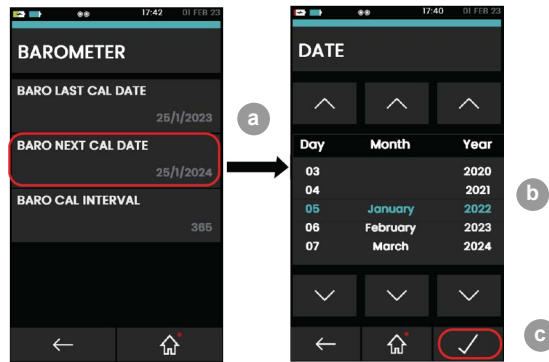

3. To change the **BARO CAL INTERVAL**.
  - a. Tap **BARO CAL INTERVAL** to set the number of days.
  - b. Set the necessary number of days.
  - c. Tap the  to set the changes.

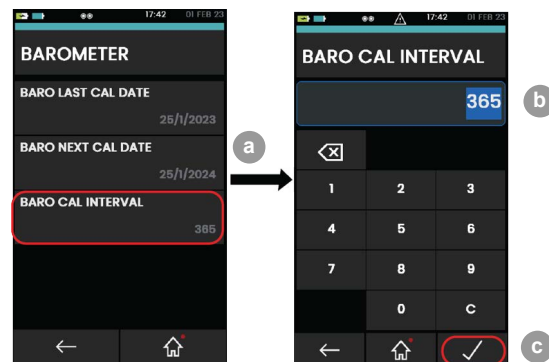

#### 4.5.6 Example Procedure: Barometer Calibration

This example shows the procedure to calibrate the internal barometer.

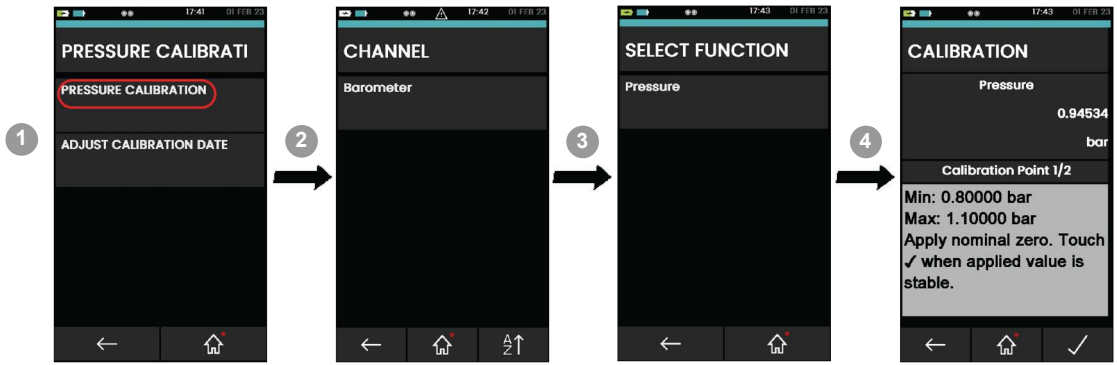

**Figure 4-4: Barometer calibration setup**

To calibrate the internal barometer sensor of the PV624, make sure the correct pressure connection (refer to “Pressure Release Knob and Barometric Port” on page 8) is made from the barometer port to the external calibrated pressure source. Only approved service centers and approved personnel can do this sensor calibration.

Access to the **PRESSURE CALIBRATION** screen as shown in Section 4.5.5 on page 36.

# Chapter 4. Pressure Calibrator Operation (DPI620G)



CALIBRATION - Barometer screen has two sections. The top section shows the read value from the internal PV624 barometer.

The below calibration point section gives the following information:

- Function minimum range (or negative full-scale) value.
- Function maximum range (or positive full-scale) value.
- Calibration procedure step status (visual status boxes and text status).
- User instructions for each step of the procedure.

**Note:** Two valid calibration points are necessary for Barometer sensor calibration.

Use the following steps on the DPI620G screen to calibrate the internal barometer:

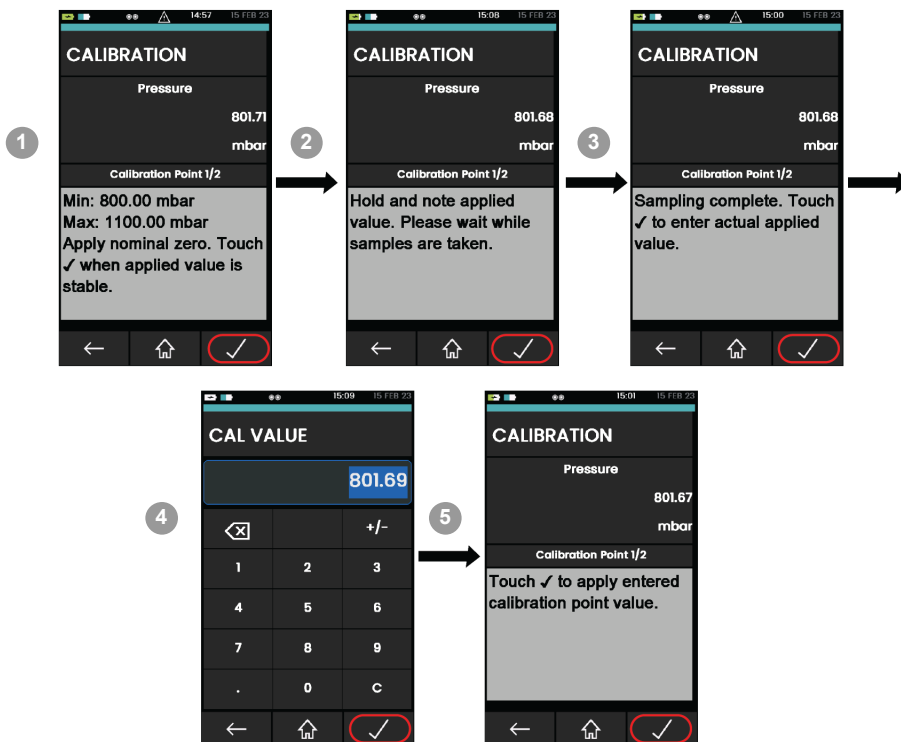

1. Use an external calibrated source of pressure to supply the 800 mbar pressure for the first set point value. Wait for the pressure to become stable. When it becomes stable (between 799.5 mbar to 800.5 mbar) on the external pressure source, tap the  icon to continue.
2. The screen will show the message “Hold and note applied value. Please wait while samples are taken”. After this, the message changes to “Sampling complete. Touch the  icon to enter the measured applied value”. Tap the  icon to show the **CAL VALUE** screen.

- The **CAL VALUE** screen shows the stable measured value. You can use the value read on the external pressure source to change this value: tap the  icon to continue with this measured value. The screen shows the message “Touch  to apply entered calibration point value”.
- Tap  icon to complete Calibration point 1 and go to the production of Calibration point 2.

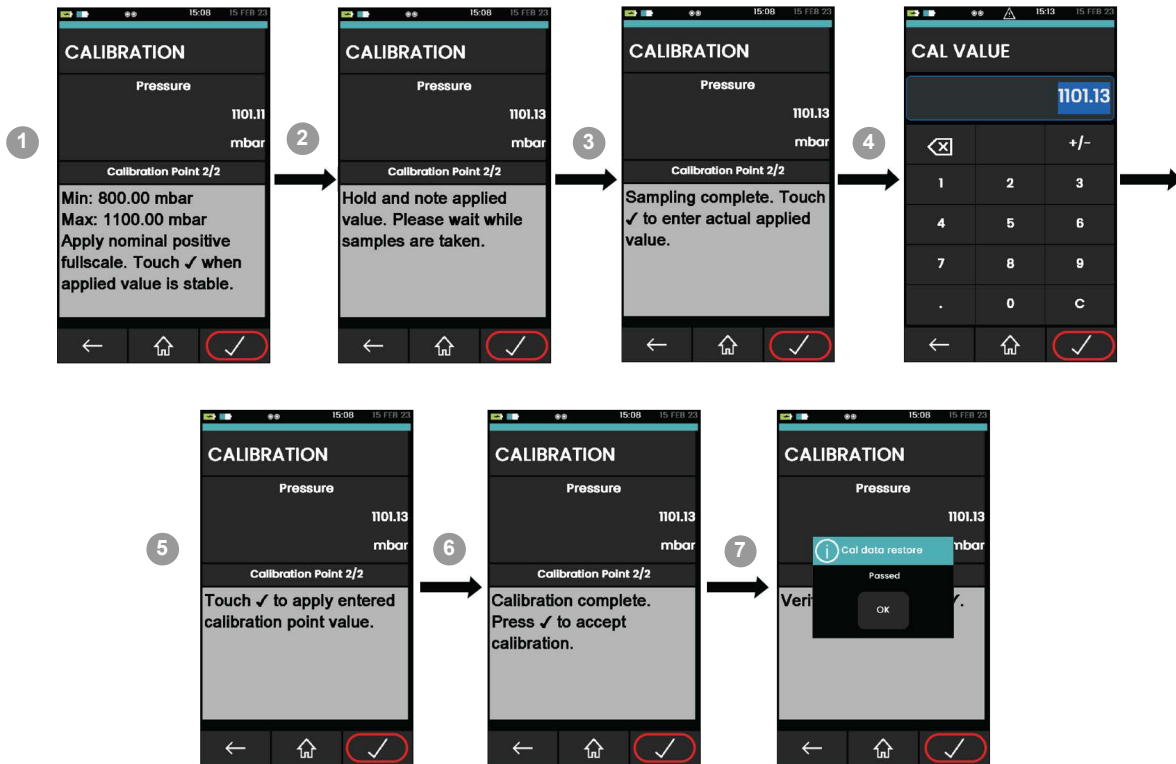



- Follow Steps 5 to 7, but to begin, use the nominal positive full-scale pressure to the DPI620G.
- Supply pressure at 1100 mbar for the second point.
- When the measured Pressure indication is stable between 1099.5 mbar to 1100.5 mbar, tap  icon to continue. The Calibration procedure is complete.
- When you accept readings on the external pressure source for both set points, the screen shows “Calibration complete. Tap  to accept the calibration”.

After you tap the  icon in the previous step the screen shows a message window. This window shows that calibration is “Accepted”. Tap **OK** to show the **Pressure Calibration** screen.

## 5. Help Menu

### 5.1 Overview

The Help  menu provides related information on how to use the instrument. Tap the  icon on the dashboard to access the help menu.

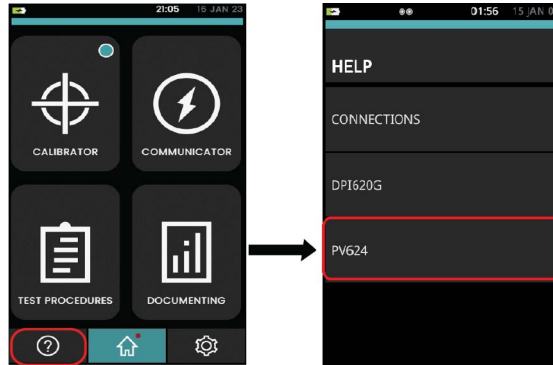

All the information necessary to operate the PV624 and DPI620G is in this menu and gives the following options.

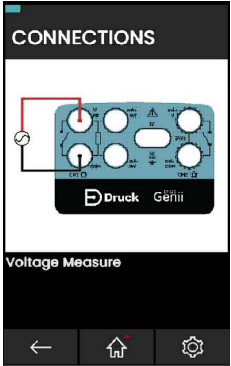
Option	Description
Connections	<p>Tap this menu row to show images that give the correct electrical connections for different individual functions. Swipe left or right to view the different diagrams available.</p> 
DPI620G manual	<p>Tap this menu row to show these selections:  <b>VIEW ONLINE</b> shows a QR code. Use mobile phone to scan the code to access the Help system.  <b>VIEW DPI620G MANUAL</b> shows the contents of an online Help document.  <b>IMPORT FROM USB</b> imports the Help document into the device memory from an USB memory stick.</p>
PV624 manual	<p>Tap this menu row to show these selections:  <b>VIEW ONLINE</b> shows a QR code. Use mobile phone to scan the code to access the Help system.  <b>VIEW PV624 MANUAL</b> shows the contents of an online Help document.  <b>IMPORT FROM USB</b> imports the Help document into the device memory from an USB memory stick.</p>



## 6. Maintenance Procedures

### 6.1 Introduction

This chapter gives procedures for the maintenance of the instrument and to keep it in a good condition. Send the instrument to the manufacturer or an approved service agent for all repairs. Table 6-1 summarizes manufacturer recommended maintenance tasks for the PV624.

**Table 6-1: Maintenance tasks**

Task	Period
Visual Inspection	Before each use
Cleaning	Determined by usage
Calibration	12 months (recommended)

### 6.2 Service and Repair



**WARNING** Service or repair of equipment can cause damage to property and dangerous injuries to personnel (including death). It is important that service and repair are only done by a Druck approved service provider.

Repair activities done by personnel not approved for this work, will cancel the equipment warranty. Druck cannot be held liable for damage (this includes damage to the equipment), monetary fine or personal injury (including death) that can occur during or as a result of service maintenance or repair work undertaken by a not approved service provider.

Internal components, such as the Lithium battery pack, can become pressurized or create other dangers if not used correctly.

For more details, please see [www.bakerhughes.com/druck/global-service-support](http://www.bakerhughes.com/druck/global-service-support).

### 6.3 Visual Inspection

To make sure of continued safe operation examine the instrument before use: check for signs of damage (For example: cracks in the body, pressure connector damage or pressure leakage).

### 6.4 Clean the Unit

Clean the device body with a moist, lint-free cloth and a mild detergent. Do not use solvents or abrasive materials.



**CAUTION** To prevent damage to the instrument, do not let dirt get into the pressure mechanism.

### 6.5 Leak Test

Table 9-2 gives the maximum leak rates for each type of PV624 pressure station.

#### 6.5.1 Preparation

To do a leak test, use these items:

- a DPI620G calibrator
- the applicable PM620/PM620T module for the pressure station:
- P/N IPM620-13G (20 bar)
- an applicable blanking adaptor to seal the test port connection.

#### 6.5.2 Procedure

1. Seal the test port connection with the blanking plug.
2. Attach the applicable PM620/PM 620T module
3. Connect a DPI620G calibrator and energize the device (push the Power button).
4. Do a leak test for maximum pressure or maximum vacuum.

##### **Maximum pressure test**

1. Use the applicable procedure for the pressure station to set the maximum pressure - refer to Chapter 3 on page 11. Set the pressure to 20 bar.
2. Set the DPI620G calibrator to do a Leak Test: refer to Section 4.4.3 on page 26

**Channel Settings:** *Units = Bar, Utility = Leak Test*

**Settings:** *Test Time = 00:01:00 (1 minute)*

3. Let the pressure stabilize for 1 minute.
4. Start the test. When the test ends, compare the result with the specified leak rate; refer to Table 9-2.

##### **Maximum vacuum test**

1. Use the applicable procedure for the pressure station to set the maximum vacuum, - refer to Chapter 3 on page 11. Set the pressure to -900 mbar.
2. Set the DPI620G calibrator to do a Leak Test: refer to Section 4.4.3 on page 26.

**Channel Settings:** *Units = Bar, Utility = Leak Test*

**Settings:** *Test Time = 00:01:00 (1 minute)*

3. Let the pressure stabilize for 1 minute.
4. Start the test. When the test ends, compare the result with the specified leak rate; see Table 9-2.

## 6.6 Replacement of Battery



To remove and replace the battery:

1. Use a screwdriver to loosen the two screws until you release the battery cover.
2. Pull on the two screws to remove the cover, then pull the battery out.
3. When you insert the battery make sure its electrical connections point inwards.
4. Put the battery cover in position. Use a screwdriver to tighten the two screws to set the cover.



**INFORMATION** The battery must be left in the device for 24 hours to get maximum accuracy of all measurements. The device does not have to be energized (power on) during this period.

## 6.7 Spares

For advice or technical support for spare parts, please contact:

[drucktechsupport@BakerHughes.com](mailto:drucktechsupport@BakerHughes.com)

## 6.8 Instrument Return

### 6.8.1 Returned Goods Procedure

If the unit has to be calibrated or is not serviceable, please send it to the nearest Druck Service Centre given at: <https://www.bakerhughes.com/druck>

Contact the Service Centre to get a Return Goods Authorization (RGA). If you are in the USA, get a Return Material Authorization (RMA). Give this information on either a RGA or RMA:

- Product code
- Serial number
- Details of defect/work to be done
- Error code(s) if applicable
- Conditions of operation.

### 6.8.2 Instrument Disposal

Do not discard this product as household waste. Refer to Recycling Passport 174M0195 for the product. This can be downloaded from the product web page: <https://www.Druck.com/expert>.

Use an approved organization that collects and/or recycles unwanted electrical and electronic equipment.

For more information contact either our Customer Service Department (<https://www.bakerhughes.com/druck>) or your local government office.

## 6.9 Firmware Upgrade

Refer to End User Software Release Note (EUSR) for the full procedure to upgrade firmware in the PV624.

# 7. Test Procedures

## 7.1 Overview

This chapter gives examples of how to complete a documented calibration of Device Under Test (DUT) equipment or of assets using specified test procedures.

When you use test procedures to calibrate DUTs, the test details and results of the calibration are saved in DPI620G memory. This data can also be transferred to a PC for more analysis or post-calibration tasks.



## 7.2 Downloaded Procedures

Use the '**DOWNLOADED PROCEDURES**' option to complete a calibration that have been downloaded from the 4Sight2™ software. The 4Sight2™ calibration procedure has all the values necessary to calibrate a device under test (For example: test points, ramp time).

Select the Test Procedure icon on the Dashboard to access the 'Downloaded Procedures' function.

Refer to the user manual - K0541 for how to upload and download files by the use of the 4sight2 application.

## 7.3 Calibration Wizard

Use this function to make, save, and operate the test procedures. Use the test procedures for one test or multiple times for different devices under test. Test procedures can be created and stored for future use.

Refer to the user manual - K0541 for more information.

## 8. Error Messages

An error message is information displayed to the user when an unexpected condition occurs. Error message indicates that an action cannot be completed because of a system error. Error messages are used when user intervention is necessary, to show that a necessary operation did not operate correctly.

### 8.1 PV624 Error Codes

The following table gives descriptions of different error codes and messages and remedial actions which the user gets from the DPI620G display.

**Table 8-1: General error codes**

Code	Type	Message	Corrective/Recommended Action
0	Low Reference Sensor Voltage	Base Warning - Poor communications to PM. Ensure contact ring and pins are clean and dry	Poor communications to PM. Ensure contact ring and pins are clean and dry. Try connection of alternative sensor. If not recoverable, please contact service center.
2	Barometer Sensor Fail	Base Error - Barometer Sensor Failed. Manually vent the system and check the barometer connection to atmosphere is not blocked	Manually vent the system using the manual outlet. Check barometer connection to atmosphere not blocked. If not recoverable, please contact service center.
3	Stepper Controller Fail	Base Error - Controller failed. Power off, manually vent system & power on	Switch off unit, manually vent system and switch unit on, if this persists, please contact service center.
4	Low Motor Voltage	Base Error - Motor failed. Power off, manually vent system & power on	Switch off unit, manually vent system and switch unit on, if this persists, please contact service center.
5	Over pressure	Base Error - Over pressured. Vent system automatically or with manual vent	Vent system automatically or with manual vent.
6	Low Valve Voltage	Base error - low valve voltage	Not Recoverable. Please contact service center.
7	Persistent Memory Fail	Base error - memory failure	Not Recoverable. Please contact service center.
8	Low Battery Warning	Base Warning - Low battery - System will vent shortly. Please charge the PV624	Charge Base.
9	Critical Battery Warning	Base Error - Critical battery - System Venting and Disconnecting. Please charge the PV624	Charge Base.
13	Over Temperature	Base Error - Over temperature - Switch off the base and allow it to cool	DPI620G will disconnect from PV624 to prevent further operations. Switch off base and allow it to cool.

## Chapter 8. Error Messages

**Table 8-1: General error codes**

Code	Type	Message	Corrective/Recommended Action
14	Optical Board Not Found	Base error – optical sensor failed	Not Recoverable. Please contact service center.
17	Battery Communication Failure	Base Error - Battery Communication failed. Check Battery is connected	Check Battery is connected correctly. If issue persists, contact service center.
18	Battery Charger Communication Failure	Base error - battery charger communication failure	Not Recoverable. Please contact service center. The device battery cannot be charged. DPI620G will not be able to indicate battery charging state.
20	OS Error	Base error - OS error	Not Recoverable. Please contact service center.
23	Due for Service	Base Warning - PV624 is Due for Service	Service is recommended but this warning does not stop device operation. “Due for Service” message is shown when distance traveled is 960 m (which is equivalent to 5000 pressure cycles.) It is recommended to service the device before 1000 m. The “Barometer due for Calibration” message. The display will show this message if calibration is due in less than 30 days of the next set PV624 calibration.

## 9. Specification

### 9.1 PV624 Model

Refer to the below table 9-1 for a general specification of the PV624 pressure station.

**Table 9-1: General specification**

Operating temperature	0 to 50°C (32 to 122°F)
Storage temperature	-20 to 70°C (-4 to 158°F)
Ingress protection	IP54
Humidity	Up to 95% non-condensing
Shock/Vibration	As per MIL-PRF-28800F (Class II equipment)
Altitude	Up to 3000m
EMC	Electromagnetic compatibility: CE and UKCA approved IEC61326-1
Electrical safety	Electrical - CE and UKCA approved IEC61010
Pressure safety	CE and UKCA approved Sound Engineering Practice
Approvals	CE Marked, UKCA marked
Size (L: W: H)	(L) 343mm/13.5" x (W) 192mm/7.6" x (H) 136mm/5.4
Weight	PV624 only: ≈ 3.4kg/7.5lb
Pressure connections	Quick fit with G1/8 female + 1/8 NPT female adapter
Power supply	15V, 2A (30W)
Battery life (from 100% charge)	Minimum of 8 hours continuous use (typical)
Battery charge time	8 hours
Battery storage temperature Max. Recommended	-20 to 50°C (-4 to 122°F) -20 to 25°C (-4 to 77°F)
Service	>5000 pressure cycles
Power failure protection	System lock and manual vent valve feature provided
Connectivity	USB client micro-USB (+Bluetooth low energy for B1 option)
Barometer calibration port	G1/8
Test volume materials	Stainless Steel (316 & 306), Zinc plated mild steel, Nitrile rubber, Aluminium BS6082 T6, PVDF plastic, PEEK plastic, FPM rubber, FFPM perfluoro ether rubber, EPDM rubber, PTFE plastic, Polyurethane rubber

## Chapter 9. Specification

---

### 9.1.1 Pressure Data (PV624)

**Table 9-2: Pressure specification**

	PV624
Hybrid pressure generation range	-0.9 barg to 20 barg
Hybrid pressure generation compatible PM620 (FS) pressure ranges	0.7 barg(10 psig), 1 barg(15psig), 2 barg/abs(30 psig/abs), 3.5 barg/abs(50 psig/abs), 7 barg/abs(100 psig/abs), 10 barg/abs(150 psi), 20 barg/abs(300 psig/abs).
Maximum over range pressure (without damage)	20% of FS pressure
Barometer pressure measurement range	800-1100 mbar abs
Barometer total uncertainty (24hr)	<0.5 mbar
Barometer drift/year	<0.33 mbar/yr typical
Pressure control stability	50 ppm of PM620FS
0 barg to 2barg +/-50ppm into 15ml volume	<15 sec
0 barg to 20barg +/-50ppm into 50ml volume	<90 sec
Maximum leak rate at 20barg with 50ml volume	60 mbar/min



## 9.2 PM620/PM620T Module

Refer to the table 9-3 for general specification of the PM620/PM620T module.

**Table 9-3: General specification**

Operating temperature	-10 to 50°C (14 to 122°F) Calibrated range: 0 to 50°C (32 to 122°F)
Storage temperature	-20 to 70°C (-4 to 158°F)
Ingress Protection	IP54
Humidity 0 to 30°C (32 to 86°F): 30 to 50°C (86 to 122°F):	Relative humidity (RH) 0 to 95% RH non-condensing 0 to 60% RH non-condensing
Shock/Vibration	Def Stan 66-31, 8.4 cat III
EMC	Electromagnetic compatibility: BS EN 61326-1
Electrical safety	Electrical - BS EN 61010-1
Pressure safety	Pressure Equipment Directive - Class: Sound Engineering Practice (SEP)
Approved	CE Marked
Size	Length, Diameter ≈ 58 x 44 (2.3 x 1.7 in)
Weight	Maximum: ≈ 0.11 kg (0.2 lb)
Pressure connections	Positive (male) port: Attaches to PV624 pressure station only M5 (female) reference pressure port.

### 9.2.1 Pressure Data (PM620/PM620T modules)

**Table 9-4: Maximum working pressure**

Ranges:	MWP
≤ 350 mbar (5 psi)	2 x FS
> 350 mbar (5 psi)	1.2 x FS

# Appendix A. COMPLIANCE STATEMENTS

## A.1 FCC (USA)

### Federal Communication Commission Interference Statement

This equipment has been tested and found to comply with the limits for a Class B digital device, pursuant to Part 15 of the FCC Rules. These limits are designed to provide reasonable protection against harmful interference in a residential installation. This equipment generates, uses, and can radiate radio frequency energy and, if not installed and used in accordance with the instructions, may cause harmful interference to radio communications.

However, there is no guarantee that interference will not occur in an installation. If this equipment does cause harmful interference to radio or television reception, which can be determined by turning the equipment off and on, the user is encouraged to try to correct the interference by one of the following measures:

- Reorient or relocate the receiving antenna.
- Increase the separation between the equipment and receiver.
- Connect the equipment into an outlet on a circuit different from that to which the receiver is connected.
- Connect the equipment into an outlet on a circuit different from that to which the receiver is connected.

**FCC Caution:** Any changes or modifications not expressly approved by the party responsible for compliance could void the user's authority to operate this equipment.

This device complies with Part 15 of the FCC Rules. Operation is subject to the following two conditions:

1. This device may not cause harmful interference; and,
2. This device must accept any interference received, including interference that may cause undesired operation.

### FCC Radiation Exposure Statement

This product complies with the US portable RF exposure limit set forth for an uncontrolled environment and is safe for intended operation as described in this manual. Further RF exposure reduction can be achieved if the product is kept as far as possible from the user body or is set to a lower output power if such function is available.

This transmitter must not be co-located or operated in conjunction with any other antenna or transmitter.

## A.2 CANADA

### ISED Canada Statement

This device complies with Industry Canada's license-exempt RSSs. Operation is subject to the following two conditions:

1. This device may not cause interference; and
2. This device must accept any interference, including interference that may cause undesired operation of the device.

Le présent appareil est conforme aux CNR d'Industrie Canada applicables aux appareils radio exempts de licence. L'exploitation est autorisée aux deux conditions suivantes:

1. l'appareil ne doit pas produire de brouillage;
2. l'utilisateur de l'appareil doit accepter tout brouillage radioélectrique subi, même si le brouillage est susceptible d'en compromettre le fonctionnement.

### Radiation Exposure Statement

The product complies with the Canada portable RF exposure limit set forth for an uncontrolled environment and are safe for intended operation as described in this manual. The minimum separation distance for portable use is limited to 15mm assuming use of antenna with 2 dBi of gain. The further RF exposure reduction can be achieved if the product can be kept as far as possible from the user body or set the device to lower output power if such function is available.

### Déclaration d'exposition aux radiations

Le produit est conforme aux limites d'exposition pour les appareils portables RF pour les Etats-Unis et le Canada établies pour un environnement non contrôlé. La distance de séparation minimale pour l'utilisation portative est limitée à 15mm en supposant l'utilisation de l'antenne avec 2 dBi de gain. Le produit est sûr pour un fonctionnement tel que décrit dans ce manuel. La réduction aux expositions RF peut être augmentée si l'appareil peut être conservé aussi loin que possible du corps de l'utilisateur ou que le dispositif est réglé sur la puissance de sortie la plus faible si une telle fonction est disponible.

## Office Locations



## Services and Support Locations

