



Aurora TransPort

User's manual

910-325 Rev. A

Aurora TransPort

Moisture analyzer for natural gas

User's manual

910-325 Rev. A
June 2018



[no content intended for this page]

Contents

Product registration	ix
Services	ix
Typographical conventions	ix
Safety issues	ix
Auxiliary equipment	ix
Environmental compliance	x
Chapter 1. Features and capabilities	1
1.1 Overview	1
1.2 important use limitations	1
1.3 Features	1
1.4 TD LAS – Theory of operation	2
1.5 Sample system components	3
1.6 TDLAS measurement specifications	4
1.7 Sample system specifications	4
1.8 Power, display, and I/O specification	4
Chapter 2. Installation	5
2.1 Introduction	5
2.2 Bill of materials	5
2.3 Unpacking	5
2.4 Choosing a site for installation	5
2.5 Making electrical connections	5
2.6 Charging the battery	6
2.7 Exchanging the battery	6
2.8 Monitoring battery status	6
2.9 Specific conditions of use	6
Chapter 3. Operation and general programming	7
3.1 Using the Aurora TransPort	7
3.2 Sample system	7
3.2.1 Aurora TransPort startup	7
3.2.2 Aurora TransPort shut down	8
3.3 Keypad Features	9
3.3.1 Indicator lights	9
3.3.2 The default display	9
3.3.3 Unlocking the keypad	10
3.3.4 Accessing the menus	10
3.3.5 Entering numeric values	10
3.3.6 Starting up	10

3.4	Setting up the Display	11
3.4.1	Selecting primary units	11
3.4.2	Selecting Alt 1 and Alt 2 units	11
3.4.3	Setting decimal places	11
3.4.4	Data/Scan	12
3.4.5	Adjust	12
3.4.6	Reverse	12
3.5	Setting up the outputs	12
3.5.1	Selecting an output for setup	12
3.5.2	Selecting output units	13
3.5.3	Selecting an output type	13
3.5.4	Changing the upper output span	14
3.5.5	Changing the lower output span	14
3.5.6	NAMUR Response	15
3.5.7	NAMUR Filtering	16
3.5.8	Testing the output	17
3.5.9	Trimming the outputs	17
3.6	Setting up the alarms	18
3.6.1	Selecting an alarm output	18
3.6.2	Selecting alarm status	18
3.6.3	Selecting alarm units	19
3.6.4	Selecting an alarm type	19
3.6.5	How the alarm types work	20
3.6.6	Changing the upper alarm span	20
3.6.7	Changing the lower alarm span	20
Chapter 4	Programming advanced features	21
4.1	Comm port settings	21
4.1.1	Selecting a Comm port	21
4.1.2	Setting the Baud rate	21
4.1.3	Setting the parity	21
4.1.4	Selecting the protocol	22
4.1.5	Setting the network ID	22
4.1.6	Adjusting the response delay	22
4.1.7	Serial port test	23
4.2	Ethernet settings	24
4.2.1	Connection to the Internet/WAN	24
4.2.2	Default passwords	24
4.2.3	Connecting to an Ethernet LAN	24
4.2.4	IP address assignment	25
4.2.5	Device discovery	25
4.3	Adjust offset values	26
4.3.1	Adjusting the PPMv offset	26
4.3.2	Adjusting the smoothing filter	26
4.3.3	Adjusting the scan averaging	26
4.3.4	Setting the dew point calculation method	27
4.3.5	Saturation calculation	27

4.4	Set up the background gas	28
4.4.1	Selecting the type of gas	28
4.4.2	Setting the Z factor	28
4.4.3	Entering a label	29
4.4.4	Adjusting the gas molecular weight	29
4.5	Clock settings	30
4.5.1	Setting the hour	30
4.5.2	Setting the minutes	30
4.5.3	Setting the month	30
4.5.4	Setting the date	30
4.5.5	Setting the year	31
4.6	Pressure settings	31
4.6.1	Setting pressure units	31
4.6.2	Setting the source	31
4.6.3	Changing the constant	32
4.7	Regional settings	32
4.7.1	Setting the country code	32
4.7.2	Setting the decimal format	32
4.7.3	Setting the date format	33
4.7.4	Setting the unit system	33
4.8	User calibration	33
4.9	Service settings	35
4.10	Aurora TransPort information	35
4.10.1	Checking the ID	35
4.10.2	Checking the system status	36
4.10.3	Checking the software	36
4.10.4	Checking the gas composition	36
4.10.5	Checking the alternate gas composition	37
4.11	Locking/Unlocking the display	37
Chapter 5	AuroraView interface software	42
5.1	Capabilities	42
5.2	Requirements	42
5.3	Installing AuroraView	42
5.4	Starting AuroraView	44
5.5	Using the main menus	45
5.6	Datalogging with AuroraView	48
5.7	Working with trend plots, trend tabular data and scan plots	49
Chapter 6	Maintenance	53
6.1	Spare parts	53
6.2	Cleaning the mirror	53
6.3	Replacing the filter element	58

- Chapter 7. TransPort troubleshooting60**
 - 7.1 Introduction60
 - 7.2 Blank display60
 - 7.3 Display dim or hard to read60
 - 7.4 Status messages and indicators60
 - 7.5 No flow measurement indicated on Aurora TransPort measurement cell outlet. 61

- Appendix A. TransPort MODBUS RTU/TCP communications 63**
 - A.1 Introduction 63
 - A.2 Mod bus functions and data types 63
 - A.3 Modbus registers 64
 - A.4 Modbus system status codes 68

- Appendix B. Aurora TransPort Ethernet operation..... 69**
 - B.1 Introduction 69**
 - B.1.1 Connection to the Internet/WAN 69
 - B.1.2 Default passwords 69
 - B.1.3 Open ports and services warning. 69
 - B.1.4 Initial setup. 69
 - B.2 Device discovery..... 70**
 - B.3 User accounts 70**
 - B.3.1 The root account. 70
 - B.3.2 The operator account. 71
 - B.4 Communicating by MODBUS via Ethernet71**
 - B.4.1 MODBUS/TCP..... 71
 - B.4.2 MODBUS/RTU72
 - B.5 Using TELNET for configuration 72**
 - B.6 Using the MS Windows Telnet client 72**

Product registration

Thank you for purchasing a model Aurora TransPort from Panametrics. Please register your product at <http://info.geoilandgas.com/productRegistration.html> for product support such as the latest software/firmware upgrades, product information and special promotions.

Services

Panametrics provides customers with an experienced staff of customer support personnel ready to respond to technical inquiries, as well as other remote and on-site support needs. To complement our broad portfolio of industry-leading solutions, we offer several types of flexible and scalable support services including: Training, Product Repairs, Service Agreements and more. Please visit <http://www.gemeasurement.com/services> for more details.

Typographical conventions

Note: These paragraphs provide information that provides a deeper understanding of the situation, but is not essential to the proper completion of the instructions.

IMPORTANT:

These paragraphs provide information that emphasizes instructions that are essential to proper setup of the equipment. Failure to follow these instructions carefully may cause unreliable performance.



CAUTION!

This symbol indicates a risk of potential minor personal injury and/or severe damage to the equipment, unless these instructions are followed carefully.



WARNING!

This symbol indicates a risk of potential serious personal injury, unless these instructions are followed carefully.

Safety issues



WARNING!

It is the responsibility of the user to make sure all local, county, state and national codes, regulations, rules and laws related to safety and safe operating conditions are met for each installation.



Attention European customers!

To meet CE Mark requirements for all units intended for use in the EU, all electrical cables must be installed as described in this manual.

Auxiliary equipment

Local safety standards

The user must make sure that he operates all auxiliary equipment in accordance with local codes, standards, regulations, or laws applicable to safety.

Working area



WARNING!

Auxiliary equipment may have both manual and automatic modes of operation. As equipment can move suddenly and without warning, do not enter the work cell of this equipment during automatic operation, and do not enter the work envelope of this equipment during manual operation. If you do, serious injury can result.



WARNING!

Make sure that power to the auxiliary equipment is turned OFF and locked out before you perform maintenance procedures on this equipment.

Qualification of personnel

Make sure that all personnel have manufacturer-approved training applicable to the auxiliary equipment.

Personal safety equipment

Make sure that operators and maintenance personnel have all safety equipment applicable to the auxiliary equipment. Examples include safety glasses, protective headgear, safety shoes, etc.

Unauthorized operation

Make sure that unauthorized personnel cannot gain access to the operation of the equipment.

Environmental compliance

RoHS

The Aurora TransPort fully complies with RoHS regulations.

Waste Electrical and Electronic Equipment (WEEE) directive

Panametrics is an active participant in Europe's Waste Electrical and Electronic Equipment (WEEE) take-back initiative, directive 2012/19/EU.



The equipment that you bought has required the extraction and use of natural resources for its production. It may contain hazardous substances that could impact health and the environment.

In order to avoid the dissemination of those substances in our environment and to diminish the pressure on the natural resources, we encourage you to use the appropriate take-back systems. Those systems will reuse or recycle most of the materials of your end life equipment in a sound way.

The crossed-out wheeled bin symbol invites you to use those systems.

If you need more information on the collection, reuse and recycling systems, please contact your local or regional waste administration.

Visit <https://www.bakerhughesds.com/health-safety-and-environment-hse> for take-back instructions and more information about this initiative.

Chapter 1. Features and capabilities

1.1 Overview

Panametrics' **Aurora TransPort** moisture analyzer makes it possible for natural gas processing and transportation facilities to spot check moisture content in real-time with high precision and reliability.

The analyzer system is designed to continuously monitor moisture content in an extracted sample of process gas using tunable diode laser absorption spectroscopy (TDLAS). It fundamentally measures the partial pressure of water vapor (water in the gas state), and with the simultaneous measurement of pressure and temperature, provides readings and both analog and digital signal transmission of user-selectable moisture parameters including dew point temperature, volume ratio and absolute humidity (lbs/MMSCF or mg/m³) in addition to temperature and pressure.

Its light weight (<50 lbs) and compact rugged design make it ideal for rapid deployment and use. The self-contained sample system allows for quick and easy gas connections and achieving stable readings within a few minutes of starting gas flow.

Analysis of the extracted sample uses TDLAS to determine moisture content in the gas with high accuracy and repeatability down to ppmV levels. Its fast response quickly alerts the user when moisture concentrations are out of compliance. Once upsets are corrected and the process recovers, the fast response enables gas flow to be quickly cleared for entry into the "energy grid".

Sample inlet gas conditioning is provided by an integrated sampling system comprised of pressure relief valve, isolation and flow control valves, liquid-block membrane filter, and flow indicator.

1.2 Important use limitations

Environmental conditions

With the **Aurora TransPort** case open, the analyzer is not designed to prevent dust or water ingress. The operator must be aware of weather conditions and coffee cup placement to prevent instrument damage or possible injury.



CAUTION!

Liquids spilled onto the analyzer top panel may leak into the electronics enclosure causing severe damage to laser control and measurement circuitry, or possible user injury.

With the **Aurora TransPort** case closed and fully latched, the analyzer is protected from dirt and water ingress with a rating of IP 66.

Orientation

When moving **Aurora TransPort**, all 4 cover latches should

always be secure and snapped into their latched positions. During operation or when the case is open or unlatched, **Aurora TransPort** should be positioned on a flat surface with the top panel facing upward and at an angle no greater than 45° from horizontal.



CAUTION!

Liquids spilled onto the analyzer top panel may leak into the electronics enclosure causing severe damage to laser control and measurement circuitry, or possible user injury.

1.3 Features

Rugged, light weight design [<50lbs] with telescoping handle with large inline wheels for easy deployment across flat surfaces. Also provided are 3 heavy duty lift handles for loading and unloading into motor vehicles.

- Operates for a minimum of 8 hours on a single battery charge.
- Optical response: < 2 seconds after flow cell is purged
- No cross sensitivity to glycols or amines
- Direct readout in ppmV, dew/frost point (°C, °F), density (lbs/mmscf, mg/m³) or vapor pressure (kPa, mmHg)
- Calculation and readout of process pressure dew point (with user programmable constant or remote Modbus input for process pressure)
- Integral sampling system specifically designed for natural gas applications ensures measurement integrity with NACE MR01 75 and ASME 3.1 material certifications available on request
- 4-20 mA signals, RS-232/485 MODBUS RTU for connection to SCADA or plant monitoring system, and Ethernet MODBUS/TCP
- Supplied with **AuroraView** software for remote configuration, data logging and data retrieval capacity
- Provides 3 standard NIST traceable calibrations in 100% nitrogen, 100% methane, and a 90% methane +10% nitrogen mixture
- In conformance with IEC 60825-1 Edition 2.0 Safety of Laser Products

1.4 TDLAS – Theory of operation

The fundamental water vapor pressure measurement is based on the *Beer-Lambert Law*:

$$A = \ln\left(\frac{I_0}{I}\right) = SLN$$

where:

- A = Absorbance
- I = Light intensity transmitted through a sample gas
- I_0 = Incident light intensity
- S = Absorption coefficient*
- L = Absorption path length (a constant)
- N = Concentration of the water vapor in the absorption cell

* The absorption coefficient is a constant for a specific gas composition at a given pressure and temperature.

At certain specific frequencies/wavelengths of light, light energy will be absorbed by water molecules. As moisture level increases, absorption also increases. The analyzer sweeps the diode laser output across a narrow frequency band in the near infrared spectrum. By measuring returning beam intensity with a photodetector as a function of light frequency, Aurora TransPort is able to provide a direct indication of the gas water content.

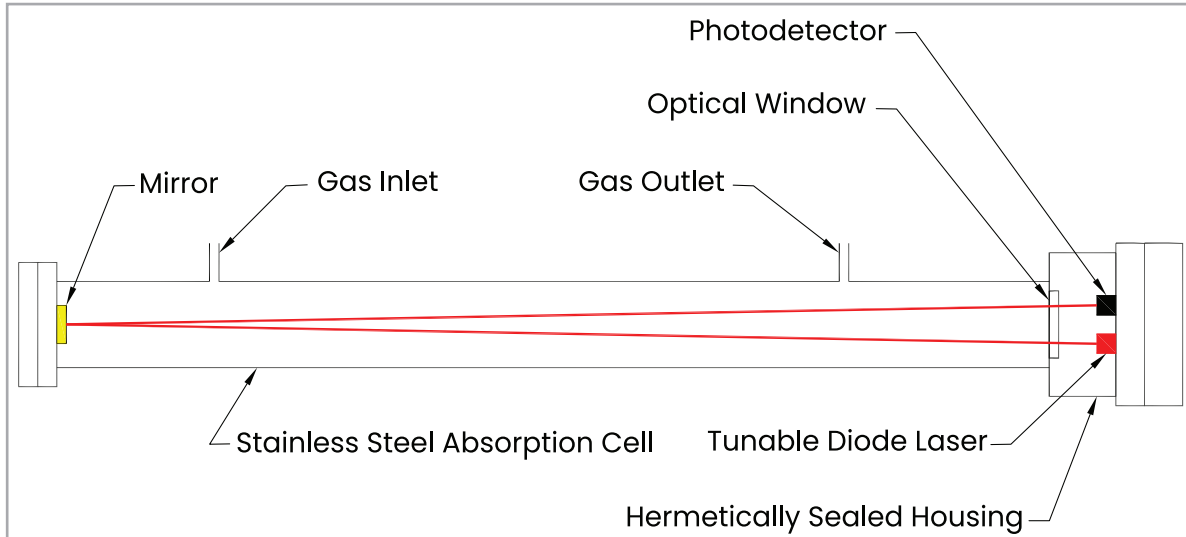

Figure 1: Laser absorption cell, basic elements

Aurora TransPort is capable of providing moisture measurements in a variety of units.

The partial pressure of water, multiplied by 10⁶ and divided by the total sample pressure, yields the volume ratio in ppmv (parts per million by volume).

The laser diode is housed in a hermetically sealed and dry housing. The light is transmitted through a window made of proprietary transparent material. The light travels through a stainless steel cell and is reflected off a gold-plated mirror and returned to a photo detector, where the light intensity is measured.

Since only light comes in contact with the sample of natural gas, and all of the wetted materials are made of non-corrosive and inert materials, this technology does not exhibit the drift associated with gas contacting sensor-based hygrometers.

The diode laser emits low energy light, and therefore, the system is incapable of igniting the gas. The **Aurora TransPort** provides an output measurement of the sampled gas with a rapid response time. Initial response can be observed in less than 2 seconds after the process gas enters the cell and reaching 95% of final equilibrium within about 10 minutes (@ 1 SLM flow rate).

The control of the laser, power supply and signal conditioning circuitry are housed in a rugged dust-proof vibration isolated transmitter enclosure. A backlit, three-parameter, LCD display provides digital indication of user-programmable parameters.

The **Aurora TransPort** has three user-programmable (4–20 mA) analog outputs and two programmable digital ports that may be configured as either RS-485 or RS-232 with Modbus protocol. Remote user-defined input of the process pressure enables the **Aurora TransPort** to display and transmit the process dew point. Aurora View software is provided and enables remote readings, programming data logging and data logging with a personal computer.

Aurora TransPort is calibrated against a NIST (or other national metrological institute) traceable reference dew point generator and hygrometer. Each system is supplied with a certificate of calibration and functional test data.

1.5 Sample system components

The **Aurora TransPort** sample system is a compact design providing the functionality for measurement of sample pressure, temperature, and flow conditions. Manual control valves are provided for adjusting sample and bypass flow rates, as well as analyzer isolation during transport.

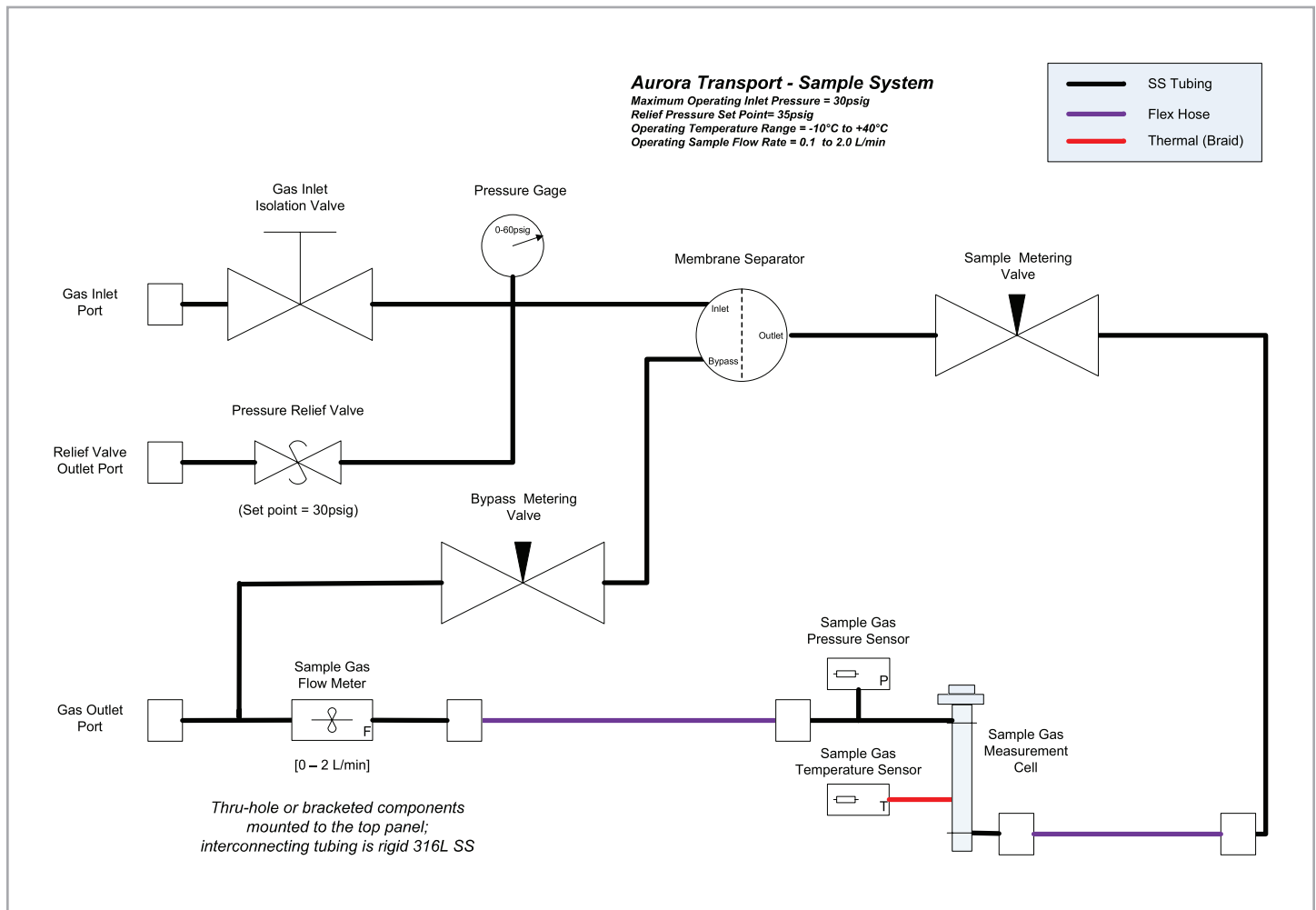

Figure 2: Aurora TransPort integral gas sample system schematic

A pressure relief valve, set to relieve at 30psig, is provided to prevent accidental over pressurization of the sample system, causing equipment damage or personnel injury.

The membrane separator (filter) is readily accessible from the top panel for cleaning or element replacement.

Typical analyzer sample flow rate is 1 SLM with digital readout on the keypad display.

1.6 TDLAS measurement specifications

Calibrated Range:	0 to 1000 ppmv
Calibrated Accuracy:	±2 ppm V or ± 1 % of reading, whichever is greater (NIST or equivalent NMI traceable certification)
Reading Repeatability:	±0.2 ppmv or ±0.1 %, whichever is greater (CO2 applications: ±1.0 ppmv or ±0.5%, whichever is greater)
Lower Detection Level:	2 ppmV (CO2 applications: 20 ppmV)
Optical Response Time:	< 2 seconds
Standard Calibration Gases:	100% N2, 100% CH4, and 90% CH4 + 10% N2 mixture
Optional Calibration Gases:	Up to 3 custom calibrations (pure gases or mixtures)
Operating Temperature Range:	-20°C to +50°C (14°F to 149°F)
Operating Sample Pressure Range:	10 psia to 25 psia (69kPa to 149kPa)

1.7 Sample system specifications

Maximum Inlet Pressure:	30psig
Sample Cell Flow Rate:	10 to 60 SLH (0.4 to 2.1 SCFH); 30 SLH (1 SCFH) nominal
Sample Bypass Flow Rate:	5X to 10X sample cell flow rate (typical)
Sample TransPort Time:	Dependent on the length of tubing between pipe line tap-off point to the analyzer inlet and total analyzer gas flow (sample + bypass)

1.8 Power, display, and I/O specification

Charger Input:	Universal AC Input (100-240 VAC, 50/60 Hz)
Battery Charge:	>8 hours of analyzer runtime on a single charge; 4.5 hours for fully discharged battery to be fully charged
Display:	Backlit LCD; three programmable simultaneous parameters; alphanumeric status and diagnostic display; LEDs for power, laser temperature stability and keypad lockout
Analog Outputs:	Three 0/4-20 mA DC (source) with 500 ohm load; user programmable and scalable for any parameter; complies with NAMUR protocol for analog signals
Digital Interfaces:	Two programmable digital communications ports: RS232, RS485 with multi-drop capability and assignable address; MODBUS RTU protocol
Ethernet I/O port:	One Modbus TCP/IP protocol

Chapter 2. Installation

2.1 Introduction

The **Aurora TransPort** analyzer provides direct indication of moisture concentration in natural gas as well as other applications in refineries, heat treating furnaces, etc. Temperature and pressure sensors are used to provide high precision enhancement. It is designed to operate safe areas only as it does not have any hazardous area certification.

Be sure that the ambient temperature is at least 10°C higher than the maximum dew/frost point temperature you expect to measure. This will ensure that you will not have liquid condensation in the sample transport line or the **Aurora** sampling system components.

2.2 Bill of materials

The following items should have been received with your shipment:

- Aurora TransPort Unit in Pelican transport case
- Aurora TransPort Calibration Data Sheet
- Aurora TransPort User's Manual on USB flash drive
- Maintenance/Accessories Kit
- Aurora View Software on USB flash drive
- AC/DC power supply (24 VDC output) with appropriate AC power cord.

2.3 Unpacking

The **Aurora TransPort** is shipped in a packing box. Open the box from the top, and remove the foam packing material.

The **Aurora TransPort** weighs approximately 50 pounds (23 kgs). It has three handles for lifting. Each handle is capable of supporting the entire weight of the analyzer. Remove the analyzer from the packing box.

Check all the received components and record the model numbers and serial numbers for your records. If anything is missing, please contact Panametrics immediately.

2.4 Choosing a site for installation

You should have discussed environmental and installation factors with a Panametrics Sales, Application or Service Engineer by the time you receive the analyzer.

Before installing the analyzer, read the guidelines below on installation recommendations:

1. Choose an installation site for the **Aurora TransPort** analyzer as close to the actual sample point (sample take-off point) as possible, to minimize transport time to the analyzer.

2. Avoid unnecessarily long lengths of sample transport tubing to minimize transport time to the analyzer.
3. Avoid dead-legs in the sample transport tubing to minimize the possibility of liquid condensate build-up.
4. Use stainless steel tubing. Avoid using copper tubing, as the water molecule has greater adsorption capabilities for copper compared to stainless steel. Avoid rubber or plastic tubing at all costs, as water molecules will interact with the tubing, and ambient moisture can permeate through the tube wall into the sample gas.
5. Place the TransPort Pelican case on a horizontal surface before opening it.
6. Be sure that the ambient temperature is at least 10°C higher than the maximum dew/frost point temperature you expect to measure. This will ensure that you will not have liquid condensation in the sample transport line nor in the Aurora TransPort. Heat tracing the sample line will aid in elevating the sample temperature above the dew point. An optional heater installed within the enclosure is also available.

2.5 Making electrical connections

1. The **Aurora TransPort** has remote data logging capability using Aurora View software by one of two serial communication modes.



Figure 3: Aurora TransPort I/O cable connections

Ethernet Mode (Recommended):

Only one connection port and one top-panel jack is provided and labeled "Ethernet". It is the simplest serial communications connection to make and will meet the needs of most users. Connect to the analyzer using a shielded CAT5e Ethernet cable with the TIA/EIA-568 specification.

RS-232/RS-485 Mode:

There are two connections ports provided. Port 1 is designated as "SCADA.A" and Port 2 is designated as "SERVICE". Both ports are accessed via the top-panel connector labeled "Analog+Digital Outputs".

For connection use the **Aurora TransPort** remote accessory cable (BHGE# 130M5430). This cable is not supplied with the analyzer. It must be purchased separately (see "Aurora TransPort Spare Parts List" on page 53 of this manual).

The as-shipped default communication settings for both ports are as follows:

BAUD Rate:	115,200
Parity:	Even
Network ID:	1 for Port 1, 2 for Port 2

- The Aurora TransPort has three channels of programmable analog (4-20mA) measurement output capability. Each channel can be assigned to any measurement parameter and precisely scaled to the users input range requirements. For connection use the Aurora TransPort remote accessory cable (BHGE# 130M5430). This cable is not supplied with the analyzer. It must be purchased separately (see "Aurora TransPort Spare Parts List" on page 53 of this manual).

2.6 Charging the battery

The Aurora TransPort is powered by a rechargeable lithium ion (Li-ion) battery. Under normal use, the battery will provide more than 10 hours of continuous operation before a recharge is required. The Aurora TransPort contains a battery monitoring and charging circuit to rapidly and safely recharge the battery.

A universal input AC-DC converter is supplied to power the internal charger. Plug the converter into a suitable AC voltage source, then plug the barrel connector into the Aurora 24 VDC charging jack. With the Aurora switched OFF, the battery can be completely recharged in approximately 3 hours. Charging time may be longer at low or high temperature extremes.

The Aurora has two charge status LEDs located adjacent to the power connector. The **red** LED adjacent to the line power symbol (⚡) will illuminate when the converter is supplying DC voltage.

The **green** LED adjacent to the battery symbol (🔋) will flash once per second while the battery is charging. When the battery is fully charged, the LED will stay solid green.

To prolong the useful life of the battery, the converter should be unplugged when the battery is fully charged.

2.7 Exchanging the battery

When operating for very long duration, or when suitable AC power is not available, an optional spare battery can be quickly swapped in to continue operating.



- Switch the Aurora TransPort OFF.
- Unplug the AC charger from the Aurora, if present.
- Loosen, but do not remove, the two Phillips screws holding the battery retainer tab.
- Slide the battery retainer to the left.
- Pull the battery out by lifting the cloth loop attached to the left end of the battery.
- Insert the spare battery from the right end first, then press the left end down so that the battery is firmly seated.
- Slide the battery retainer to the right.
- Hand tighten the two Phillips screws of the battery retainer.
- Switch the Aurora TransPort ON.

Note: An optional desktop battery charger (BHGE# 130M6684) is available to recharge spare batteries when the Aurora TransPort is not available.

2.8 Monitoring battery status

The Aurora TransPort continuously monitors the state of charge of the battery. A battery charge indicator is provided in the upper left of the data display:



- A solid filled indicator  represents a full charge
- A partially filled indicator  displays as the battery discharges
- A hollow indicator  represents less than 5% charge remaining.

Note: If the charger is plugged in while the Aurora TransPort is operating, the indicator will change continuously to represent the charging state.

2.9 Specific conditions of use

Before operating your Aurora system, be sure the following conditions are met:

Operating on flat surface and preventing any liquids to come in contact with the unit during operation.

Chapter 3. Operation and general programming

3.1 Using the Aurora TransPort

Follow the information in this chapter to operate the Aurora TransPort system.

CLASS 1 LASER PRODUCT



WARNING!

Use of controls or adjustments or performance of procedures other than those specified herein may result in hazardous laser exposure.

3.2 Sample system

Refer to Figure 4 below to locate components referenced in the startup guide.

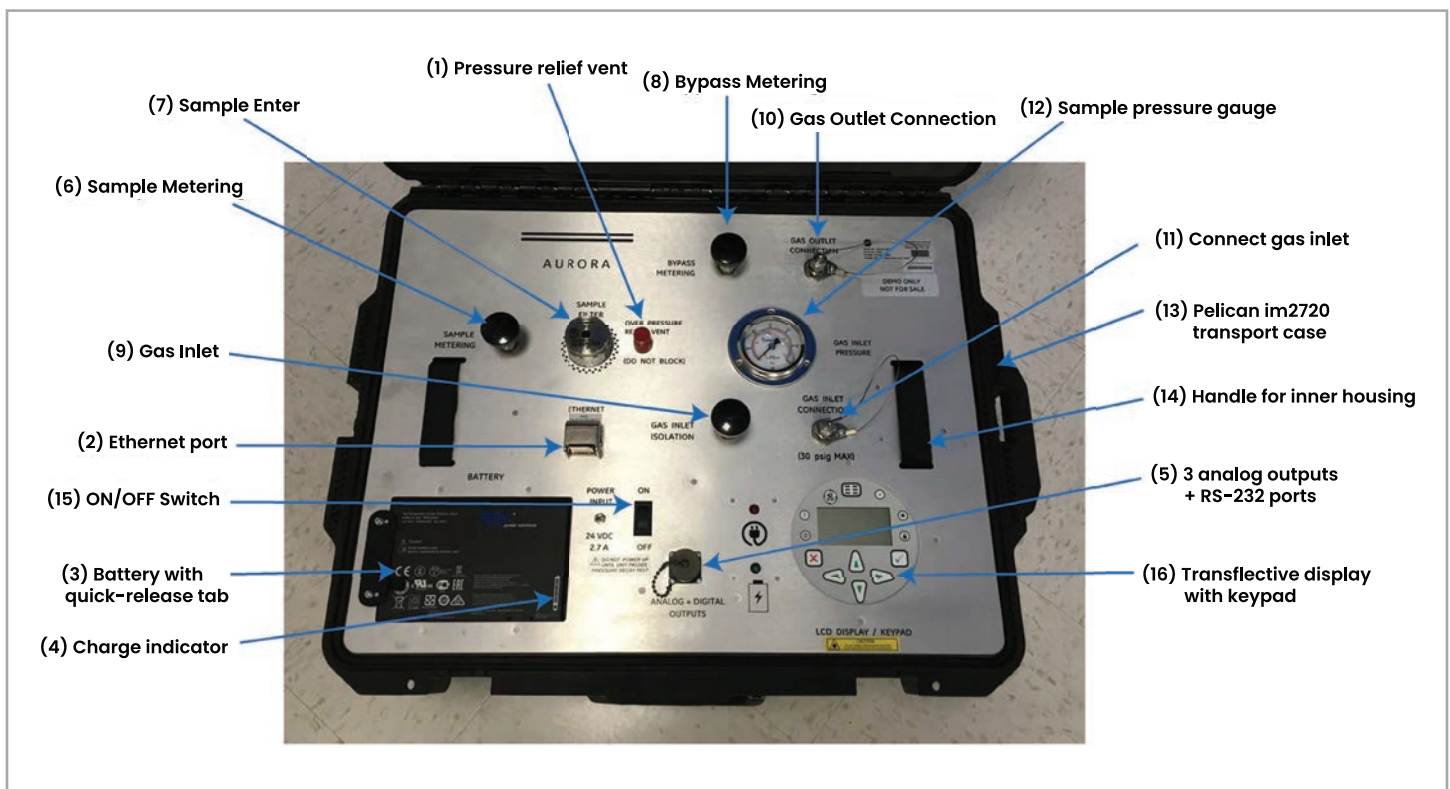

Figure 4: Front panel of BHGE Aurora TransPort

3.2.1 Aurora TransPort startup

1. Ensure the Pelican transport case (13) is lying flat and horizontal on a stable surface before opening the cover.
2. Install the Li-ion battery shipped with the unit into battery slot after loosening tab (3) on left with orientation as shown in Figure 4.
3. Fully charge the battery (3 hours max) using ONLY the external AC charger provided.



CAUTION!

Using other AC chargers may damage the battery.

4. Before powering up the unit, perform a coarse leak test of the sample system, preferably with clean, dry nitrogen/air supply. Please refer to Figure 2 for sample system schematic.
 - a. Ensure that gas inlet pressure is < 30 psig with gas inlet (9), sample metering (6), and bypass metering (8) valves fully shut.
 - b. Remove the protective cap and connect the gas sample line to the inlet gas port (11). Ensure the outlet gas port (10) is capped and tightened using a 9/16" open-end wrench.
 - c. Fully open the sample metering (6) and bypass metering (8) valves.
 - d. Slowly open the gas inlet valve (9), increasing inlet gas pressure to ~25 psig (or equal to gas sample inlet pressure if < 25 psig) as read on the inlet pressure gauge (12). Then fully close the gas inlet valve (9).
 - e. If there are no internal leaks, the gauge pressure reading should decay no more than 0.5 psig after 20 minutes.
 - f. Remove the protective cap from the gas outlet port (10) using a 9/16" open-end wrench and wait for the inlet pressure gauge (12) to return to 0 psig.
5. Fully close the sample metering valve (6) and ensure bypass metering valve (8) remains fully open.
6. Connect the gas vent line to the gas outlet port (10) using a 9/16" open-end wrench.

CAUTION!



Verify the gas pressure relief vent (1) is free and open for gas flow. If the vent outlet is blocked, the pressure relief valve cannot function and unit will be exposed to full inlet pressure. The gas outlet port should be connected to a hose, pipe or tubing with discharge point at least 6 feet from the unit.

7. Turn ON the front panel switch (15) and observe LCD display (16) light up.
8. Aurora Transport will boot up and go through 4-5 initialization steps that should take ~2 minutes. After LCD display shows a moisture reading with no warnings, allow 5 minutes for the unit to line-lock and report stable readings.
9. Ensure sample inlet gas pressure is < 30 psig and then fully open the gas inlet valve (9).
10. Slowly close the bypass metering valve (8) until the inlet pressure gauge (12) reads ~ 10 psig.
11. Slowly open the sample metering valve (6) and set ~ 1 SLM sample flow as read from the LCD display (16).
12. If desired, sample bypass flow may be further decreased using bypass metering valve (8). The sample metering valve (6) must be adjusted in tandem to keep sample gas flow at ~ 1 SLM.

CAUTION!



Operating with inadequate bypass flow may trip the membrane filter's liquid block feature, when natural gas liquids are present in the sample stream. If tripped, reset it by fully closing the supply gas isolation (9) and sample metering (6) valves, and fully opening the bypass metering valve (8). Then repeat the unit start-up from Step 9.

13. If fast-Loop operation is required, open and adjust the bypass metering valve (6) until the desired response (i.e., sample transport time) is achieved.

3.2.2 Aurora TransPort shut down

1. Power OFF the unit using front panel switch (15).
2. Fully close the supply gas isolation valve (9).
3. Fully close the bypass metering (8) and sample metering valves (6).
4. Disconnect gas sample and discharge tubing from gas inlet (11) and gas outlet (10) ports using 9/16" wrench.
5. Re-install the protective port fitting caps.

3.3 Keypad features



Figure 5: Aurora TransPort keypad

The **Aurora TransPort** has seven keys: a **Menu** key, four **Arrow** keys, a **Cancel** [x] key, and an **Enter** [✓] key.

1. Use the **Menu** key to open the main menu on the display.
2. Use the **Arrow** keys to navigate among menu choices and to increment/decrement numeric entries.
3. Use the **Cancel** [x] key to cancel a numeric entry change, or exit a menu.
4. Use the **Enter** [✓] key to accept a numeric entry or select a menu option

3.3.1 Indicator lights

If the **Fault Indicator** is lit, an instrument fault is detected. A message will be displayed in the Main Display, top/right.

If the **Information Indicator** is lit, the instrument is still operating, but a message will appear in the Main Display top/right, with information about the instrument.

The **Keypad Lock Indicator** will be lit if the instrument keypad has not been used for a period of several minutes, engaging a software feature to lock-out inadvertent key usage. Unlock the keypad by pressing **Cancel**, **Enter**, **Cancel** in sequence.

If the **Laser Indicator** is lit, the laser is powered and operating normally. This indicator will be off if there is a laser-specific fault. This indicator will also be off for a brief period when the instrument is first powered.

After initial power-up, this indicator may blink several times as the laser temperature is stabilized. The laser indicator will be lit constantly in normal operation.

The **Power Indicator** is normally lit when the instrument is powered on.

3.3.2 The default display

Figure 6 below shows the default display of the **Aurora TransPort**.

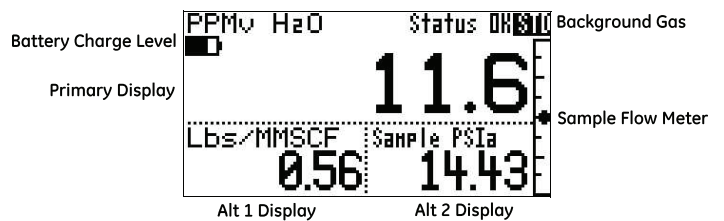



Figure 6: Default display

3.3.3 Unlocking the keypad

After power-on, the **Aurora TransPort** keypad is locked as indicated by the symbol , lit up with a red backlight. It is necessary to enter the keypad unlock sequence to make any changes to the **Aurora TransPort**.

Similar to a mobile phone, the **Aurora TransPort** will prompt the operator to unlock if any key is pressed. A User passcode is required for modifying certain options. A Service passcode is required to adjust factory service features.

To unlock the keypad, press [x] Cancel, [✓] Enter, [x] Cancel in sequence.

3.3.4 Accessing the menus

After successfully unlocking the keypad, press the @ Menu key. The **Aurora TransPort** will display the Main Menu (see *Figure 7* below). Use the arrow keys to highlight the menu item desired. Refer to *Menu Map, Figure 17 on page 38*.

Press **Enter** [✓] to select the highlighted item. Many menu items will display another menu. Use **Cancel** [x] to return to the previous menu page. Pressing **Cancel** [x] from the Main Menu will return the screen to the **Measurement Display**.

Note: Menu items displayed with an ellipsis (shown as a series of three dots after the menu item) will bring up more choices, while those without take immediate action.



Figure 7: Main menu

3.3.5 Entering numeric values

Since the **Aurora TransPort** has no numeric keypad, numeric values are entered using a “combination lock” style of entry: Use the **left** [◀] and **right** [▶] arrow keys to select the digit to change. The digit selected will be indicated with a [Δ].

Use the **up** [Δ] and **down** [▽] arrow keys to increment or decrement the digit.

Note: If incrementing or decrementing a digit would cause the numeric value to exceed its allowable range (maximum/minimum value), the digit will not change.

Press **Enter** [✓] to save the new value and return (see *Figure 8* below), or **Cancel** [x] to return, leaving the original value intact.

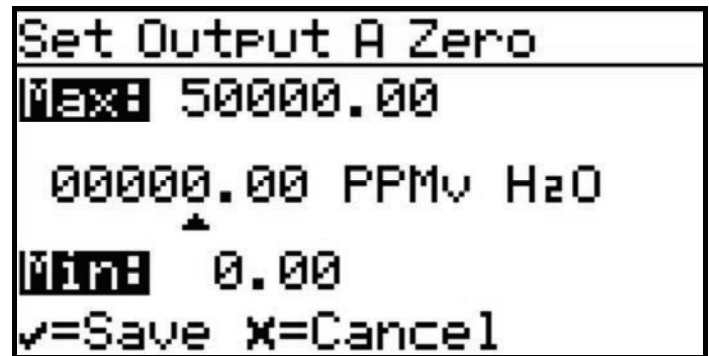
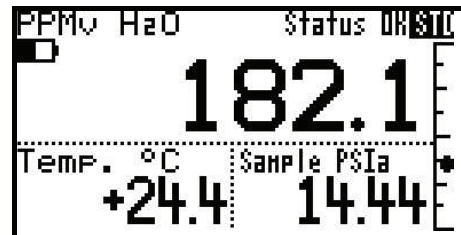

Figure 8: Numeric entry

3.3.6 Starting up

After proper installation, the **Aurora TransPort** Transmitter can be set up to accommodate the user's requirements. Typically, the user may need to configure the analog outputs, trim the analog outputs, and program the digital outputs. Refer to the *Menu Map, Figure 17 on page 38*, and complete the following steps. Upon startup, the **Aurora TransPort** proceeds through several displays until a screen similar to the following appears:



After startup, the screen will need to be unlocked. To unlock the screen, select [x] **Cancel**, [✓] **Enter**, [x] **Cancel** in sequence.

Note: In most instances; use the **Enter** key to save an entry and/or move ahead to the following screen; use the **Cancel** key to reject an entry and/or return to the previous screen.

3.4 Setting up the display

When the screen is unlocked, touch the **Menu** key and the Main Menu appears with several options. To set up the display, select Display ... and press **Enter**. The following screen appears:



3.4.1 Selecting primary units

To select units for the primary display, select Primary and press **Enter**. The following screen appears:



Use the arrow keys to highlight the desired units and press **Enter**. The screen returns to the Display Menu.

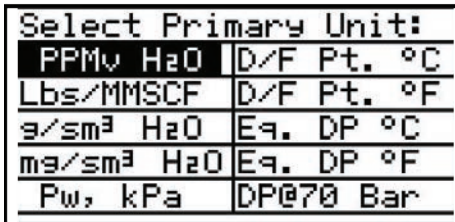

3.4.2 Selecting Alt 1 and Alt 2 units

To set the units for Alt 1 and/or Alt 2, use the arrow keys to highlight the one to be set, and press **Enter**. The following screen appears:



Use the arrow keys to highlight the desired unit type (Hygro, Temperature or Pressure) and press **Enter**. If Temp is selected, the following screen appears.

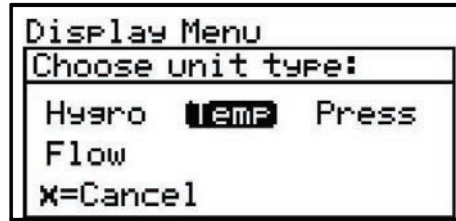

Use the arrow keys to highlight the desired unit and press **Enter**. The screen to the Display Menu . Use the same procedure to change other units.

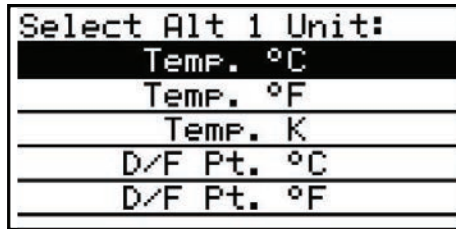

3.4.3 Setting decimal places

To set the decimal places for unit values, from the Display Menu use the arrow keys to highlight Decimal and press **Enter**. Then select the type of display and press **Enter**.

The decimal places setting determines the number of digits displayed for the value to the right of the decimal symbol ("."), if possible.

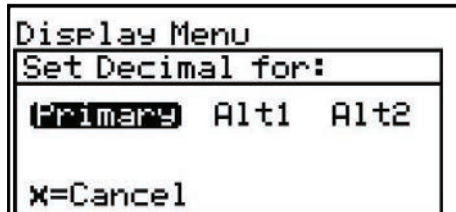

Use the arrow keys to change the number of decimal places and press **Enter**, or press **Cancel** if no changes are necessary. The screen returns to the Display Menu.

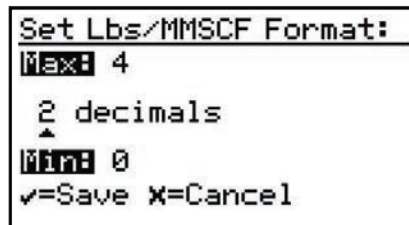

3.4.4 Data/Scan

To toggle the display between showing the numeric values (data), and a graphic plot of the 2f waveform (scan), from the Display Menu use the arrow keys to highlight Data/Scan and press **Enter**. A screen similar to the following appears.

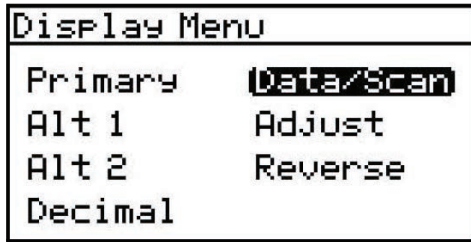

Note: The scan can be used for diagnostic purposes when a PC with **AuroraView** is not readily available.

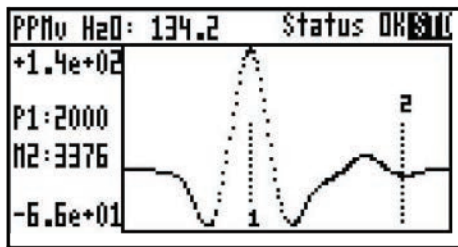

3.4.5 Adjust

To modify the display contrast and brightness, from the Display Menu use the arrow keys to highlight Adjust and press **Enter**. The following screen appears.

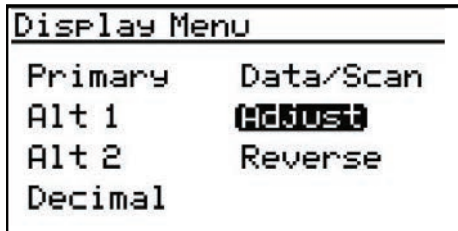

Use the Right/Left arrow keys to increase/decrease display contrast. Press Enter to save the changes, or press Cancel to return to the previous setup. The screen returns to the Display Menu.

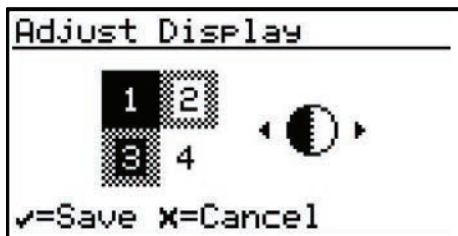

3.4.6 Reverse

To reverse the text and background shades, from the Display Menu use the arrow keys to highlight Reverse and press **Enter**. The following screen appears.



To return to the previous shade setup, select Reverse and press **Enter**. The previous screen appears.



3.5 Setting up the outputs

3.5.1 Selecting an output for setup

To set up outputs, from the Main Menu choose Outputs... and press **Enter**. The following screen appears.



From the Output Menu choose Select and press **Enter**. The following screen appears.



Use the arrow keys to select the output (A, B or C) to be set up, and press **Enter**.

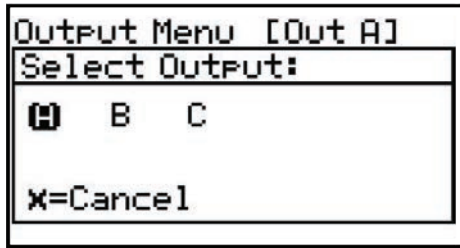

3.5.2 Selecting output units

To adjust the output units, from the Output Menu select Units and press **Enter**. A screen similar to the following appears.

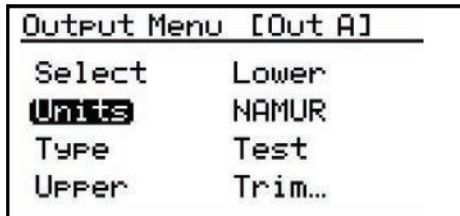

Use the arrow keys to select the unit type and press **Enter**. A screen similar to the following appears:

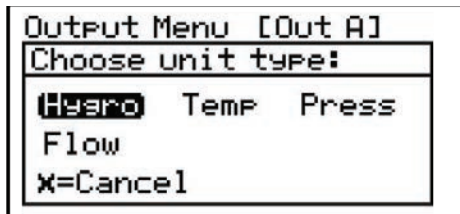

Use the arrow keys to select a new unit. Press **Enter** to save (or **Cancel** to keep the previous value), and return to the Output Menu.

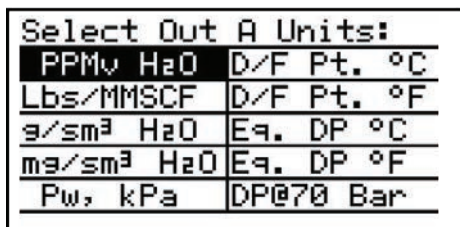

3.5.3 Selecting an output type

To change the output type, from the Output Menu select Type and press **Enter**. A screen similar to the following appears:

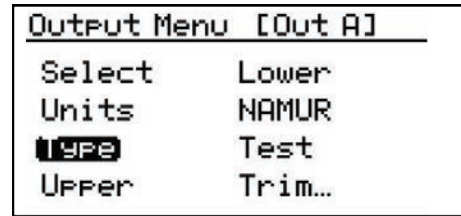

Use the arrow keys to select a new output type. Press **Enter** to save (or **Cancel** to keep the previous value), and return to the Output Menu.

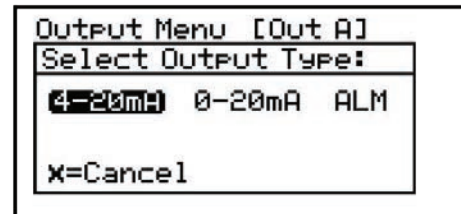

Note: If the **ALM** option is selected in the above menu, the analog output will function as an alarm indicator. In this mode, the analog output will remain at 0 mA during normal operating conditions, but the analog output will be driven to 24 mA whenever there is an alarm condition.

3.5.4 Changing the upper output span

To adjust the upper output span, from the Output Menu select Upper and press **Enter**. A screen similar to the following appears.

```
Output Menu [Out A]
-----
Select      Lower
Units      NAMUR
Type       Test
UPPER     Trim...
```

Use the left and right arrow keys to select each digit to be changed and the up and down arrow keys to increase or decrease its value. Press **Enter** to save (or **Cancel** to keep the previous value), and return to Output Menu.

```
Set Output A Span
-----
Max +100.00
+045.00 Eq. DP °C
  ^
Min -100.00
√=Save X=Cancel
```

3.5.5 Changing the lower output span

To adjust the lower output span, from the Output Menu select Lower and press **Enter**. A screen similar to the following appears.

```
Output Menu [Out A]
-----
Select      Lower
Units      NAMUR
Type       Test
UPPER     Trim...
```

Use the left and right arrow keys to select each digit to be changed and the up and down arrow keys to increase or decrease its value. Press **Enter** to save (or **Cancel** to keep the previous value), and return to Output Menu.

```
Set Output A Zero
-----
Max +100.00
-035.00 Eq. DP °C
  ^
Min -100.00
√=Save X=Cancel
```

3.5.6 NAMUR response

The **Aurora TransPort** can report measurement failure information via the analog outputs. The signal presentation of failure information is consistent with by the recommendations established by the “User Association of Automation Technology in Process Industries” (NAMUR) published in NE43, version 03.03.2003. When configured for 4–20mA operation, faults and errors are indicated by specific output levels shown in *Figure 9* below:

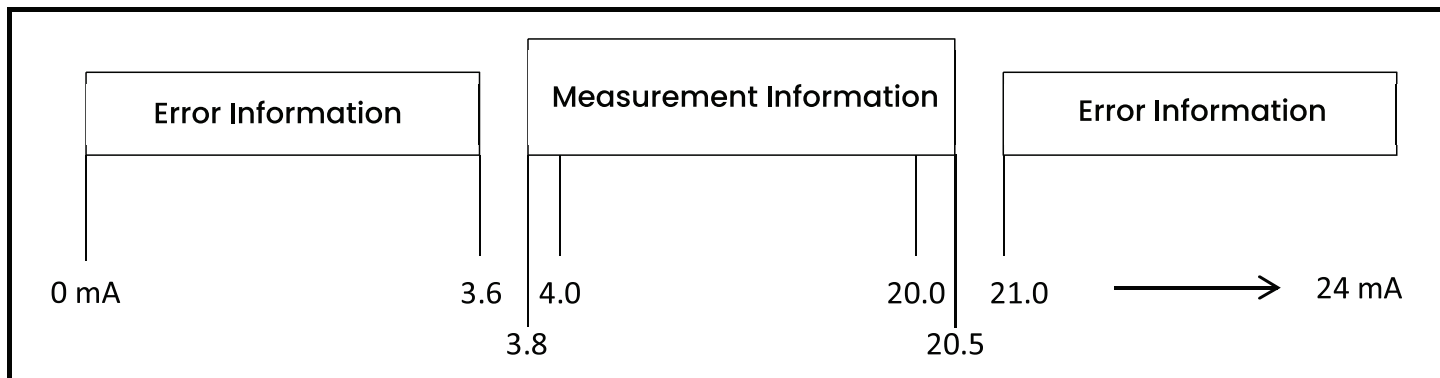

Figure 9: NAMUR output value ranges

In normal operation, a valid measurement is indicated with a signal between 3.8 and 20.5 mA. The Lower (Zero) and Upper (Span) settings determine the measurement value assigned to 4.0 and 20.0 mA, respectively.

For the measurement assigned to an output, the **Aurora TransPort** continuously checks if an error has occurred. If an error has occurred, the output will be driven to a current which is within the Error Information bands displayed above. The **Aurora TransPort** can signal 3.5 mA (‘NAMUR Low’) or 21.1 mA (‘NAMUR High’). These values are well within the Error Information bands as specified by NAMUR (see *Table 1* below).

Note: The Aurora TransPort will never produce a signal between 3.6–3.8 mA or between 20.5–21.0 mA, to allow for reliable discrimination between a measurement and an error.

Table 1: Signal messages

Error	Description	Signal
Under range	The measurement is less than the calibrated range of the analyzer	NAMUR Low
Over range	The measurement is greater than the calibrated range of the analyzer	NAMUR High
Out of range	Calculation error or associated measurement (Temp/Pressure) invalid	NAMUR High
No data	Measurement value has not been calculated yet	NAMUR High
No calibration	Moisture calibration table empty/ invalid	NAMUR High

3.5.7 NAMUR filtering

There may be situations where the NAMUR signaling behavior is undesirable (see *Table 2* below). For example, a process operating at or near the **Aurora TransPort** calibration limits, or when connected to a SCADA or DCS system that cannot correctly distinguish between a measurement and an error signal. In these cases, the NAMUR reporting behavior can be suppressed (“inhibited”). From the Output menu, select NAMUR:

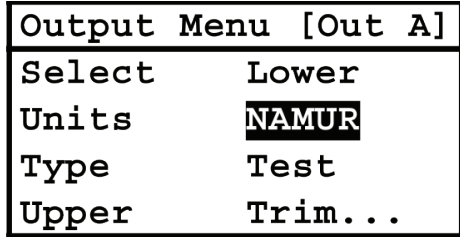

Then select the error(s) to inhibit:

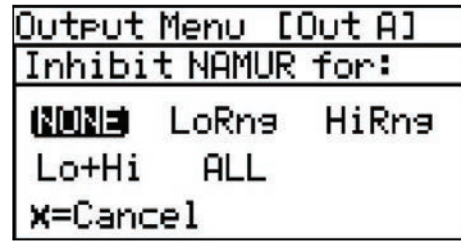

Table 2: NAMUR filters

Selection	Result
NONE	No errors are inhibited; NAMUR signaling will occur for any error as shown in the table above.
LoRng	Under Range errors are inhibited; NAMUR signaling will NOT occur for Under Range error conditions. NAMUR signaling will occur for all other errors in the table above.
HiRng	Over Range errors are inhibited; NAMUR signaling will NOT occur for Over Range error conditions. NAMUR signaling will occur for all other errors in the table above.
Lo+Hi	Under Range AND Over Range errors are inhibited; NAMUR signaling will NOT occur for these error conditions. NAMUR signaling will occur for all other errors in the table above.
ALL	ALL errors are inhibited; NAMUR signaling will NOT occur for any error in the table above.

3.5.8 Testing the output

The Test Menu causes the **Aurora TransPort** to generate a 0- or 4-20mA output at the percent of scale selected. For example, in 4-20 operation, 0% = 4mA, 50% = 12mA, 100% = 20mA. This allows the proper function of recording or SCADA equipment to be verified. In 0-20 operation, 0% = 0mA, 50% = 10mA, 100% = 20mA.

Output Menu [Out A]	
Select	Lower
Units	NAMUR
Type	Test
Upper	Trim...

To test system output, from the Output Menu select Test and press Enter. A screen similar to this display will appear.

Note: Use the left and right arrow keys to select each digit to be changed, and the up and down arrow keys to increase or decrease its value.

Output A Test Value:	
Max	+110.00
	+050.00 %
	▲
Min	-25.00
✓=Apply X=Exit	

Note: The output value will change immediately, it is not necessary to select Apply.

Press **Cancel** to return to the Output Menu.

3.5.9 Trimming the outputs

The Trim Menu enables the operator to compensate for differences in measurement of the 0/4-20 mA outputs by connected recorders or SCADA equipment. To trim the output:

Select Trim from the Output Menu and press Enter. The following screen appears.

Note: The trim applies to whichever output is chosen with the Select menu item, and displayed on the menu title bar.

Output Menu [Out A]	
Select	Lower
Units	NAMUR
Type	Test
Upper	Trim...

When performing a Trim operation, the **Aurora TransPort** unit requires you to first reset the trim. To reset the trim output, highlight Reset Trim and press **Enter**. The following screen appears.

Trim Menu [Out A]	
Reset Trim	
Trim Zero	
Trim Set up	

Use the left or right arrow keys to highlight YES and press **Enter**. This cancels any previous trim values, and returns the **Aurora TransPort** to its factory adjustment. The display returns to the previous screen with Trim Zero highlighted.

Trim Menu [Out A]	
Reset Out A Trim?	
YES	NO
X=Cancel	

To trim the zero value, press **Enter**. A screen similar to the following appears.

This will cause the **Aurora TransPort** to output 4.000 mA on the output being trimmed. The output value should then be read using the connected recorder, SCADA equipment, or DVM. Enter the value read from the connected equipment as the Zero Trim value, as follows:

Trim Menu [Out A]	
Reset Trim	
Trim Zero	
Trim Set up	

Use the left and right arrow keys to select each digit to be changed, and the up and down arrow keys to increase or decrease its value. Press **Enter** to save (or **Cancel** to keep the previous value).

Note: Since you cannot trim 0 mA for negative offsets, trim for the lower end of the scale is at the 4 mA output level.

Enter Out A Readings:	
Max	5.2000
	03.9750 mA
	▲
Min	3.0000
✓=Save X=Cancel	

The Trim Menu returns with Trim Span highlighted. To change the span value, press Enter. A screen similar to the following appears.



This will cause the Aurora TransPort to output 20.000 mA on the output being trimmed. The output value should then be read using the connected recorder, SCADA equipment, or DVM. Enter the value read from the connected equipment as the Span Trim value.

Use the left and right arrow keys to select each digit to be changed, and the up and down arrow keys to increase or decrease its value. Press Enter to save (or Cancel to keep the previous value).

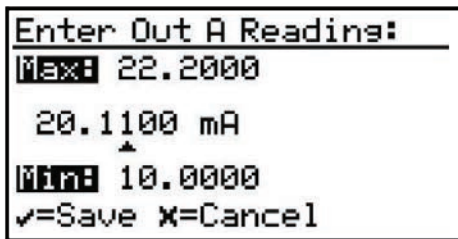

Trimming is complete. Accuracy can be verified using the Test Menu, above.

Example: Trim is reset, then Trim Zero is selected. The SCADA input reports 3.975 mA. The operator enters "3.9750" as the Zero Trim value. Trim Span is selected. The SCADA input reports 20.110 mA. The operator enters "20.1100" as the Span Trim value.

Aurora TransPort adjusts the output accordingly to true the output as read by the customer recorder, SCADA or DVM. Using the Test Menu, the operator verifies that a test value of 0% now reads 4.000 mA at the SCADA equipment, and a test value of 100% now reads 20.000 mA.

3.6 Setting up the alarms

Note: The **Aurora TransPort** is **not** equipped with alarm relays. Alarm status can be obtained via Modbus, or an Analog Output can be configured as an alarm signal (see "Selecting an Output Type" on page 13).

3.6.1 Selecting an alarm output

To set up alarm outputs, on the Main Menu choose Alarm and press Enter. From the Alarm Menu choose Select and press Enter. A screen similar to the following appears.



Use the arrow keys to select the output (A, B or C) to be set up and press Enter. The display returns to the Alarm Menu.

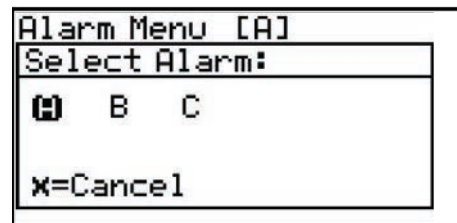

3.6.2 Selecting alarm status

To select the alarm status, from the Alarm Menu select Status and press Enter. The following screen appears:

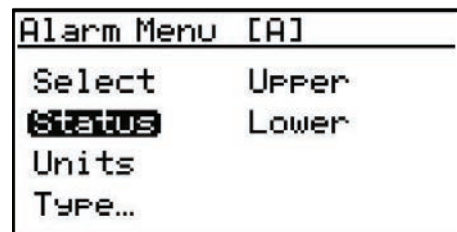

Use the arrow keys to select OFF or ON and press Enter. The display returns to the Alarm Menu.

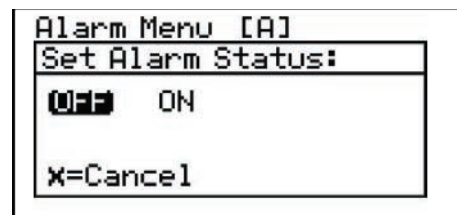

3.6.3 Selecting alarm units

To select alarm units, from the Alarm Menu select Units and press **Enter**. Use the arrow keys to select the unit type and press **Enter**.

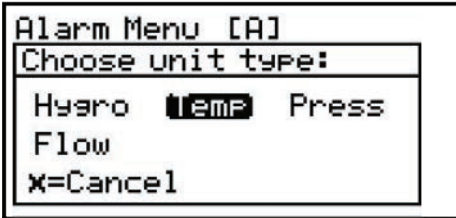

If Temp was selected, this display appears. Use the arrow keys to select a unit. Press **Enter** to save (or **Cancel** to keep the previous value), and return to the Alarm Menu.



If Temperature was selected, this display appears. Use the arrow keys to select a unit. Press **Enter** to save (or **Cancel** to keep the previous value), and return to the Alarm Menu.

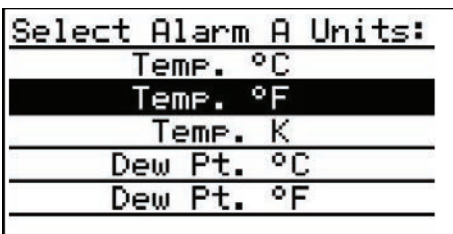

If Pressure was selected, this display appears. Use the arrow keys to select a unit. Press **Enter** to save (or **Cancel** to keep the previous value), and return to the Alarm Menu.

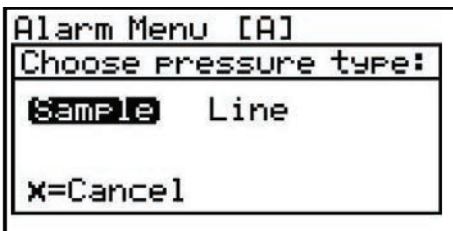

3.6.4 Selecting an alarm type

To change the alarm type, from the Alarm Menu select Type and press **Enter**. A screen similar to the following appears:

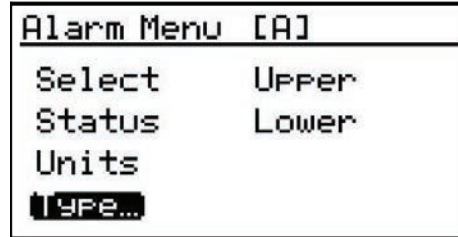

Use the arrow keys to select an alarm type. Press **Enter** to save (or **Cancel** to keep the previous value), and return to the Alarm Menu.

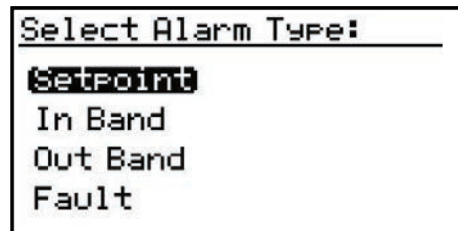

- **SetPoint:** Alann activates when parameter exceeds upper limit, and deactivates when parameter is less than lower limit.
- **Inner Band:** Alann activates when parameter is between upper and lower limits.
- **Outer Band:** Alann activates when parameter is outside upper and lower limits.
- **Fault:** Alann activates when a system fault is detected. The alarm de-activates when the fault condition is removed. These conditions can be found in Section 7.4, *Table 4*.

3.6.5 How the alarm types work

See Figure 10 below for descriptions of the various alarm types:

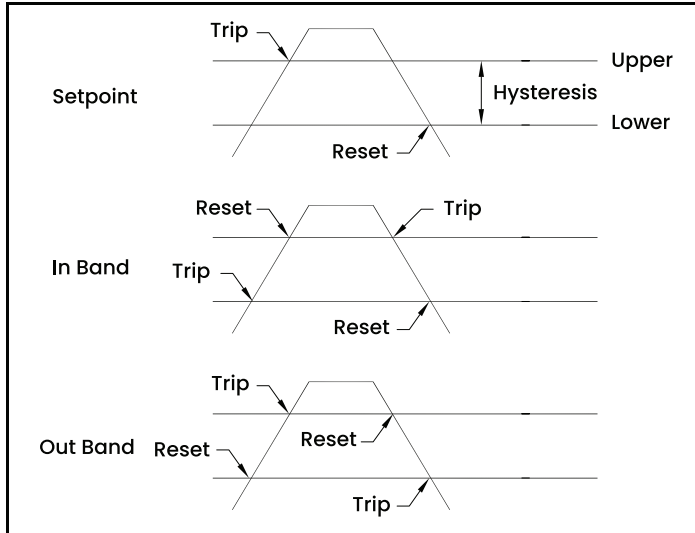
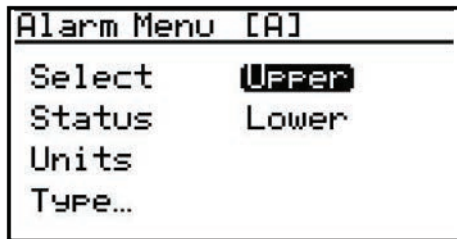

Figure 10: Example of alarm types

3.6.6 Changing the upper alarm span

To adjust the upper alarm span, from the Alarm Menu select Upper and press **Enter**. A screen similar to the following appears.



Use the left and right arrow keys to select each digit to be changed and the up and down arrow keys to increase or decrease its value. Press **Enter** to save (or **Cancel** to keep the previous value), and return to Alarm Menu.



3.6.7 Changing the lower alarm span

To adjust the lower alarm span, from the Alarm Menu select Lower and press **Enter**. A screen similar to the following appears.

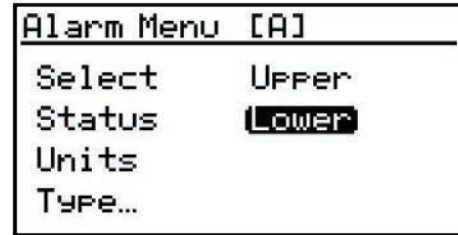

Use the left and right arrow keys to select each digit to be changed and the up and down arrow keys to increase or decrease its value. Press **Enter** to save (or **Cancel** to keep the previous value), and return to Alarm Menu.



Chapter 4. Programming advanced features

4.1 Comm port settings

To access the communication port settings, from the Main Menu select Settings and press **Enter**. The following screen appears:



To access the communications port settings, select Comms... and press **Enter**. The following screen appears:



4.1.1 Selecting a Comm port

There are two physical comm ports in the **Aurora TransPort**. Comm Port 1 is aligned to SCADA in the instrument program and Comm Port 2 is aligned to SERVICE. This setup enables the user to have Comm Port 1 set up for the primary digital output (for example, RS-485 to the customer SCADA system), and Comm Port 2 to be used for service (for example, to enable a service engineer to interface with the **Aurora TransPort** using an RS-232 cable connected to a laptop PC in the field, running **AuroraView** software).

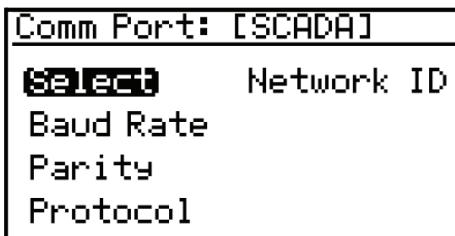

To select a communication port, use the arrow keys to highlight Select and press **Enter**. The following screen appears.

Select SCADA or SERVICE and press **Enter**. The screen returns to the Comm Port Menu.

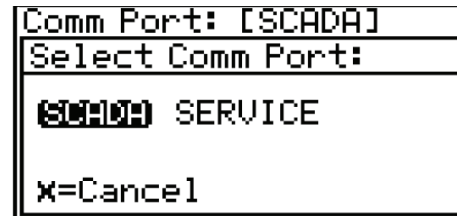

4.1.2 Setting the Baud rate

To set the baud rate, from the Comm Port Menu select Baud Rate and press **Enter**. The following screen appears.

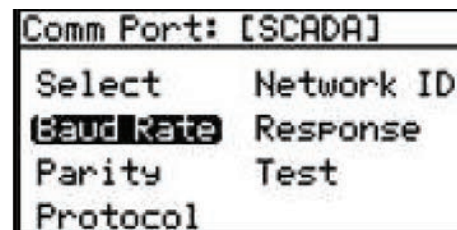

Use the arrow keys to highlight the desired baud rate and press **Enter**. The screen returns to the Comm Port Menu.

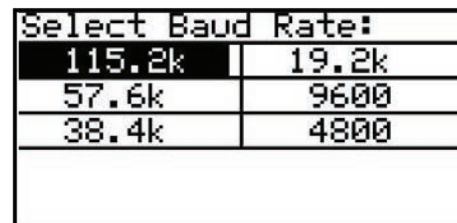

4.1.3 Setting the parity

To set parity, from the Comm Port Menu select Parity and press **Enter**. The following screen appears.

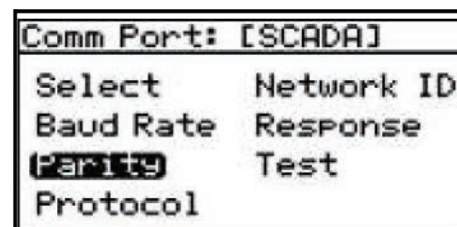

Use the arrow keys to highlight the desired parity and press **Enter**.

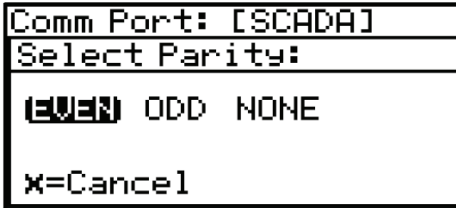

After a parity selection is made, the Aurora prompts for the number of stop bits. Use the arrow keys to highlight the desired number and press **Enter**. The screen returns to the Comm Port Menu.

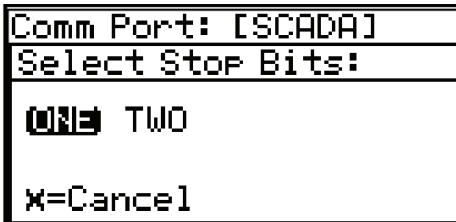

4.1.4 Selecting the protocol

To choose the protocol, from the Comm Port Menu select Protocol and press **Enter**. The following screen appears.

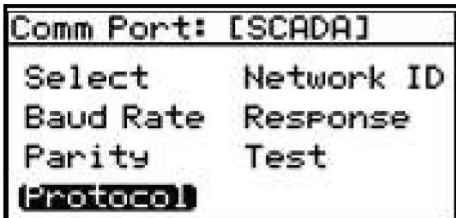

Use the arrow keys to highlight the desired protocol and press **Enter**. The screen returns to the Comm Port Menu.

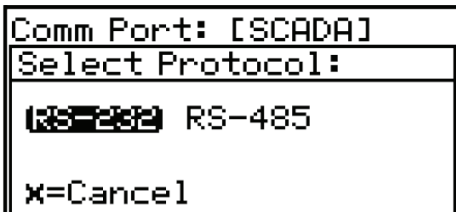

4.1.5 Setting the network ID

To set the network ID, from the Comm Port Menu select Network ID and press **Enter**. The following screen appears.

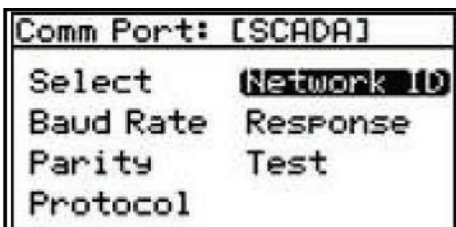

Use the left and right arrow keys to select each digit to be changed. Use the up and down arrow keys to change the value. When finished, press **Enter**. The screen returns to the Comm Port Menu.

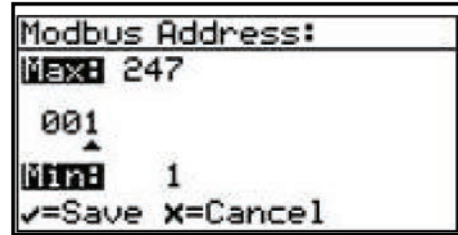

4.1.6 Adjusting the response delay

Some Modbus masters may have limitations in their ability to receive a response immediately after transmitting the request. This can often occur when the RS-485 protocol is used, as the Master must change from transmit to receive operation. The Aurora TransPort response can be delayed by a user-specified amount to accommodate these limitations.

To change the response time, from the Comm Port Menu select Response and press **Enter**. The following screen appears.

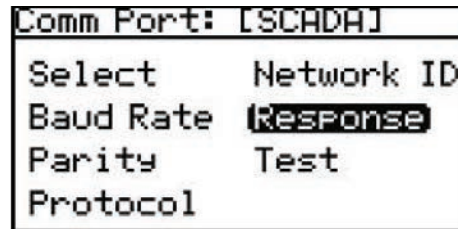

Use the left and right arrow keys to select each digit to be changed. Use the up and down arrow keys to change the value. When finished, press **Enter**. The screen returns to the Comm Port Menu. A value of zero permits the Aurora to respond immediately. Do not specify a response delay longer than absolutely necessary, as this limits message throughput.

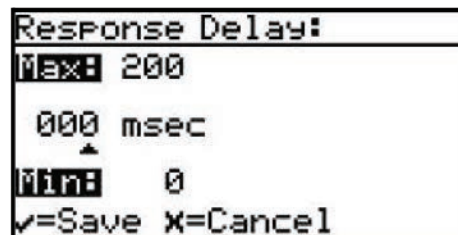

4.1.7 Serial port test

To aid in establishing or troubleshooting problems with serial communications, the Aurora TransPort can be placed in Serial Port Test mode, using a serial terminal or terminal emulation software. Configure the terminal to the same parameters specified for the Aurora TransPort in “Setting the Baud Rate” on page 21, “Setting the Parity” on page 21 and “Selecting the Protocol” on page 22.

Note: Modbus communications are not possible via the port under test.

To change the response time, from the Comm Port Menu select Test and press **Enter**. The following screen appears.



Enable Test mode by selecting ON and pressing **Enter**. The Aurora TransPort transmits SCADA waiting or SERVICE waiting (see *Figure 11* below), depending on the port being tested.

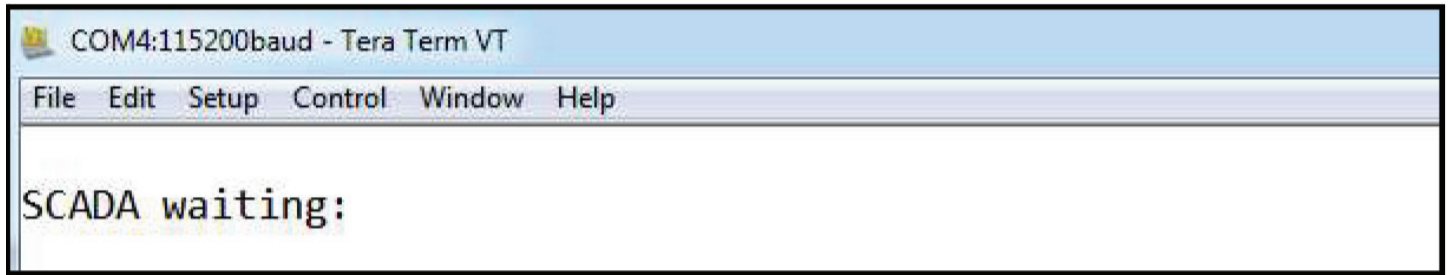

Figure 11: Sample “SCADA Waiting:” screen

Type a character at the terminal. If the character is received correctly, the hexadecimal value of the character sent will be returned (see *Figure 12* below). If the character is not returned, this is usually due to incorrect parity or stop-bit settings. If the initial waiting prompt is not seen or is garbled, this is an indication of an incorrect baud rate setting.

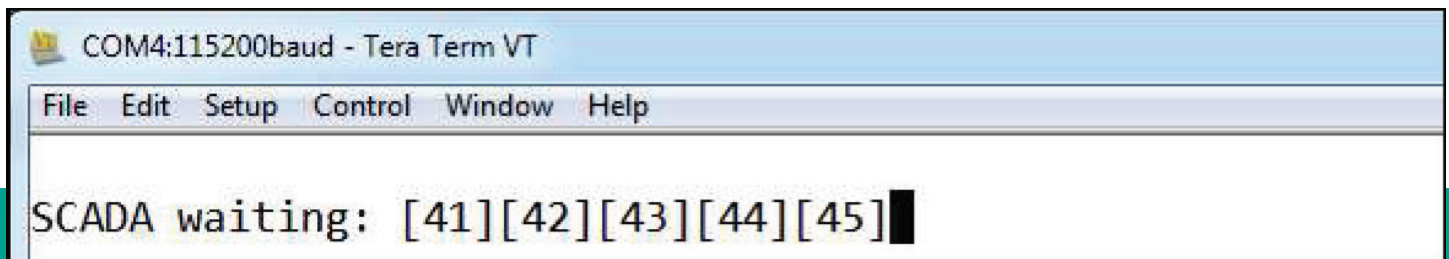

Figure 12: Response to “ABCDE” entry

Note: The Aurora TransPort will remain in test mode until it is turned off or it is reset or power-cycled.

4.2 Ethernet settings

The Aurora TransPort supports Modbus/TCP over Ethernet. This enables remote access to measurement and diagnostic data whenever an Ethernet LAN connection is available.

4.2.1 Connection to the Internet/WAN



WARNING!

The Ethernet option provided in the Aurora TransPort is designed for use on a limited-access Local Area Network (LAN) protected by a suitable firewall. It should not be operated if exposed to the Internet or other unmanaged Wide Area Network (WAN). Check with your network administrator to determine whether it is safe to connect the Aurora TransPort to your network infrastructure.

4.2.2 Default passwords



WARNING!

The Ethernet option in the Aurora TransPort is based on technology from Digi International Inc. It includes built-in HTTP (web) and Telnet servers to provide administrative access and control. As shipped from the factory, there are two accounts enabled, with default passwords assigned. These default passwords are public knowledge, and widely distributed.



WARNING!

It is **IMPERATIVE** that the default passwords be changed before placing the Aurora TransPort into service!

4.2.3 Connecting to an Ethernet LAN

The Ethernet option supports the IOBase-T and IOBase-TX twisted-pair Ethernet standards. A waterproof RJ45 connector is provided for use with standard CAT5/CAT5e Ethernet cables. Use of Shielded Twisted Pair (STP) cable is recommended.

To access the Ethernet Settings menu, enter the User passcode (2719 is the default). As shipped, the Aurora TransPort Ethernet is disabled (Status is 'Disabled'), and the menu options are grayed out. To activate the Ethernet port, select the Status option and press Enter. The following screen appears.

```
Ethernet Settings
[Status]
Protocol
Factory Reset
```

```
Ethernet Settings
Ethernet Status
Disabled [Enabled]
X=Cancel
```

After Ethernet is enabled, the remaining menu options are available. When the Status is set to Disabled, power is removed from the module, effectively unplugging it from the Ethernet network. If the Status is returned to Enabled, there will be a delay of up to one minute before the module completes its *Power On Self Test (POST)* and becomes visible on the Ethernet network. After selecting the desired option, press **Enter**.

```
Ethernet Settings
[Status]
Protocol
Factory Reset
```

Selecting Factory Reset from the Ethernet Settings menu returns the Ethernet module to its default state, which takes approximately 15 seconds to complete. After a Factory Reset, the module enables DHCP, reset passwords to their defaults, disables Modbus/TCP, and enables RealPort (serial emulation) mode.

After a Factory Reset, it is necessary to log in via the HTML or Telnet command interface, and reconfigure the network and Modbus settings (see *Appendix B. "Aurora TransPort Ethernet Operation"* for detailed instructions).

```
Ethernet Settings
Status
Protocol
[Factory Reset]
```

Selecting Protocol from the Ethernet Settings menu allows choosing the method of Modbus data transport:



MB/TCP selects the Modbus/TCP protocol. This is the most efficient means of transferring Modbus data over a network.

MB/RTU transfers the data as serial Modbus. This method may be used with a Modbus master that does not support Modbus/TCP. This requires the use of a compatible Virtual Serial Port on the Modbus master.

4.2.4 IP address assignment

By default, Aurora uses the Dynamic Host Configuration Protocol (DHCP) to obtain an Internet Protocol (IP) address from the network controller or router. If a DHCP server is not available, a static IP address must be selected and assigned. This is performed via the HTTP or Telnet interface.

If an IP address is obtained from a DHCP server, that server may be used to identify the IP address assigned, or the IP address may be determined with a Device Discovery Utility.

If no DHCP server is provided, after several minutes the Aurora will default to a Link Local Address per IETF RFC 3927. The Aurora will assign itself a random IP address in the range of 169.254.1.0 - 169.254.254.255.

4.2.5 Device discovery

The Digi module used for Ethernet connectivity supports Digi's ADDP (*Advanced Device Discovery Protocol*). ADDP uses UDP port 2362 and a multicast IP address of 224.0.5.128. You will need to enable these on your firewall for the ADDP protocol to work for the device discovery utility.

Digi provides two utilities, *Digi Device Discovery* (for Microsoft Windows only), and Digi Port Authority (available for Microsoft Windows, AIX, HP-UX, Solaris, and many Linux distributions). These utilities can be downloaded from the Digi support web site at: <http://www.digi.com/support/>. After the utility is installed, the Aurora TransPort connected to the LAN, and the Ethernet option enabled, Device Discovery will identify it (see Figure 13 below):

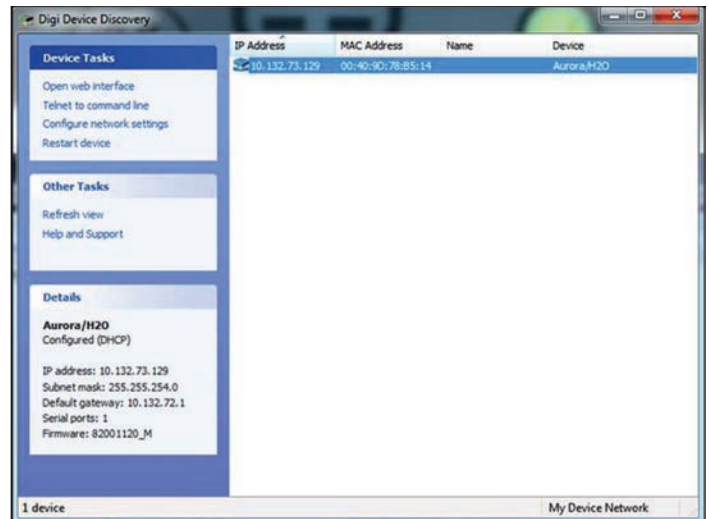

Figure 13: Digi device discovery screen

Advanced configuration may then be performed by opening a web browser or telnet session to the IP address listed for the Aurora TransPort. See Appendix B. "Aurora TransPort Ethernet Operation" for detailed instructions.

Note: The Ethernet module is not enabled and the Aurora TransPort will not be visible on the network until the Aurora completes laser startup.

4.3 Adjust offset values

To adjust offset values, from the Settings Menu select Adjust... and press **Enter**. The following screen appears.



4.3.1 Adjusting the PPMv offset

To adjust the PPMv offset, select PPM Level and press **Enter**. The following screen appears.



Use the left and right arrow keys to select each digit to be changed. Use the up and down arrow keys to change the value. When finished, press **Enter**. The screen returns to the User Adjustments Menu.

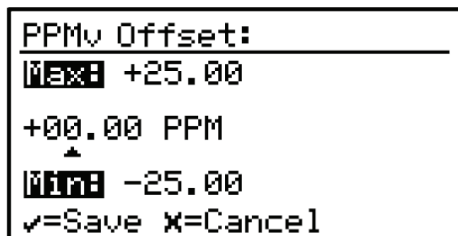

4.3.2 Adjusting the smoothing filter

To adjust the smoothing filter, from the User Adjustments Menu select Filter and press **Enter**. The following screen appears.

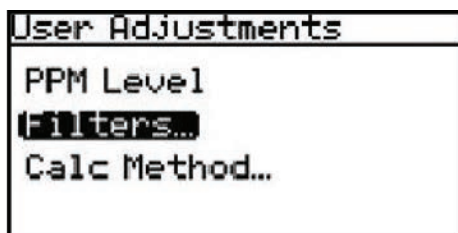

Select Smoothing and press **Enter**. The following screen appears.



The Smoothing Filter setting is used to change the system responsiveness. It is a moving average filter to smooth the moisture readings. The minimum setting is 1scan and the maximum setting is 501 scans. The default value of 128 scans, is set at the factory prior to shipment.

Use the left and right arrow keys to select each digit to be changed. Use the up and down arrow keys to change the value. When finished, press **Enter**. The screen returns to the User Adjustments menu.



4.3.3 Adjusting the scan averaging

To adjust the Scan Averaging, from the Filters Menu select Scan Avg and press **Enter**. The following screen appears:



The Scan Average setting is used to change system noise rejection. By averaging entire scans, the Signal/Noise Ratio (SNR) can be increased. This is particularly useful in the presence of certain background gases, which can interfere with the moisture absorption peak, or introduce background noise.

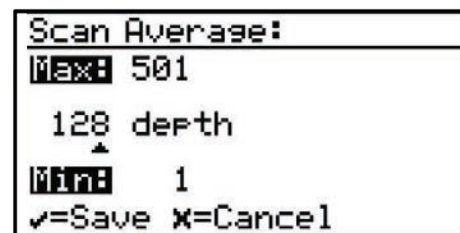

The default Scan Average value set at the factory is 128, which is an optimal tradeoff between noise reduction and system responsiveness. Lowering this value provides faster response time in exchange for a noisier measurement; conversely, increasing the scan average provides a smoother measurement in exchange for slower transient response.

IMPORTANT:

Please contact a Panametrics application engineer before modifying this setting.

Use the left and right arrow keys to select each digit to be changed. Use the up and down arrow keys to change the value. When finished, press **Enter**. The screen returns to the User Adjustments Menu.

4.3.4 Setting the dew point calculation method

- The dew point is the temperature at which the air is saturated with respect to water vapor over a liquid surface.
- The frost point is the temperature at which the air is saturated with respect to water vapor over an ice surface.

There can be a difference of several degrees C between the dew point and the frost point.

- When set for Dew/Frost, the Aurora TransPort will report the Dew Point if the reading is above freezing, and will report the Frost Point if the reading is below freezing.
- When set for Dew Point, the Aurora TransPort will calculate the Dew Point temperature, even if that temperature is below freezing.

To set the dew point calculation method, from the User Adjustments Menu select Dew pt Calc and press **Enter**. The following screen appears.



From the Select Calc Options Menu select Dew/Frost and press **Enter**. The following screen appears.



Use the arrow keys to highlight the desired dew point setting and press **Enter**. The screen returns to the User Adjustments Menu.

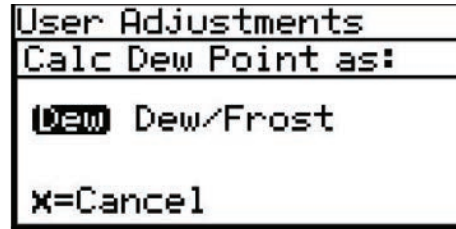

- The Dew calculation should be used for compatibility with ASTM-1142/IGT-8. The tables and calculations in those reports require measurements and provide results in dew point, regardless of the actual phase (dew or frost).
- The Dew/Frost calculation should be used for compatibility with ISO-18453:2004, or when using a chilled mirror apparatus as a check standard.

4.3.5 Saturation calculation

In certain regulatory zones, the *Gosudarstvenii Standart* (GOST) calculation of the Saturation pressure is required, and gives different results from ASTM and ISO methods. Select the calculation that is most appropriate for your application.

To select the appropriate Saturation Calculation method for your application, from the User Adjustments Menu select Calc method and press **Enter**. The following screen appears.

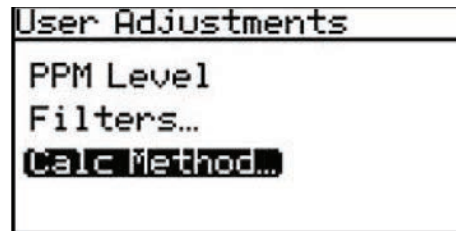

From the Select Calc Options Menu select Saturation and press **Enter**. The following screen appears.

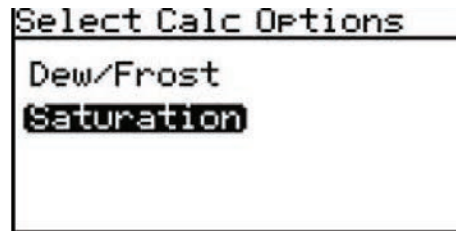

Use the arrow keys to highlight the desired saturation calculation method (ASTM or GOST) and press **Enter**. The screen returns to the User Adjustments Menu.

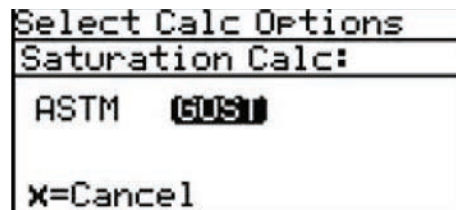

4.4 Set Up the background gas

4.4.1 Selecting the type of gas

The **Aurora TransPort** TDLAS is normally calibrated to a standard gas mixture that is representative of “typical” natural gas. The primary components and concentrations of this gas mixture are:

Component	Concentration
Methane (CH ₄)	90.0%
Nitrogen (N ₂)	10.0%

The process background gas is selectable from the Settings Menu.

- For normal operation in natural gas service, **STD** should be selected as the background gas.
- For verification testing in **pure methane**, select **CH₄**.
- If verifying in **Nitrogen** with a known moisture concentration, **N₂** should be selected as the background gas.

The **Aurora TransPort** displays the selected Background Gas an indicator in the upper right corner of the LCD, adjacent to the status message.

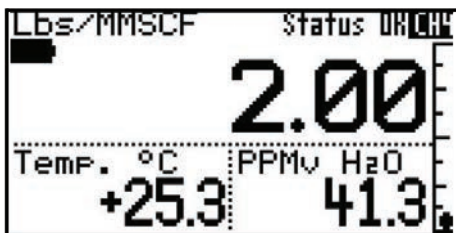
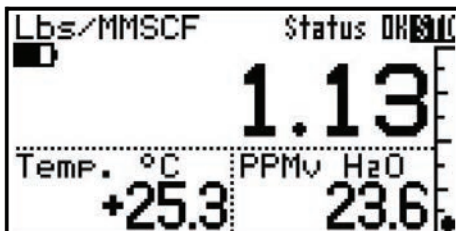
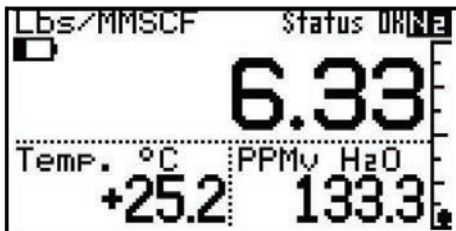

Unless otherwise requested, the **Aurora TransPort** is shipped from the factory configured for Methane operation.

To change the type of background gas, from the Settings Menu select Gas and press Enter. The following screen appears.



From the Gas Data menu, select Background and press Enter. The following screen appears.

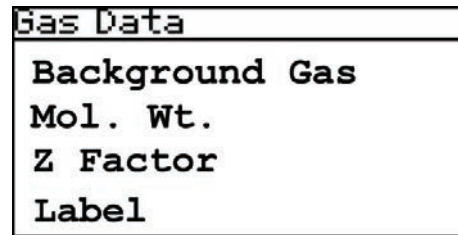

Use the arrow keys to select the desired background gas, and press Enter. The background gas selection is now complete. Press **Cancel** to return to the display page.

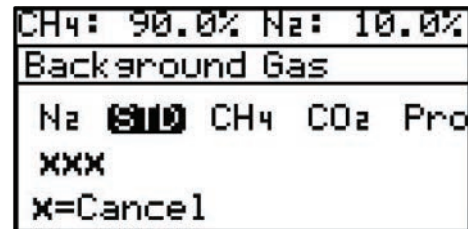

Note: If alternate gases are installed, selecting the alternate gas enables the Label menu item. This allows the user to change the gas label to one of their own choosing. Entering the Label menu requires the User passcode (2719).

4.4.2 Setting the Z factor

The **z factor** is a number that accounts for the non-ideal compressibility of natural gas, and is vital for accurate calculation of mass/volume (lbs/MMSCF, mg/m³).

To set the **Z factor**, from the Gas Data Menu, select Z Factor and press enter. The following screen appears.

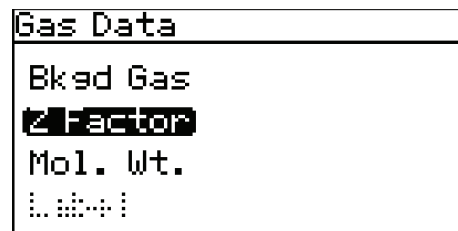

Use the left and right arrow keys to select each digit to be changed. Use the up and down arrow keys to change the value. When finished, press **Enter**. The screen returns to the Settings Menu.

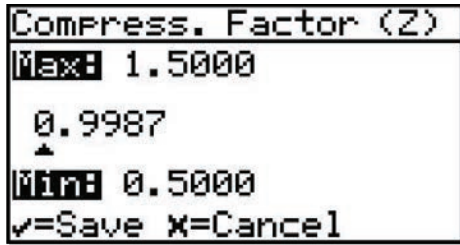

4.4.3 Entering a label

Selecting either Gas 1 or Gas2 enables the Label menu item. This menu opens a keyboard display that allows the user to change the 'Gas/2' label to one of their own choosing. Entering the Label menu requires the User passcode (2719).

To enter/edit a label:

Selecting the Label menu item displays the Alphanumeric Entry control (see Figure 14 below).

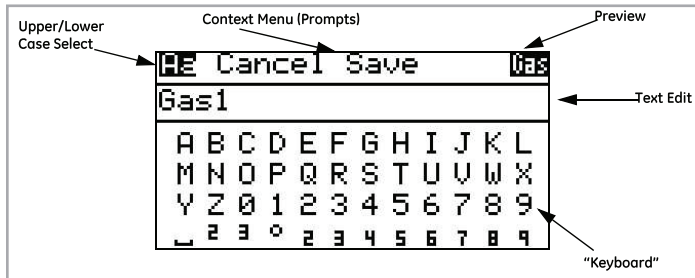

Figure 14: Alphanumeric Entry Control

The Alphanumeric Entry is divided into three sections. The active section will have something highlighted (reverse video). The Up/Down arrows are used to move between sections.

The top section is the **Context Menu**. The 'Aa' toggles the keyboard between upper and lower case (shift key). **Cancel** abandons any changes to the label. **Save** saves any changes made to the label. There is also a 'preview' of how the label will look from the main data display.

- Pressing the Down arrow will move the highlight to the Text Edit section (see Figure 15 below):

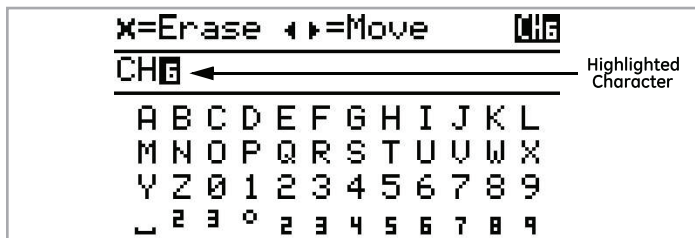

Figure 15: Text Edit

Note that the Context Menu has changed; it displays prompts of available key actions.

- In **Text Edit**, the **Left** and **Right** arrows move the highlight from character to character in the label. Pressing **x** erases the highlighted character.
- Pressing the **Down** arrow will move the highlight to the **Keyboard** section (see Figure 16 below):

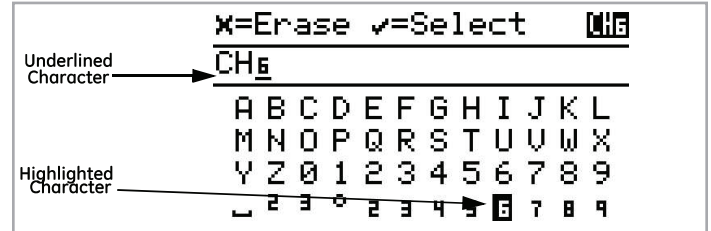

Figure 16: Alphanumeric Menu with Keyboard Highlighted

Note that the **Context Menu** has changed again; it displays prompts of available key actions when in the keyboard. In **Keyboard**, the **Left/ Right/ Up/ Down** arrows move the highlight from character to character in the keyboard.

Note that the character selected in **Text Edit** is now underlined.

- Pressing **Enter** replaces the underlined character with the character highlighted on the keyboard.
- Pressing **Cancel** erases the underlined character. Any characters after the erased character are shifted to the left. If there are no characters after the erased character, the underline moves to the last character in the label.
- When in the **Keyboard**, pressing the **Down** arrow repeatedly will move the highlight down to the next row of 'keys'. When the highlight is on the bottom row, pressing **Down** will move the highlight to the top row.
- Pressing the Up arrow will move the highlight up to the previous row of keys. When the highlight is on the top row, pressing **Up** will switch to the **Text Edit** section.
- From the **Text Edit** section, pressing Up will move the highlight to the **Context Menu** section.
- Choose **Cancel** or **Save** to exit the Label entry.

4.4.4 Adjusting the gas molecular weight

The input information for gas molecular weight is not currently used for any moisture calculations and is reserved for future use.

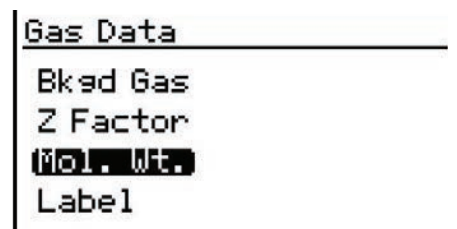

4.5 Clock settings

The clock settings are for informational purposes. They are used to keep track of the test analyzer start time and the laser operational time.

To reset the clock, from the Settings Menu select Clock and press **Enter**. The following screen appears.



4.5.1 Setting the hour

To set the hour, from the Clock Menu select Hour and press **Enter**. The following screen appears.

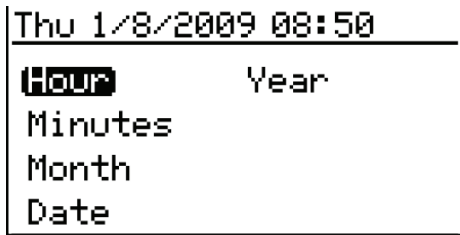

Use the left and right arrow keys to select each digit to be changed. Use the up and down arrow keys to change the value. When finished, press **Enter**. The screen returns to the Clock Menu.

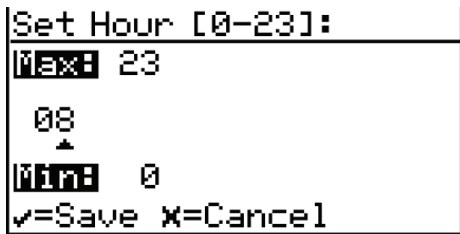

4.5.2 Setting the minutes

To set the minutes, from the Clock Menu select Minutes and press **Enter**. The following screen appears.



Use the left and right arrow keys to select each digit to be changed. Use the up and down arrow keys to change the value. When finished, press **Enter**. The screen returns to the Clock Menu.

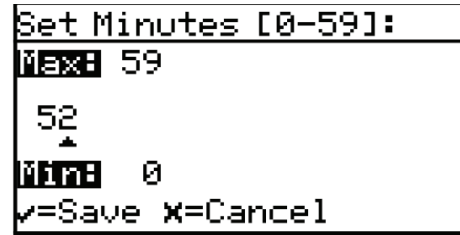

4.5.3 Setting the month

To set the month, from the Clock Menu select Month and press **Enter**. The following screen appears.

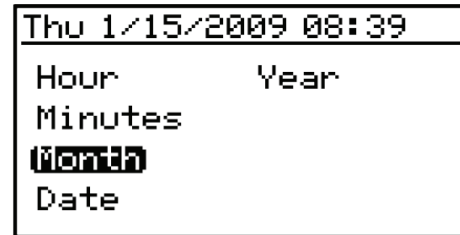

Use the left and right arrow keys to select each digit to be changed. Use the up and down arrow keys to change the value. When finished, press **Enter**. The screen returns to the Clock Menu.

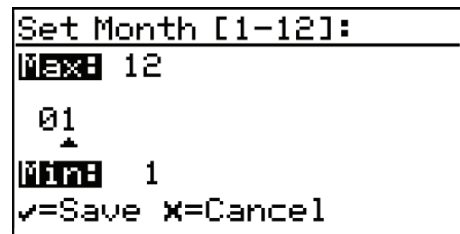

4.5.4 Setting the date

To set the date, from the Clock Menu select Date and press **Enter**. The following screen appears.

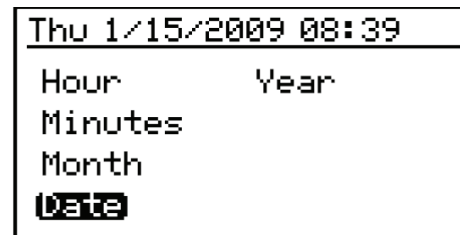

Use the left and right arrow keys to select each digit to be changed. Use the up and down arrow keys to change the value. When finished, press **Enter**. The screen returns to the Clock Menu.

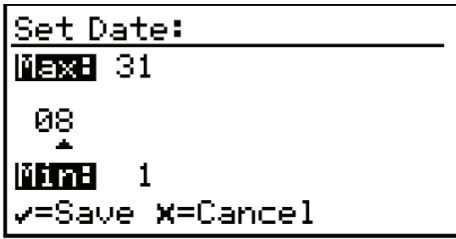

4.5.5 Setting the year

To reset the year, from the Clock Menu select Year and press **Enter**. The following screen appears.

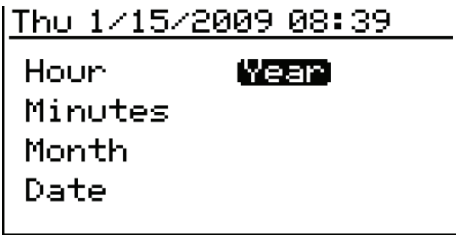

Use the left and right arrow keys to select each digit to be changed. Use the up and down arrow keys to change the value. When finished, press **Enter**. The screen returns to the Clock Menu.

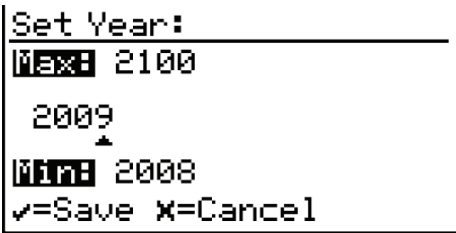

4.6 Pressure settings

The Aurora TransPort makes its moisture measurements and most calculations at a standard pressure of one atmosphere. For Equivalent Dew Point measurements, the Aurora TransPort can be programmed with an pressure value. The pressure value can be a constant, or provided via Modbus.

To modify the pressure settings, from the Settings Menu, select Pressure ... and press **Enter**. The following screen appears.

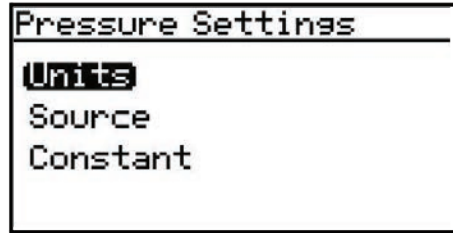

4.6.1 Setting pressure units

To set the pressure units, from the Pressure Menu, select Units and press **Enter**. You can then choose from: kPa(a) (Kilopascals Absolute), Bar g- (Bars gauge), or PSI g-(Pounds per Square Inch gauge).

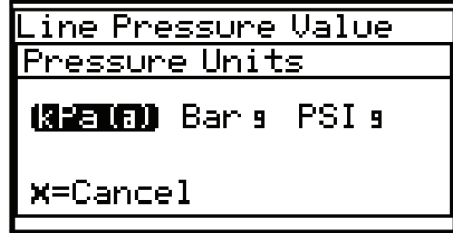

4.6.2 Setting the source

To reset the source, from the Pressure Menu, select Source and press **Enter**. The following screen appears.

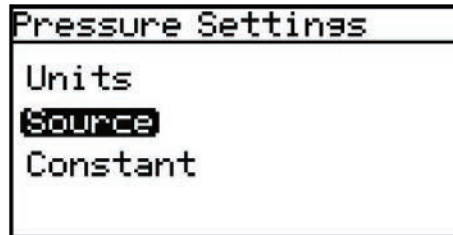

Use the left and right arrow keys to select the line pressure source. Live accepts a pressure value from a pressure transmitter and **Remote** accepts a value via a Modbus connection. To set a constant value, select Constant and press **Enter**. The screen returns to the Pressure Menu.

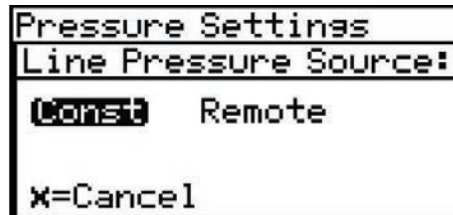

4.6.3 Changing the constant

If the pressure source selected is Constant, to reset its value, select Constant from the Pressure Menu and press **Enter**. The following screen appears.

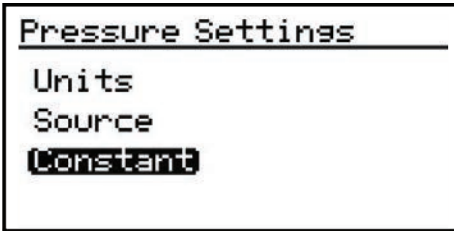

Use the left and right arrow keys to select each digit to be changed. Use the up and down arrow keys to change the value. When finished, press **Enter**. The screen returns to the Pressure Menu.

Note: Data entry for this setting is in the units selected in Section 4.6 above.

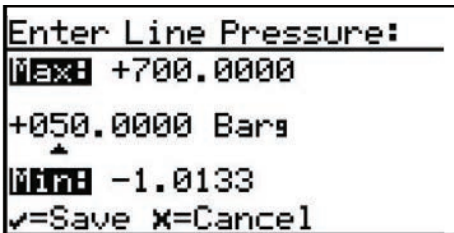

4.7 Regional settings

This section enables the setting of regional information, depending on the location of the **Aurora TransPort**.

To reset the regional settings, from the Settings Menu, select Locale ... and press **Enter**. The following screen appears.

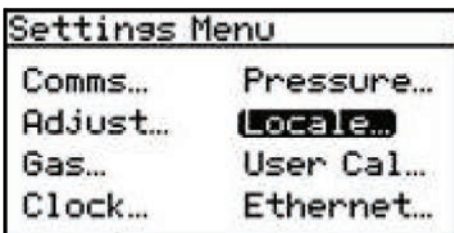

Note: Locale settings for your order have been set at the factory and are access code protected. If you determine a need to access Regional Settings, contact the factory for assistance.

4.7.1 Setting the country code

To edit the country code, from the Regional Settings Menu select Country Code and press **Enter**. The following screen appears. The User passcode (2719) is required to change the value.

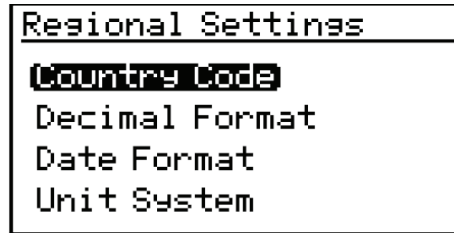

Use the left and right arrow keys to select each digit to be changed. Use the up and down arrow keys to change the value. When finished, press **Enter**. The screen returns to the Regional Settings Menu.

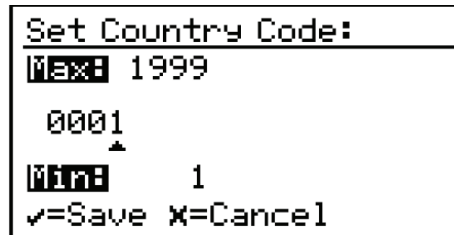

- **Country Codes** = international telephone country codes.
- **Default** = 1 for U.S.
- **Option**= 81 for Japan is available to conform to METI requirements.

4.7.2 Setting the decimal format

The Decimal Format option determines whether a decimal[.] or a comma[,] is used as the decimal separator. To edit the decimal format, from the Regional Settings Menu select Decimal Format and press **Enter**. The following screen appears.

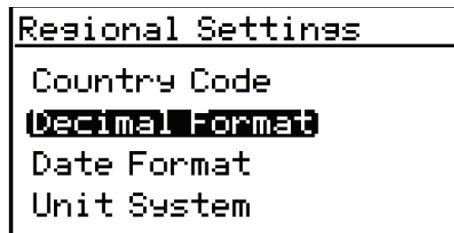

Use the left and right arrow keys to select a decimal [.] or a comma [,] as the decimal separator and press **Enter**. The screen returns to the Display Menu.

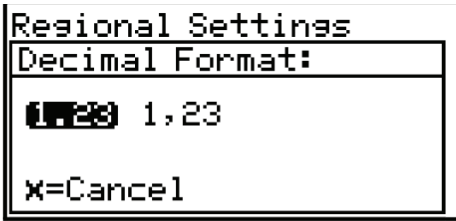

4.7.3 Setting the date format

To edit the date format, from the Regional Settings Menu select Date Format and press **Enter**. The following screen appears.

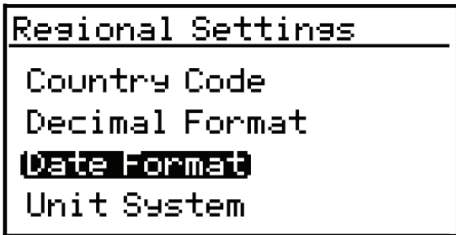

Use the left and right arrow keys to select the desired date format and press **Enter**. The screen returns to the previous display.

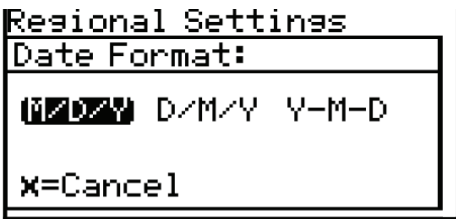

4.7.4 Setting the unit system

IMPORTANT:

If the Country Code (see "Setting the Country Code" on page 32) has been set to 81 (Japan) the Unit System menu is not available.

To select the unit system to be used for measurements, select Unit System and press **Enter**. The following screen appears.

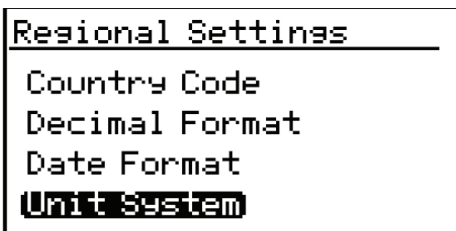

Use the left and right arrow keys to select the Unit System desired [SI= only metric units are available in the selection menus; SI + US = both metric and English units are available in the selection menus] and press **Enter**. The screen returns to the Regional Settings Menu.

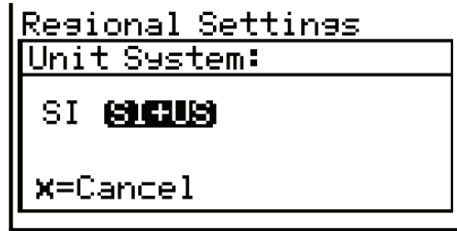

Note: Changing the Unit System setting from SI+US to SI in the above menu will **NOT** immediately change the current Display or Outputs units. This is because it is not possible for the **Aurora TransPort** to know the SI measurement units desired by the operator to replace any currently displayed or output English units. However, the next time the operator selects different Display (see "Selecting Primary Units" on page 11) or Outputs (see "Selecting Output Units" on page 13) units, only SI units will be available in the menu.

4.8 User calibration

The **Aurora TransPort** supports a two-point User Calibration for use in methane/natural gas. This is provided so that a field calibration can be easily performed to cause the **Aurora TransPort** measurement to correspond to a calibration gas or other moisture device. The User Calibration is independent from, and does not affect, the Factory Calibration. The **Aurora TransPort** can be quickly switched between User and Factory calibration at any time.

When a User Calibration is active, an asterisk (*) will appear in the upper left corner of the primary display.

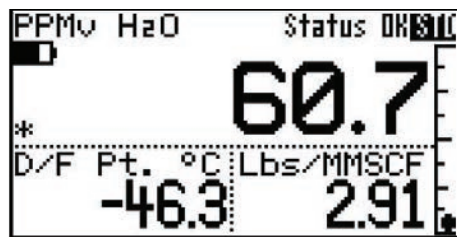

Before the calibration can be performed, the **Aurora TransPort** must be operating correctly in methane or natural gas, with methane selected as the Background Gas.

Choose Settings ... from the Main Menu. A User Cal. ... selection is now provided.

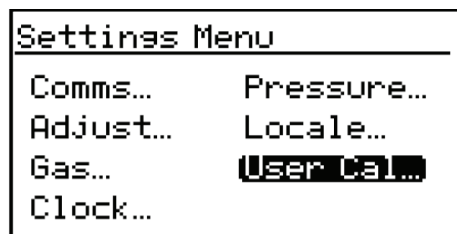

Note: If the **Aurora TransPort** is set for Nitrogen as the background gas, the User Cal selection will be disabled/grayed out.

The **Aurora TransPort** will prompt for the User Passcode [2719]

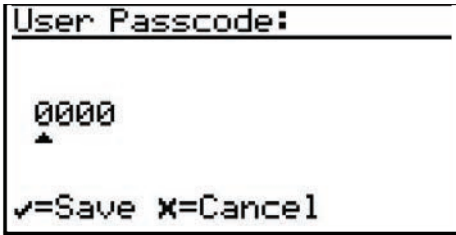

By default, the **Aurora TransPort** is operating with the Factory calibration, so the User Calibration Menu is disabled with the exception of the Status selection.

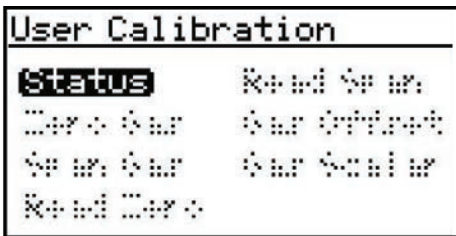

Select Status, and choose User as the Active Calibration.

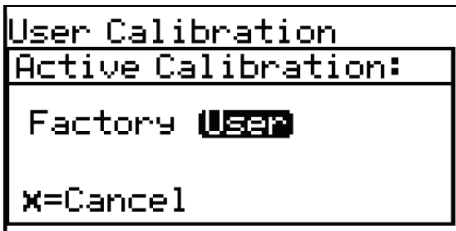

The User Calibration Menu is now enabled.

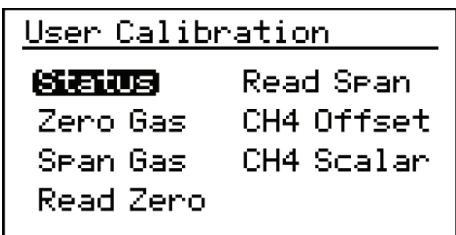

The selections on the User Calibration Menu include the following functions:

Item	Purpose
Zero Gas	User specifies the water concentration, in PPMv, of the "Zero", or dry gas.
Span Gas	User specifies the water concentration, in PPMv, of the "Span", or Cal/Wet gas.
Read Zero	The Aurora TransPort will read the signal while exposed to the Zero gas.
Read Span	The Aurora TransPort will read the signal while exposed to the Span gas, then determine the CH4 Offset and Scalar calibration values.
CH4 Offset	Permits the user to view/edit the calculated offset term.
CH4 Scalar	Permits the user to view/edit the calculated scalar (gain) term.

First select the Zero Gas and Span Gas items, to specify the cal gases to be used. The zero gas must be in the range of 0.0 to 50.0 PPMv water. It is recommended that the zero gas be 10.0 PPMv or higher for best results. The Span gas must be in the range of 0.0 to 5000.0 PPMv water. It is recommended that the Span gas be 500.0 PPMv or lower for best performance.

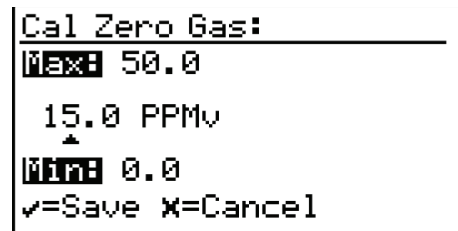

Apply the Zero gas, and wait for the **Aurora TransPort** reading to stabilize.

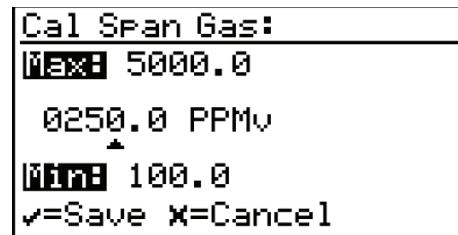

Note: The user can exit to the display and return to the User Cal Menu without affecting the Calibration procedure.

```

Read Zero Gas:
 19% Complete
  
```

When the reading is stable, select **Read Zero**. The **Aurora TransPort** performs multiple measurements for approximately 15 seconds, indicating its progress. When the readings are complete, you will be prompted to apply the span gas, and continue. If there is doubt about the stability of the zero gas, the reading can be repeated at this point.

```

Read Zero Gas:
 100% Complete

Apply 250 PPMv gas,
& select Read Span...
✓=Repeat ✗=Continue
  
```

Apply the Span gas, and wait for the **Aurora TransPort** reading to stabilize.

When the reading is stable, select Read Span. The **Aurora TransPort** uses the current measurement, and immediately calculates the new calibration. If the calculated values are determined to be valid, the **Aurora TransPort** will display "Calibration OK" and prompt you to Save the results, or Cancel. If the values are not valid, the Aurora will display "Calibration *FAILED*", and prompt you to continue. On a cal failure or Cancel, no change is made to the User Calibration values.

The CH4 Offset and CH4 Scalar items can be used to view or modify the calculated calibration points, if desired.

Note: The default values for the CH4 Offset is 0.0 and the CH4 Scalar is 1.0. These defaults are NOT the same as the Factory Calibration! Making the User Cal active without performing the actual calibration will adversely affect the accuracy of the **Aurora TransPort**. If there is any doubt about the quality/accuracy of the gases used, the **Aurora TransPort** should be returned to the Factory calibration using the Status item.

4.9 Service settings



CAUTION!

The Service Settings Menu should be used by factory-trained personnel only.

4.10 Aurora TransPort information

To check the **Aurora TransPort** information, from the Main Menu select About and press **Enter**. The following screen appears.

```

Main Menu
Display..  Service..
Outputs..  About...
Alarm...   Diass
Settings.. LOCK
  
```

4.10.1 Checking the ID

To check identification information, select ID and press **Enter**. A screen similar to the following appears.

```

About Aurora
ID
System Status
Software Versions
Gas Composition
  
```

To return to the About Menu, press **Enter**.

```

Menu:✗
GE Aurora TransPort
Copyright © 2008-18
General Electric Co.
Unit SN: 1425
Laser SN: 1417/14-7
  
```

4.10.2 Checking the system status

To view the status of the **Aurora TransPort** system, from the About Menu select System Status and press **Enter**. A screen similar to the following appears.

```
About Aurora
ID
System Status
Software Versions
Gas Composition
```

Uptime: is the elapsed time since the **Aurora TransPort** was powered on or reset.

Started: is the date and time that the **Aurora TransPort** was last powered on/reset.

Start Temp: is the laser housing temperature as measured at the last startup/reset.

Laser Hours: indicates the total lifetime that the laser has been energized.

To return to the About Menu, press **Enter**.

```
Menu:X
Uptime: 0d 03h
Started: 5/16/2018 11:06
Start Temp: 23.80 °C
Laser Hours: 1187
```

4.10.3 Checking the software

To view the software versions being used, from the About Menu select Software Versions and press **Enter**. A screen similar to the following appears.

```
About Aurora
ID
System Status
Software Versions
Gas Composition
```

To return to the About Menu, press **Enter**.

```
Menu:X
BOOT: 2.C
PROG: ATP.002.A
Prog CRC: 7c0f7375
```

4.10.4 Checking the gas composition

To view the gas content, from the About Menu select Gas Composition and press **Enter**. A screen similar to the following appears.

```
About Aurora
ID
System Status
Software Versions
Gas Composition
```

To return to the About Menu, press **Enter**.

```
Menu:X
Gas: STD
CH4: 90.0%
N2: 10.0%
```

4.10.5 Checking the alternate gas composition

The **Aurora TransPort** TDLAS is normally calibrated to a standard gas mixture that is representative of “typical” natural gas. The primary components and concentrations of this gas mixture are as follows:

Component	Concentration
Methane (CH ₄)	90.0%
Nitrogen (N ₂)	10.0%

For special applications, where the composition of the gas to be measured differs significantly from the standard, Panametrics can provide an alternate calibration. If this service has been ordered, the **Aurora TransPort** will be shipped from the factory with both the standard and a custom calibration installed.

The calibration in use can be verified at any time using the Aurora TransPort About... menu. From the Main Menu, select About and press Enter. The following screen appears.

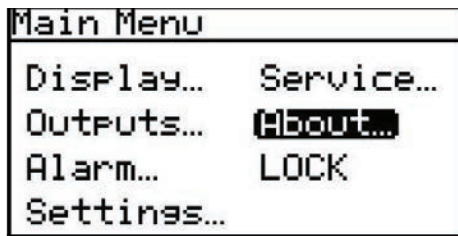

From the About Aurora menu, select Gas Composition and press Enter. The following screen appears.



An identifier label for the gas composition will be displayed above the components:

Gas Composition Identifier

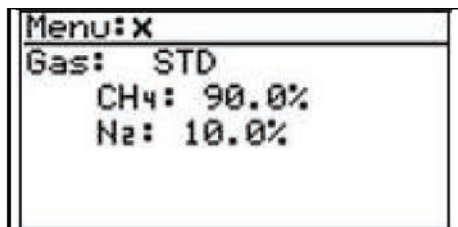

4.11 Locking/Unlocking the display

To lock the **Aurora TransPort** against any future changes, from the Main Menu select Lock and press **Enter**. The screen returns to the standard display.

Note: This menu option is the same as exiting the programming menu and waiting for a keypad time-out to lock the keypad.

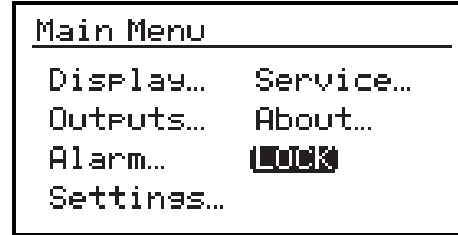

To unlock the **Aurora TransPort** for changes, press **Cancel**, **Enter**, **Cancel** as instructed in “Unlocking the Keypad” on page 10.

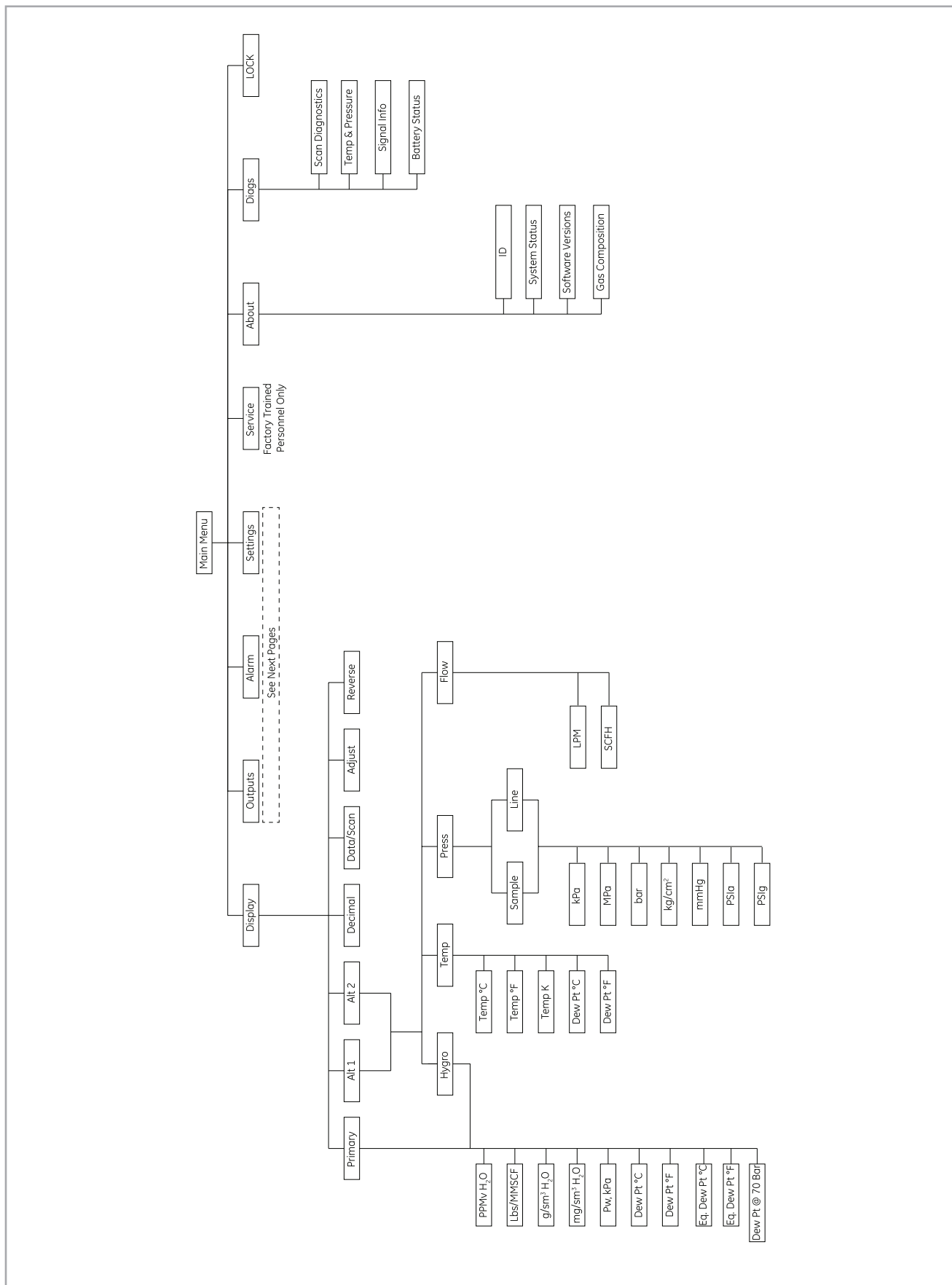

Figure 17: Display, about and diags menu map

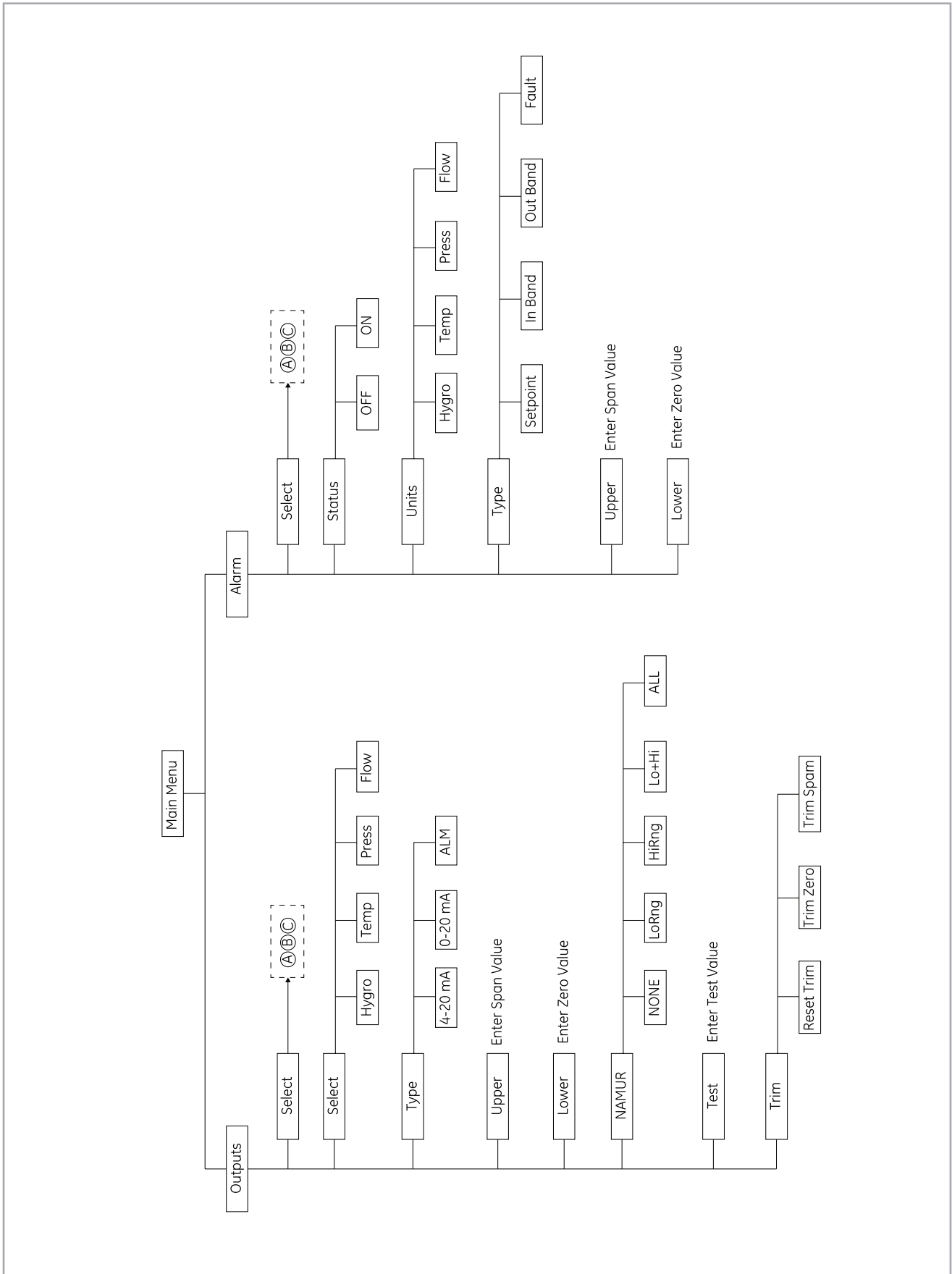

Figure 18: Outputs and alarm menu map

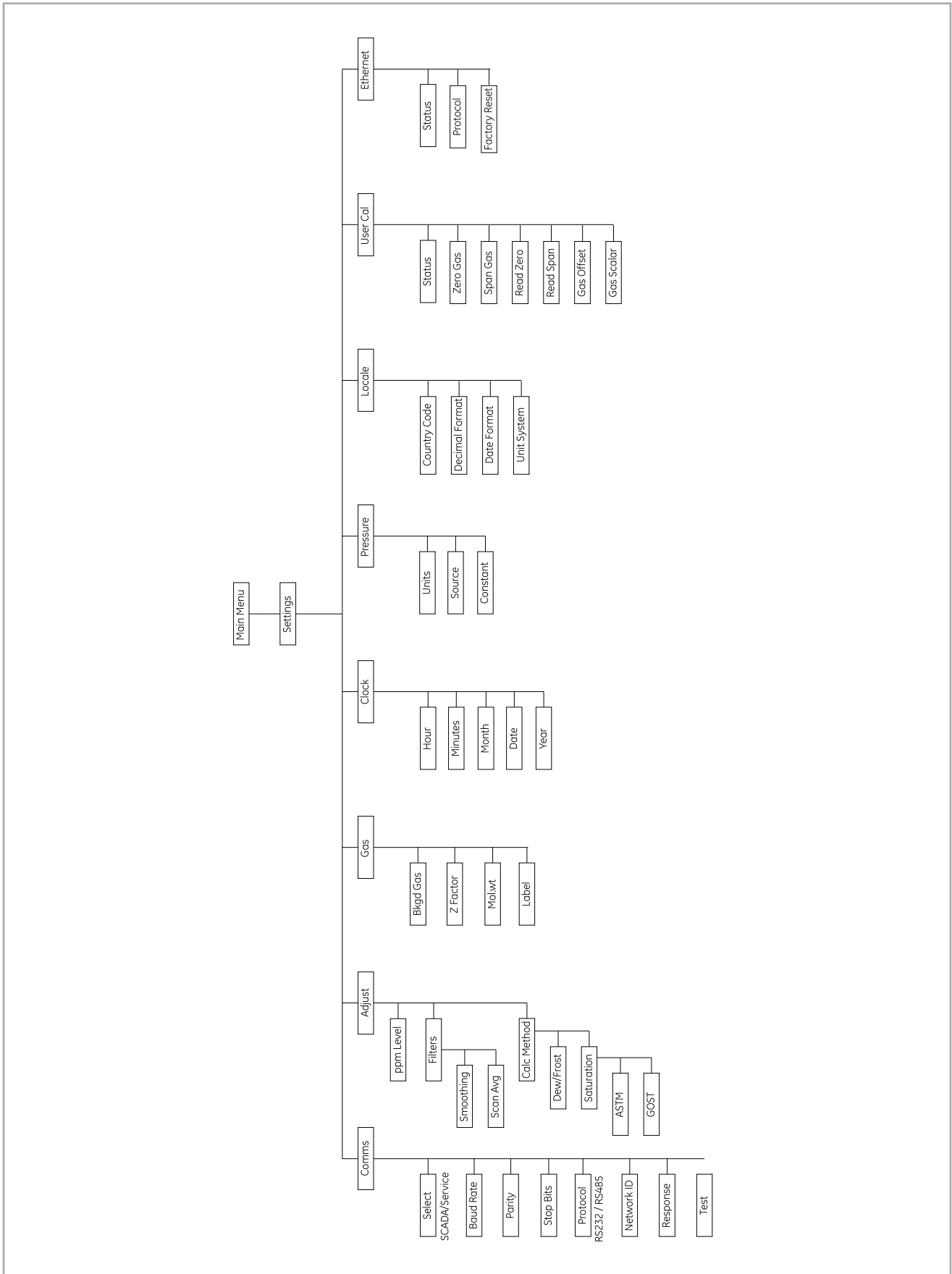

Figure 19: Settings menu map

[no content intended for this page]

Chapter 5. AuroraView interface software

5.1 Capabilities

Your **Aurora TransPort** Analyzer is shipped with a USB Flash Drive which includes a PC-Software Application called **AuroraView**. With **AuroraView**, you can:

- View **Aurora TransPort** Configuration Items such as Alarms and Outputs.
- Use the DataLog function to copy data to a comma delimited .txt file which can be opened by spreadsheet applications such as Microsoft Excel.
- Plot real-time data for one or more **Aurora TransPort** parameters
- Manipulate plotted data in a variety of ways such as: color, line type, zoom in/out, etc.
- Trend tabular data in real-time.
- Show Scan Plots of the moisture absorption spectra.
- Copy plots from **AuroraView** to other Window applications like Microsoft Powerpoint or Word.

AuroraView does not provide functionality for the following:

Aurora TransPort software updates.

Save the **Aurora TransPort** Configuration. The **Aurora TransPort** has a robust design which allows the meter to recover from fault conditions without the need to upload the configuration of the meter using external software.

5.2 Requirements

AuroraView leverages a *National Instruments Run-Time* environment. This environment is supported on the following operating systems with the minimum installation requirements indicated:

- Windows XP (SP3), Windows7, Windows 8.1 or Windows 10
- 260 MB of available hard disk space
- 64 MB of RAM or more
- 300 MHz Pentium CPU
- Internet Explorer vS.0 or higher

AuroraView supports the following serial interfaces:

- RS232
- RS485 Modbus
- Modbus/TCP via Ethernet

5.3 Installing AuroraView

1. Insert the Installation Flash Drive into the USB port on your PC.
2. The installation program should launch automatically (see *Figure 20* below). If it does not, select Start → Run → Browse.

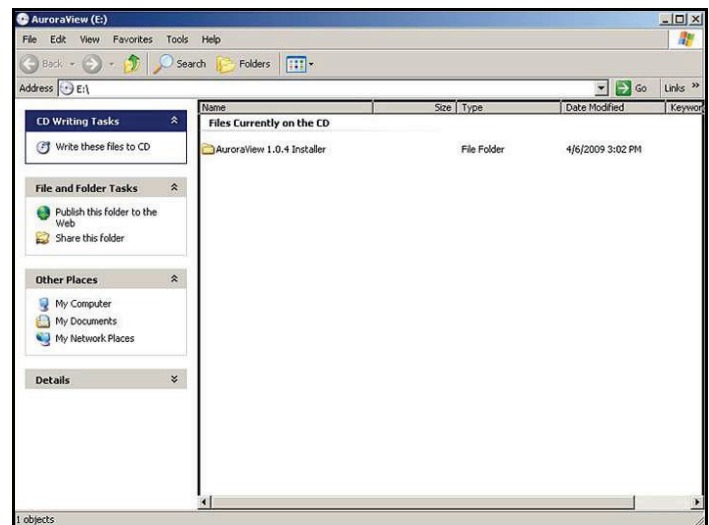

Figure 20: Initial screen

3. Browse to the file named "setup.exe" in the root directory of Aurora View (see *Figure 21* below). Double-click the file to start the installation.

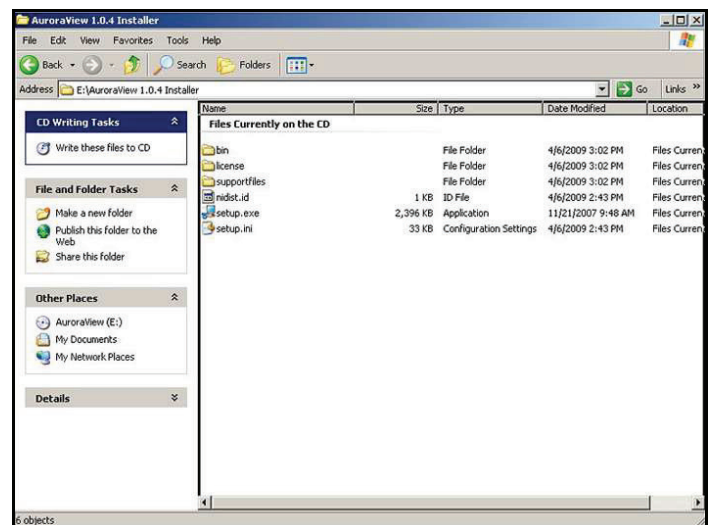

Figure 21: AuroraView installer

4. Exit all other programs before running the installer (see *Figure 22* below).

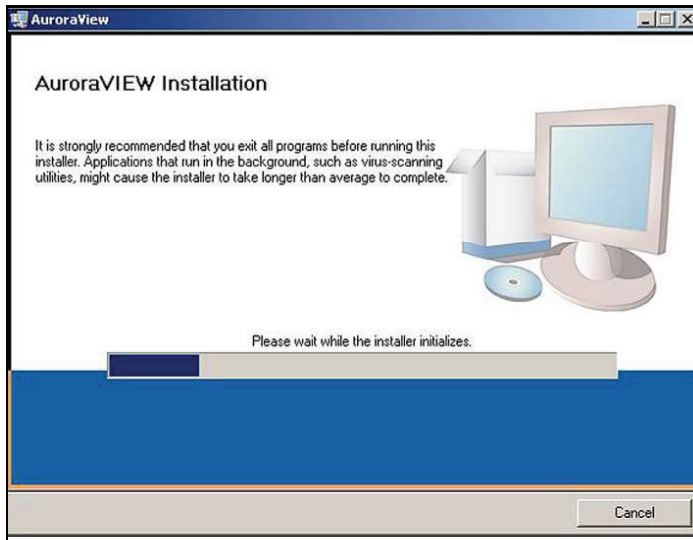

Figure 22: Installation recommendation

5. The next screen (see *Figure 23* below) provides the opportunity to change installation locations if desired. When ready, click **Next**.

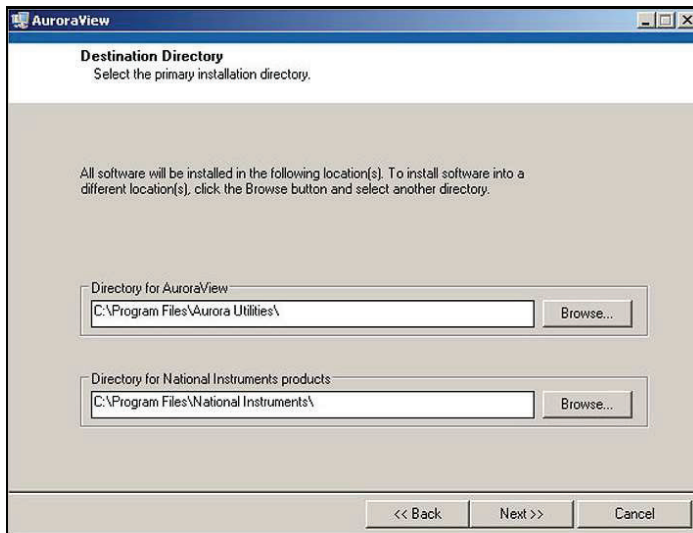

Figure 23: Destination directory

6. At the next screen, accept the *Software License Agreement* (see *Figure 24* below) and click **Next**.

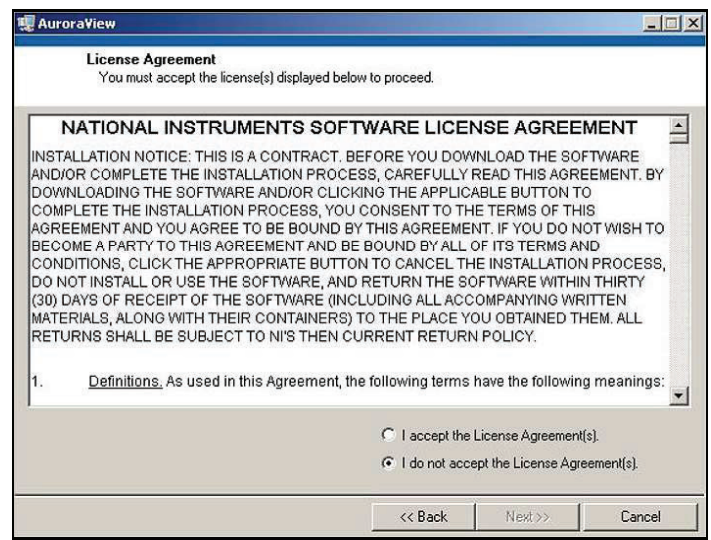

Figure 24: Software license agreement

7. The next screen (see *Figure 25* below) provides instructions for initiating the installation. When ready, click **Next** to begin.

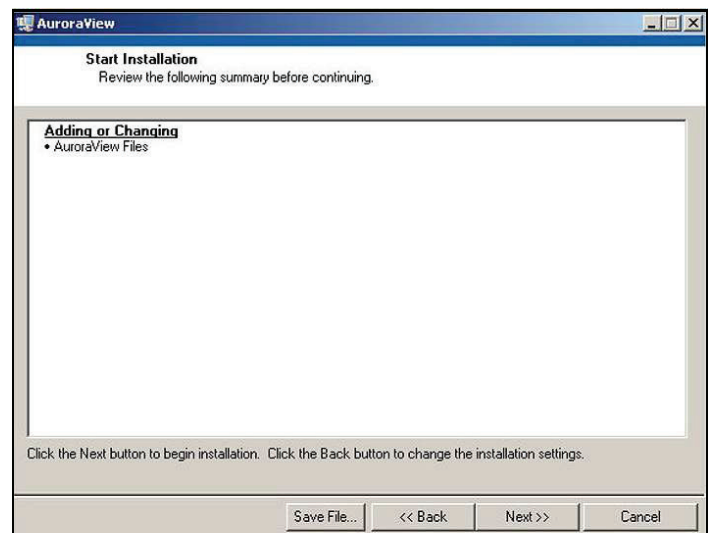

Figure 25: Starting the installation

8. During installation, the screen shown in *Figure 26* below appears.

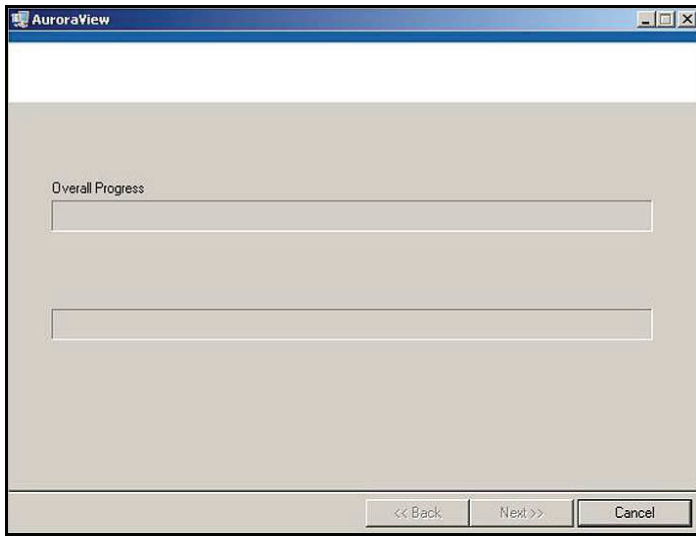

Figure 26: Overall progress

9. The screen shown in *Figure 27* below appears when the installation is complete.

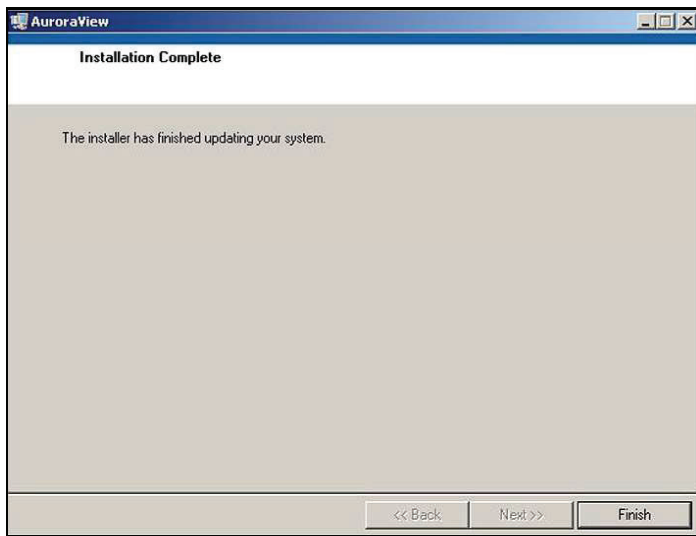

Figure 27: Installation is complete

5.4 Starting AuroraView

1. From the Start menu, click Programs → AuroraView → AuroraView (see *Figure 28* below).

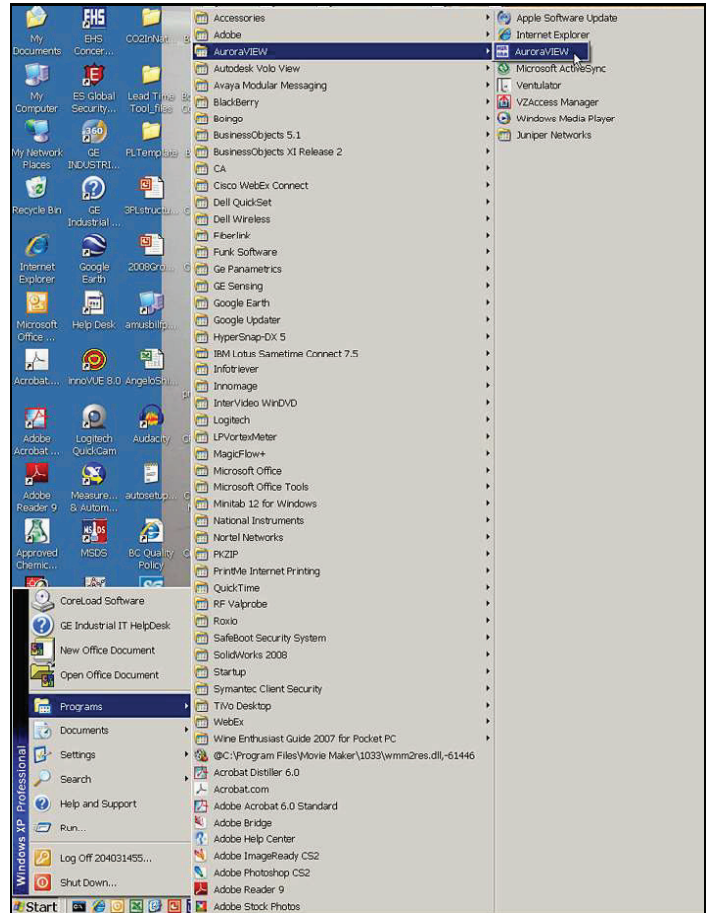

Figure 28: AuroraView in programs menu

2. AuroraView boots up and displays a screen similar to *Figure 29* below.

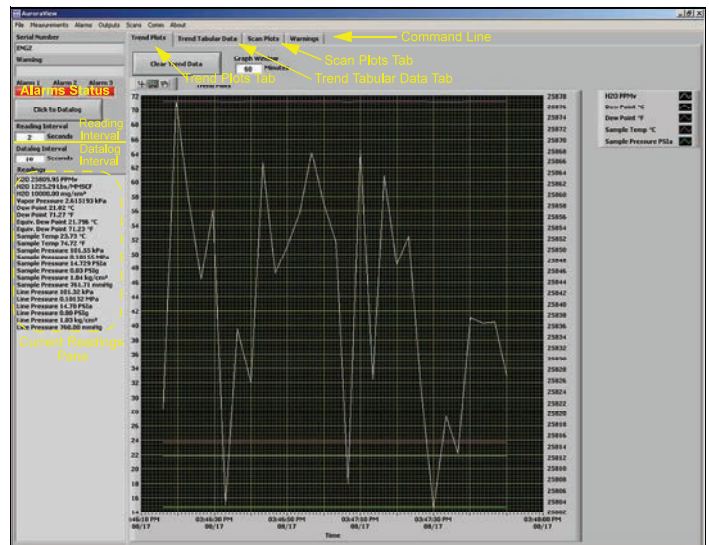

Figure 29: AuroraView main screen

5.5 Using the main menus

1. Click Measurements → Config (see Figure 30 below).

Measurement	Displayed As	Unit String	Digits Of Precision	Read	Plot	Datalog	Use Second Axis
Volume_Ratio_PPMv	Volume Ratio	PPMv	1	<input checked="" type="checkbox"/>	<input checked="" type="checkbox"/>	<input checked="" type="checkbox"/>	<input checked="" type="checkbox"/>
Dew_Point_C	Dew Point	°C	1	<input checked="" type="checkbox"/>	<input type="checkbox"/>	<input checked="" type="checkbox"/>	<input type="checkbox"/>
Eq_Dew_Point_C	Equiv. Dew Point	°C	1	<input checked="" type="checkbox"/>	<input type="checkbox"/>	<input checked="" type="checkbox"/>	<input type="checkbox"/>
Abs_Humidity_mg_m3	Abs. Humidity	mg/sm ³	2	<input checked="" type="checkbox"/>	<input type="checkbox"/>	<input checked="" type="checkbox"/>	<input type="checkbox"/>
Volume_Ratio_PPBv	Volume Ratio	PPBv	0	<input type="checkbox"/>	<input type="checkbox"/>	<input type="checkbox"/>	<input checked="" type="checkbox"/>
Abs_Humidity_g_m3	Abs. Humidity	g/sm ³	2	<input type="checkbox"/>	<input type="checkbox"/>	<input type="checkbox"/>	<input type="checkbox"/>
Abs_Humidity_kg_m3	Abs. Humidity	kg/sm ³	2	<input type="checkbox"/>	<input type="checkbox"/>	<input type="checkbox"/>	<input type="checkbox"/>
Abs_Humidity_Lbs_MMSCF	Abs. Humidity	Lbs/MMSCF	2	<input checked="" type="checkbox"/>	<input type="checkbox"/>	<input checked="" type="checkbox"/>	<input type="checkbox"/>
Pw_kPa	Vapor Pressure	kPa	6	<input checked="" type="checkbox"/>	<input type="checkbox"/>	<input checked="" type="checkbox"/>	<input type="checkbox"/>
Dew_Point_F	Dew Point	°F	1	<input type="checkbox"/>	<input type="checkbox"/>	<input type="checkbox"/>	<input type="checkbox"/>
Eq_Dew_Point_F	Equiv. Dew Point	°F	1	<input type="checkbox"/>	<input type="checkbox"/>	<input type="checkbox"/>	<input type="checkbox"/>
Eq_Dew_Point_70_bar_C	Dew Point @ 70 bar	°C	1	<input type="checkbox"/>	<input type="checkbox"/>	<input type="checkbox"/>	<input type="checkbox"/>

Figure 30: Configure measurements screen

- Unit String: Set this value to the value you want to read, plot or datalog.
- Digits of Precision: Set a numerical value (typically 0, 1, 2). This sets the resolution of the displayed measurement units to the right of the decimal place (i.e., "20.78" would result from a setting of "2").
- Read: Check this box if you want to show the value in the current Readings pane.
- Plot: Check this box if you want to show the value in the Trend Plots graph AND the Trend Tabular Data tab

2. Click Alarms → Config

This window enables the user to configure the alarm status within the **AuroraView** application. This feature allows you to remotely configure **Aurora TransPort** alarms, which are used only with Modbus RTU digital output. The **AuroraView** Alarms are shown in *Figure 31*, *Figure 32*, and *Figure 33* below.



Figure 31: Alarms configuration

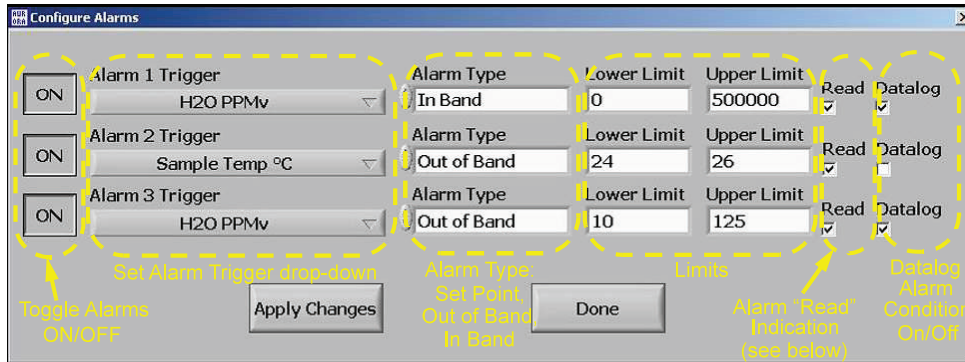

Figure 32: Other measurements options



Figure 33: Alarm status indicators

3. Click Outputs → Config (see *Figure 34* and *Figure 35* below).



Figure 34: Outputs configuration

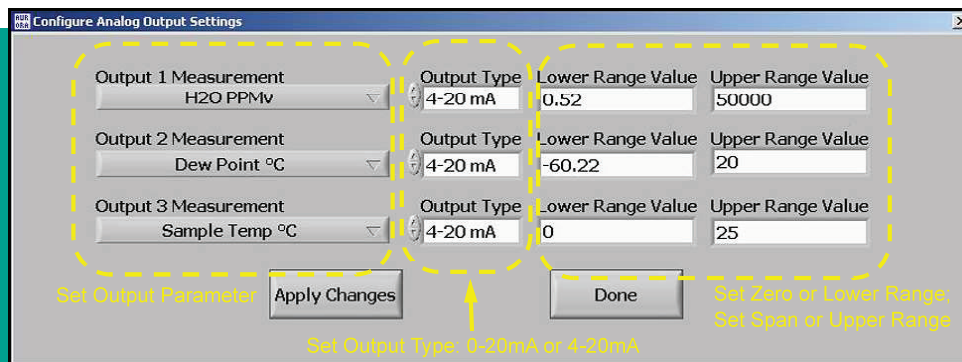

Figure 35: Other output options

4. Click Sean

This section enables you to pick the desired type of scan. The default scan is the SPECTRA scan, which shows the 2f spectral scan. This is the processed signal waveform that the **Aurora TransPort** uses to determine the moisture concentration. Viewing this scan may assist in troubleshooting. A typical 2f spectra scan is shown in *Figure 37* below. Select the scan interval in minutes to set the refresh rate at which **AuroraView** updates the scan plot. To enter a scan interval, click on the Click to Save Scans Periodically button, and the screen shown in *Figure 36* below appears. Enter the interval and click on Continue to save or Cancel to reject the change.

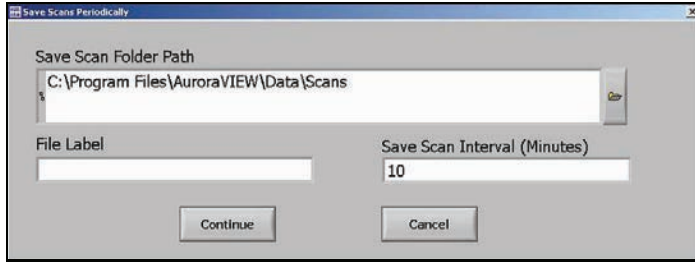

Figure 36: Save scans periodically

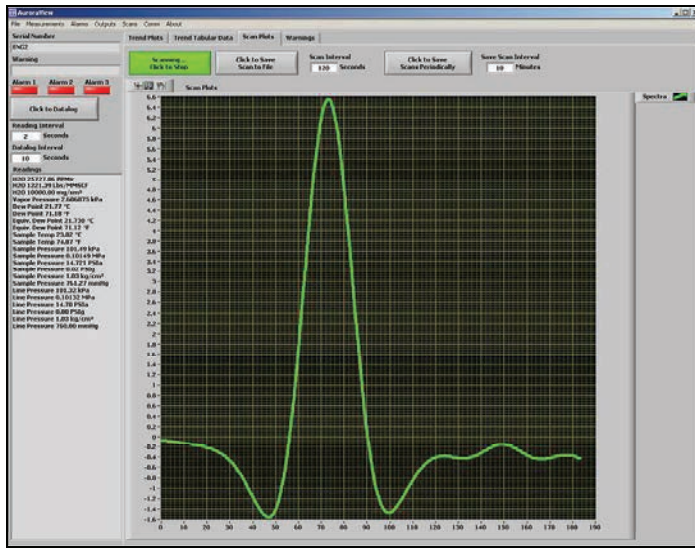

Figure 37: Scan plot tab

5. Click Comms

This window (see *Figure 38* below) enables you to configure communication options. Communication with the Aurora takes place over a serial ('comm') port, or via Modbus/TCP over Ethernet if the Aurora is so equipped. Choose the preferred method to use from the Modbus Interface drop down menu:

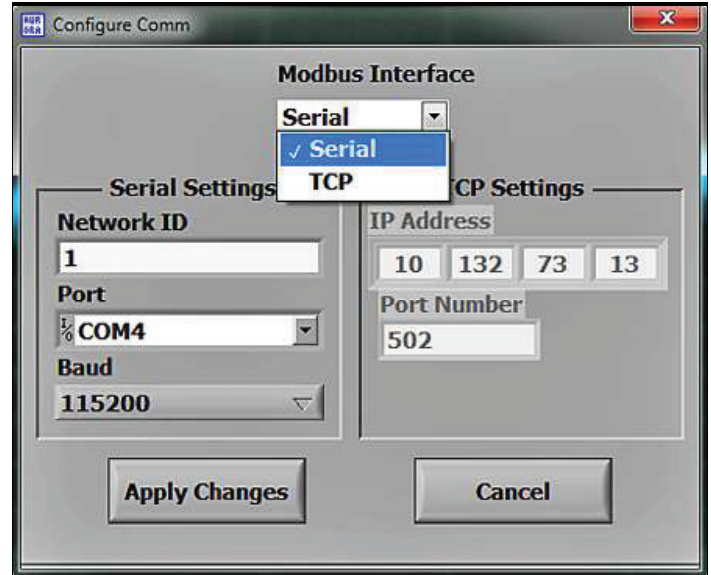

Figure 38: Configure communication options

For **Serial** (see *Figure 39* below), choose the comm port to use from the list of available ports. By default, AuroraView specifies 115200 bps, 8 data bits, even parity, and 1 stop-bit, which is also the default in the Aurora. If you have more than one Aurora TransPort on an RS485 network, you will have to establish a different **NETWORK ID** for each analyzer, using the keypad on the Aurora TransPort.

For **TCP** (see *Figure 39* below), specify the IP address of the Aurora, as described in "IP Address Assignment" on page 25. Unless required by your network infrastructure, do not change the Ethernet Port value from the default of 502.

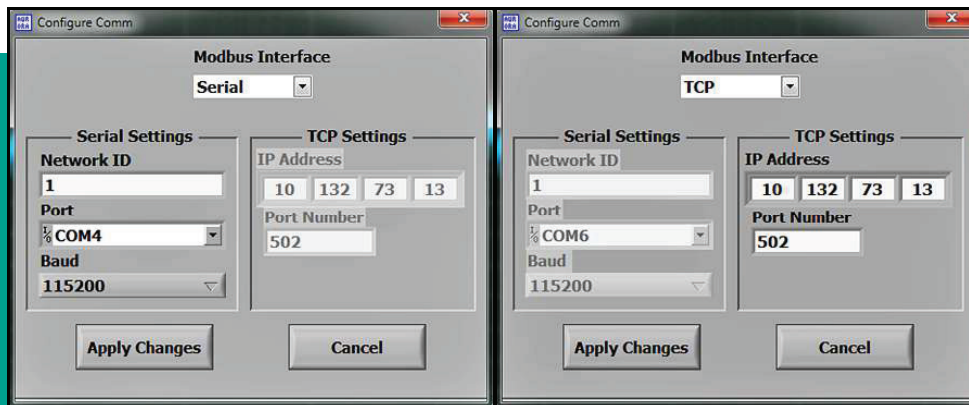

Figure 39: Serial (Left) and TCP (Right) screens

6. Click Help (see Figure 40 below).

This screen indicates the version of **AuroraView** currently installed.

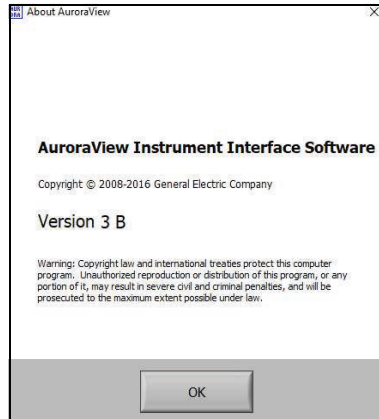

Figure 40: Software information

5.6 Datalogging with AuroraView

1. In the main view (see Figure 41 below), click on the button Click to Datalog.

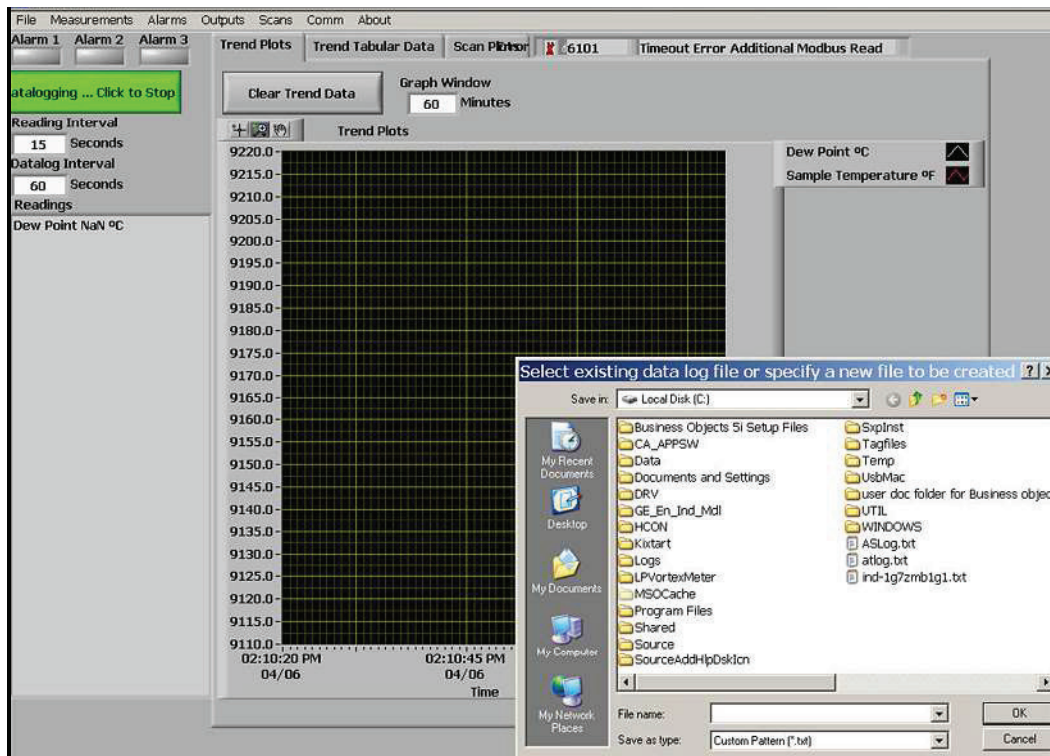

Figure 41: Datalogging with Aurora View

2. **AuroraView** will request a file location. Pick a file location and a file name to save your data log file. All data log files are comma delimited .txt files by default.
3. Once you pick a file location, **AuroraView** will write any parameter that has a check box with Data log checked in the main Config window at the time interval set in the Datalog Interval box, and the button in the main window will change to Datalogging ... Click to Stop.
4. When you are done datalogging, click the button to stop logging. You may now open your .txt datalog file in any application, such as Microsoft Excel, so that you can analyze that data.

Note: When datalogging multiple parameters at intervals of five seconds or less, it is recommended to use baud rates of 57.6K or 115.2K.

5.7 Working with trend plots, trend tabular data and scan plots

1. Trend Plots is a powerful graphing feature in AuroraView. You can graph many parameters at the same time (see *Figure 42* below).

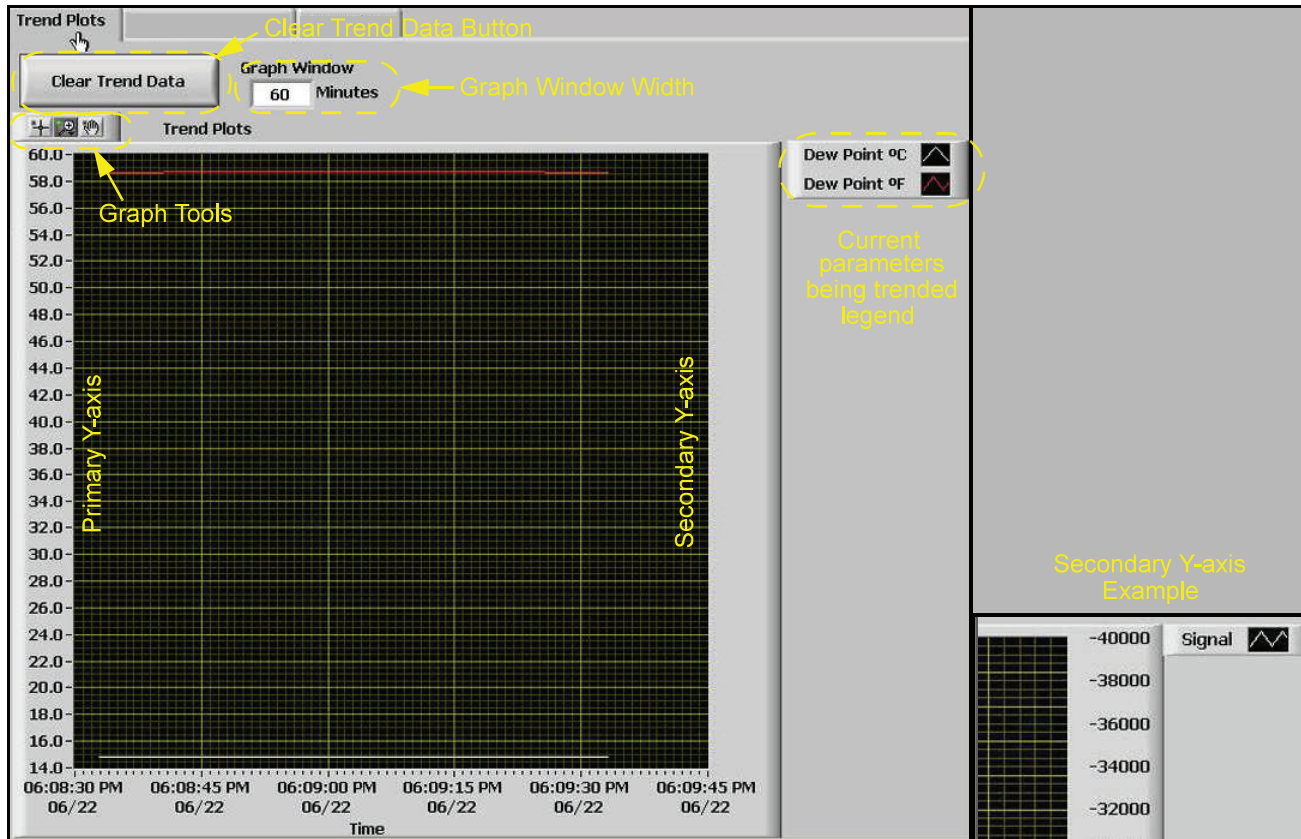

Figure 42: Using trend plots

Note: If you use the secondary y-axis, you may see “-” tick marks preceding the value. These are tick marks from the graphical applet and not an indication of negative values.

2. If you right-click on any series of data within the graph, or you click on the current parameter being-trended item in the legend, you will see a variety of options for graphing data (see Figure 43 below). You can change to a variety of common plots and adjust color, line style, and line width. For some data sets with lots of finite points, you may want to click Anti-Aliased which will smooth the plot line. You can also change bar plots, fill base line, interpolation and point style. X-Scale adjusts the x-scale. Y-Scale adjusts the y-scale and enables the secondary y-axis.

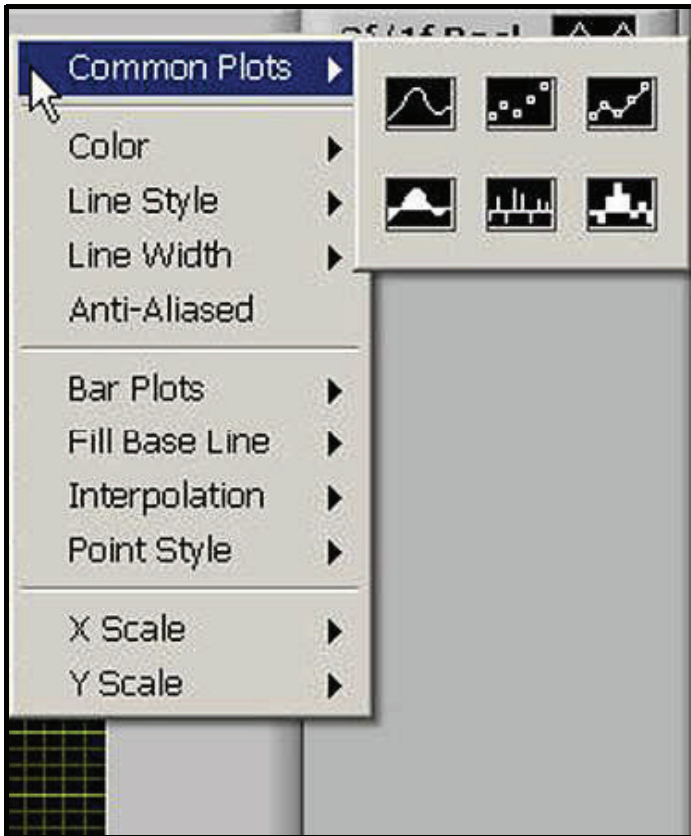

Figure 43: Options for graphing data

3. There is a series of Graph Tools available at the top left of the trend plot area (see Figure 44 below).

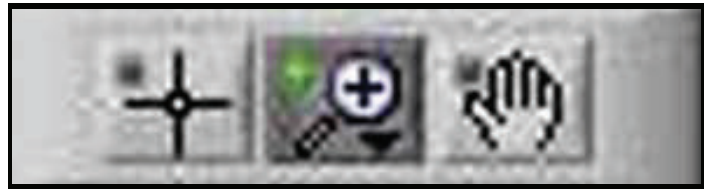

Figure 44: Graph tools

- Pointer
- Zoom Tool - gives you six options as shown in Figure 45 below.
- Hand Tool - Enables you to graph the trend plot area and move it around without rescaling.

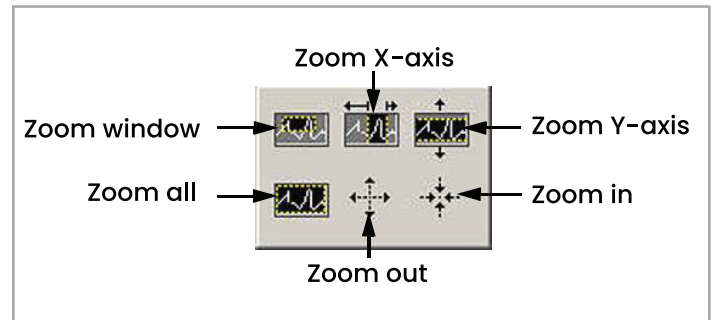

Figure 45: Zoom tool

- Copying and Pasting a Trend Plot can be done from **AuroraView** (see *Figure 46* and *Figure 47* below) One way to do this quickly is to simply right click over the data area and choose Copy. In another application, like Microsoft Word, simply paste.

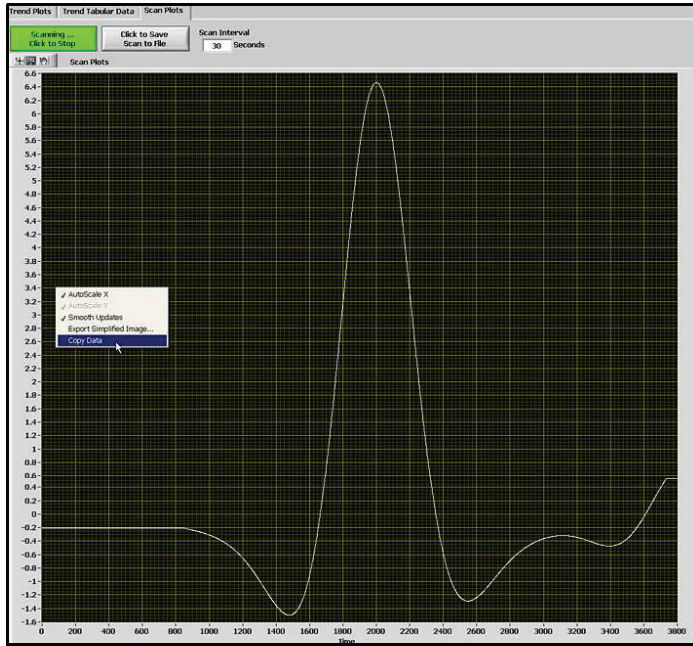

Figure 46: Copying a trend plot

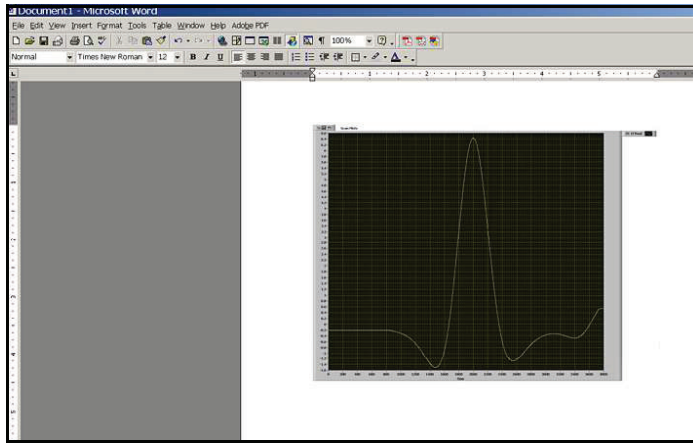

Figure 47: Pasting a trend plot

Another option is to right-click and chose the option Export Simplified Image (see *Figure 48* below). When you do this, a variety of image file formats will appear. A good universal option is Enhanced Metafile (see *Figure 49* on page 51). Pasting an enhanced metafile will give you the ability to paste an image with an inverted color scheme as shown in the second example posted into Word (see *Figure 50* on page 52).

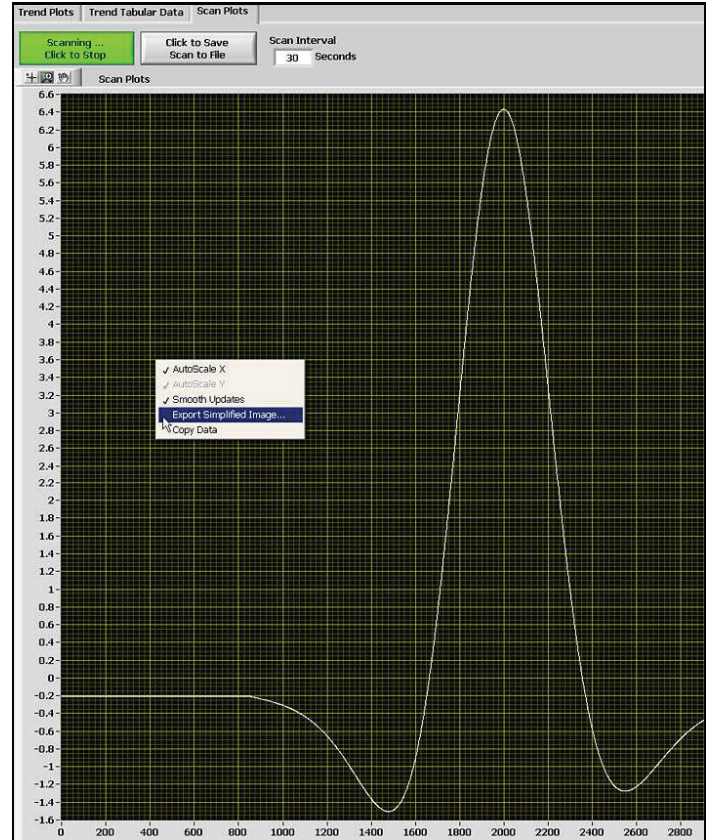

Figure 48: Exporting a simplified image

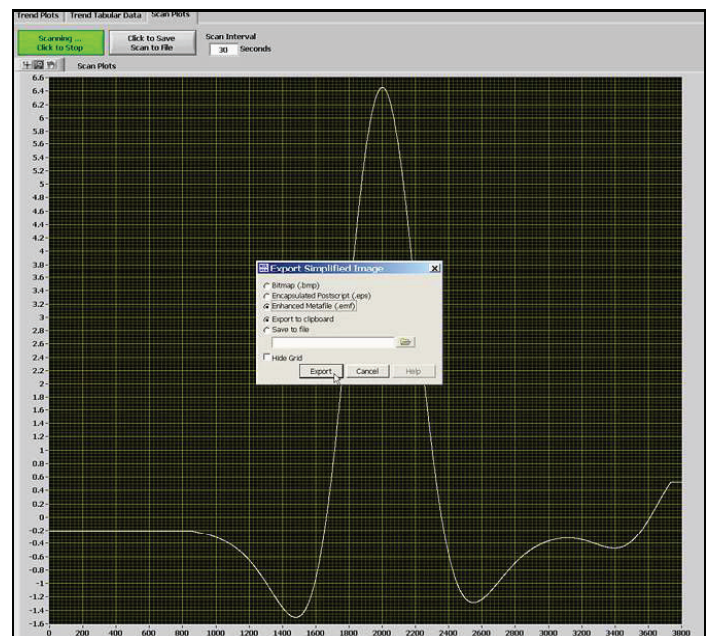

Figure 49: Selecting enhanced metafile

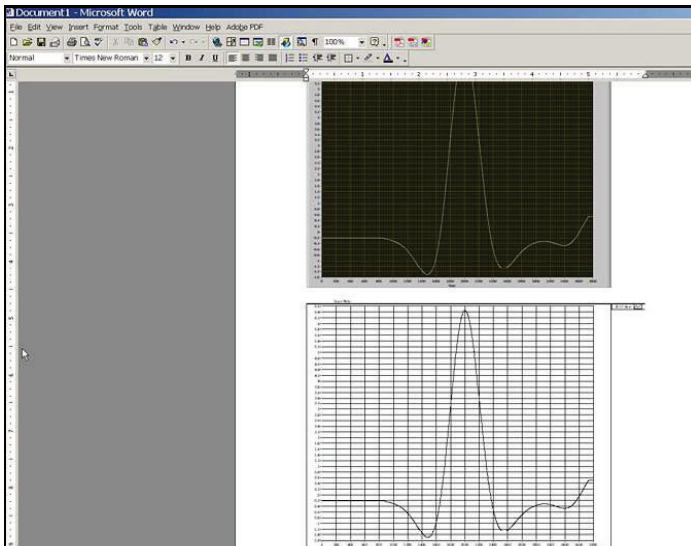

Figure 50: Pasting an enhanced metafile

Working with Trend Tabular Data, you will be able to see data in tabular format as shown in *Figure 51* below. You can adjust column widths to see data more easily with full titles in the header row.

System Time	Dew Point	Dew Point F
6:10:03 PM	14.84	58.71
6:09:48 PM	14.82	58.68
6:09:33 PM	14.81	58.67
6:09:18 PM	14.83	58.70
6:09:03 PM	14.85	58.73
6:08:48 PM	14.83	58.69
6:08:32 PM	14.81	58.67

Figure 51: Trend data in tabular format

Chapter 6. Maintenance



CAUTION!

Class 1m invisible laser radiation when open. Do not view directly with optical instruments.



WARNING!

Use of controls or adjustments or performance of procedures other than those specified herein may result in radiation exposure that is more hazardous than specified.

6.1 Spare parts

Table 3: Aurora TransPort spare parts list

Part No.	Description	Qty.
129M2285	24V, 120 WAC/DC power supply	1
200-304-LF	200-304-LF Li-ion smart battery pack, 14.40 V, 6.60 AH	1
130M1441	Aurora Mirror replacement assembly	1
130M5430	Aurora TransPort Remote I/O Cable	1
130M6684	Aurora TransPort desktop battery charger	1

Aurora TransPort maintenance kit

441-209	Plastic Case with Foam Inserts	1
240-199	Air Blower	1
403-161	Lens Tissue Package	1
463-030	Replacement Membrane Filter Elements	5
403-163	Nitrile Gloves	4
415-149	Graduated 3.9 ml plastic pipette	2

6.2 Cleaning the mirror

The **Aurora TransPort** analyzer may indicate a warning message **Weak Signal Return - Check Mirror** on the top line of the display, along with the red light "!" to the left of the main display. If this occurs, the mirror and/or the optical window of the measuring cell may be contaminated due to liquid or particulate coating/deposition.

Note: Reagent grade Acetone (Cas no. 67-64-1) may be needed for the cleaning process. The reagent is not supplied as part of the Aurora maintenance kit, and you must obtain the reagent from a local chemical supplier.

If the error condition **Check Mirror** is indicated, the first step is to clean the mirror. The process is as follows:

- Shut down the gas flow through the optical absorption cell.
 - Turn the inlet isolation needle valve to the closed position.
 - Ensure that the sample flow indicator indicates zero flow.
- Power down the **Aurora TransPort**.



CAUTION!

Class 1m invisible laser radiation when open. Do not view directly with optical instruments.



WARNING!

Use of controls or adjustments or performance of procedures other than those specified herein may result in radiation exposure that is more hazardous than specified.

- Wear a pair of disposable static dissipative Latex or Nitrile (powder free) gloves.

- Using the top panel Velcro handles, firmly lift the foam block assembly housing the absorption cell completely out of the Aurora TransPort Pelican case. As shown in Figure 52 below, this process may require holding down the Pelican case from the side. Place the extracted foam assembly on a flat surface with the slotted opening in the side of the foam layers clearly visible on the battery side of the front panel.

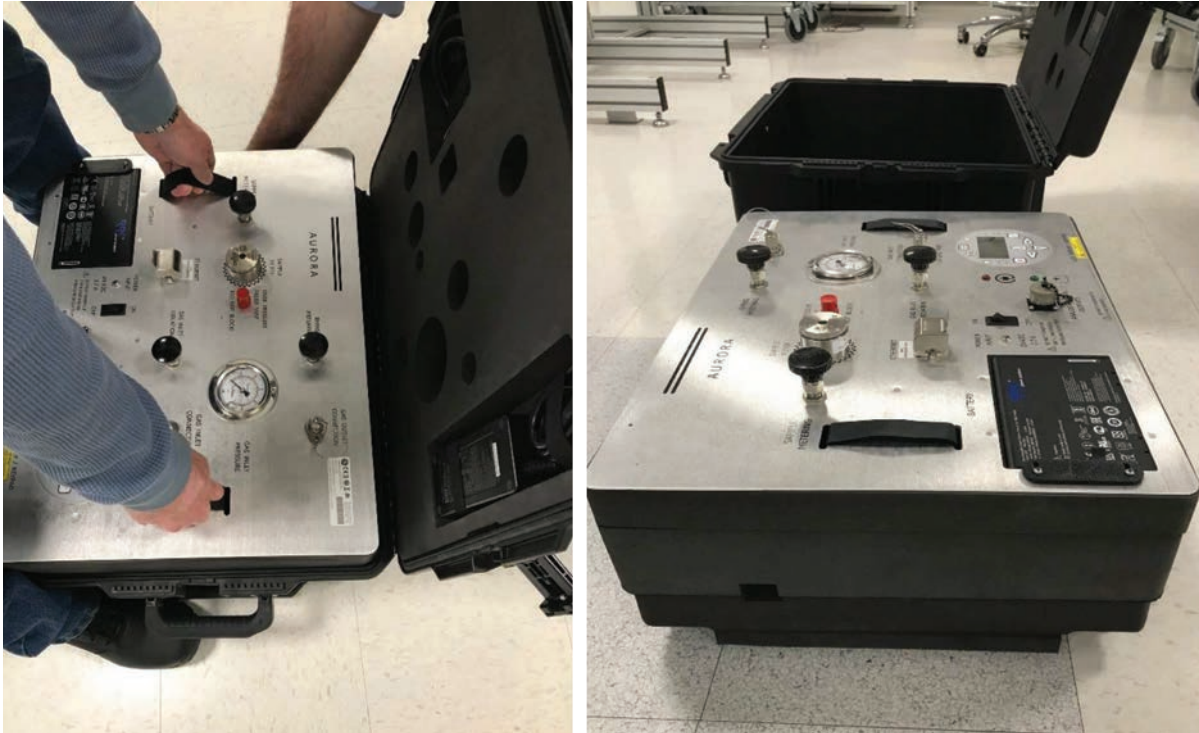

Figure 52: Extraction of inner foam assembly from TransPort Pelican case for access to absorption cell end mirror

- Once the inner foam assembly has been extracted from the Pelican case, the end mirror can be extracted using a 5/8" socket wrench. As shown in Figure 53 below, care should be taken to tip the entire foam assembly on its side where the mirror is located in order to hold the mirror end cap assembly in the socket wrench during and after extraction. Please note the mirror is not held in the end cap by epoxy, so proper care should be taken to avoid dropping the mirror out of the assembly during extraction and/or re-installation.



Figure 53: Extraction of absorption cell end mirror from inner foam housing while holding the assembly upright to prevent the mirror from falling out

- Using a $5/8$ " socket wrench to loosen the hex head of the mirror assembly, gently unscrew the mirror assembly from the bottom of the absorption cell. While *Figure 54* below shows this procedure for a dismantled cell, it is **NOT** necessary to dismantle the optical absorption cell assembly to remove the mirror.
- Due to its soft gold coating, this mirror can stick to the bottom of the cell when the end cap is removed. This can cause the mirror to become detached from the end-cap. To prevent this, tilt the foam block at an approximately 45° angle, so the foam block opening is facing downward. The mirror should be gently removed by pulling it straight down.

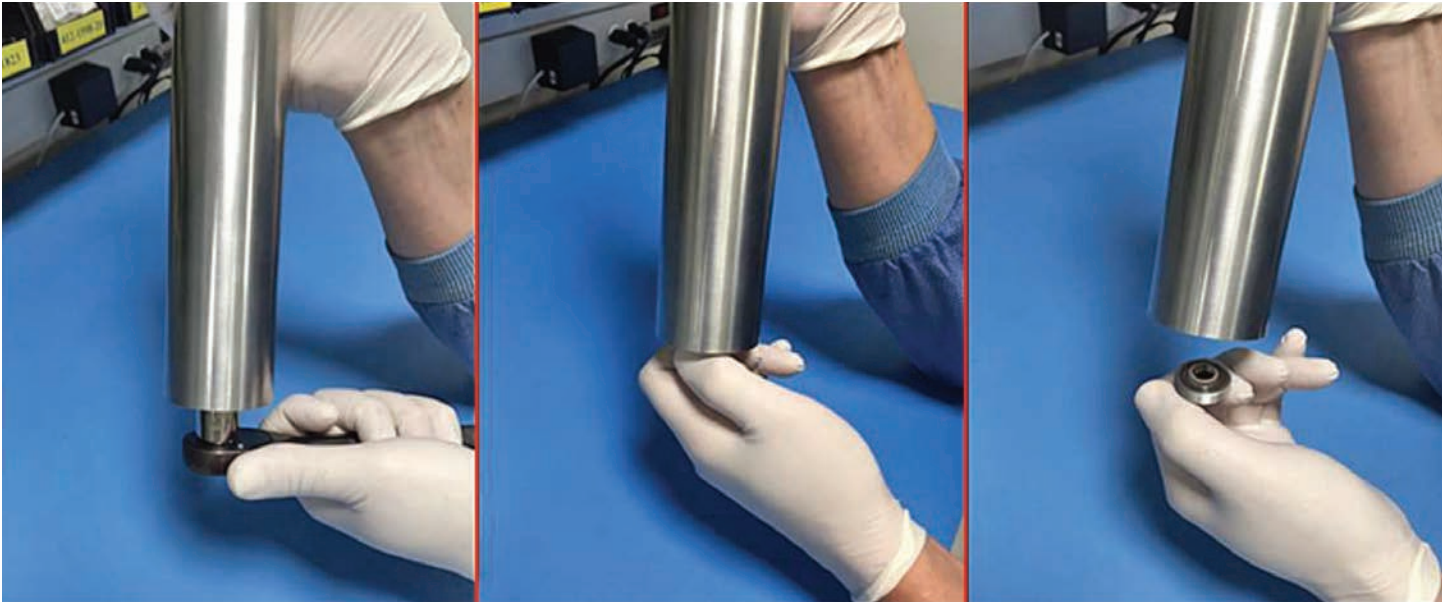

Figure 54: Removing mirror end cap assembly from the absorption cell



CAUTION!

Handle the mirror assembly with extreme care. Performance of the analyzer is critically dependent upon the mirror integrity. Do not touch the mirror surface with any tools, objects, hands or fingers.

- Gently place the extracted mirror assembly on a clean lens tissue. Using a pair of plastic-tipped tweezers gently extract the 0.5" diameter mirror from the end cap, taking care not to touch, squeeze or nick the two O-rings in the end cap assembly (see *Figure 55* below).

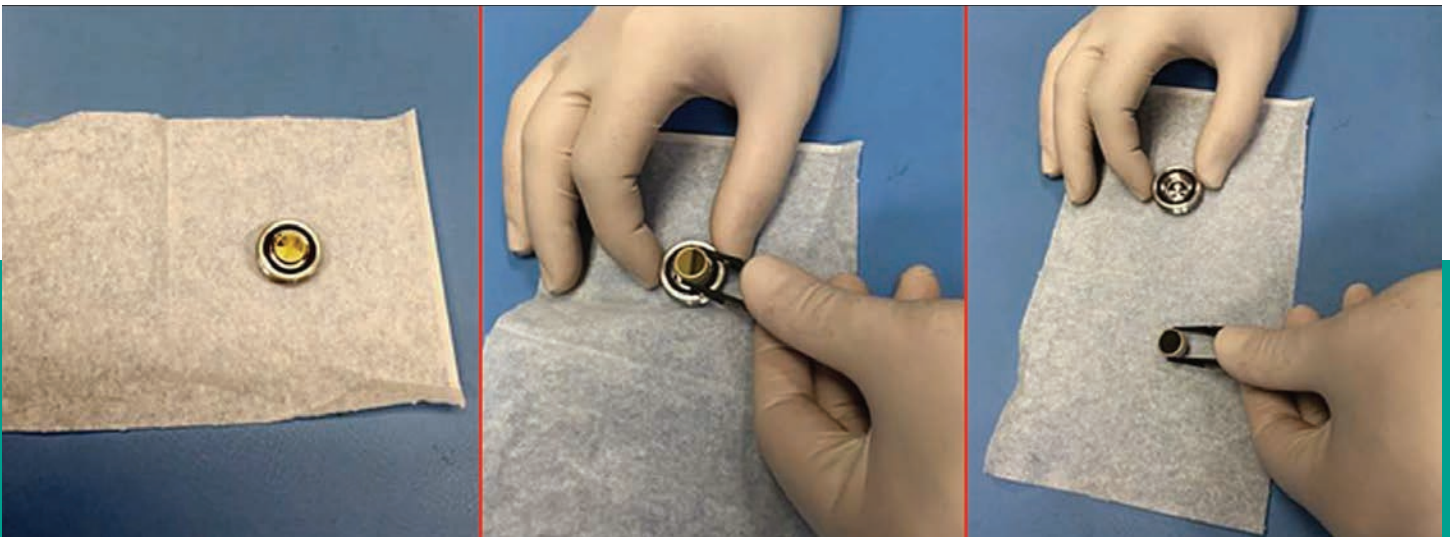

Figure 55: Inspecting the mirror assembly

9. Make a visual inspection of the mirror surface, and record any observations of gross contamination. If the mirror appears to be clean, do not clean it. Instead, reinstall it carefully into the system (go to Step 12).
10. If the mirror is contaminated, the first step in cleaning it is to use the air blower to blow away any particulate matter on the mirror surface. Place the mirror on a flat surface holding it from the sides with a pair of plastic tipped tweezers and repeatedly puff the air blower to force dry clean air onto the mirror surface.
11. Using a piece of lens tissue, wet a small area with a very small amount of analytical grade acetone (barely wetting the lens tissue). Typically, one drop of acetone will suffice. Tilt the lens tissue so that the acetone drop is absorbed by the lens paper along the length of the piece (see *Figure 56* below).



Figure 56: Applying acetone to lens tissue

12. Place the wet lens tissue on top of the mirror and drag it horizontally across the surface of the mirror, while holding it on with a pair of plastic-tipped tweezers (see *Figure 57* below). Ensure that minimal liquid residue or streaks are left behind on the mirror surface.

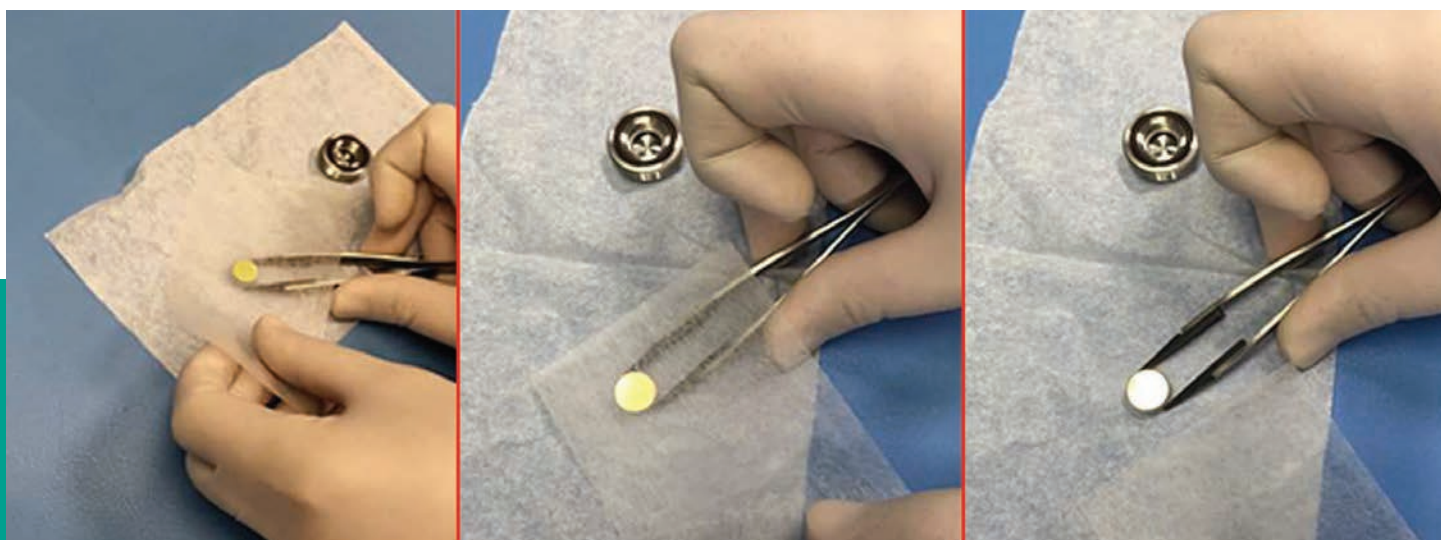

Figure 57: Cleaning a contaminated mirror

13. Use the air blower to blow dry air onto the surface of the mirror while holding it with the tweezers. Puff repeatedly until the mirror surface appears dry.
14. Repeat **Steps 6-8** above at least three times, using a new lens tissue each time. Each lens tissue wetted with acetone is used only once to clean off any visible residue on the mirror surface.
15. Visually inspect the mirror, and record any observation of residual contamination.
16. If the mirror does **NOT** appear clean after repeated cleaning, contact Panametrics Technical Support for further assistance.
17. If the mirror does appear to be clean, replace it into the mirror end cap, taking care not to disturb the two O-rings in the assembly (see Figure 58 below), Prepare to re-install the mirror end cap assembly into the optical absorption cell.



Figure 58: Replacing cleaned mirror into end cap assembly

18. Using tweezers, insert the mirror into the hole on top of the shim, with the gold-plated side facing up. Thread the end cap into the bottom of the absorption cell tube. Secure the threaded end cap in place with a 5/8" socket wrench (see Figure 59 below).

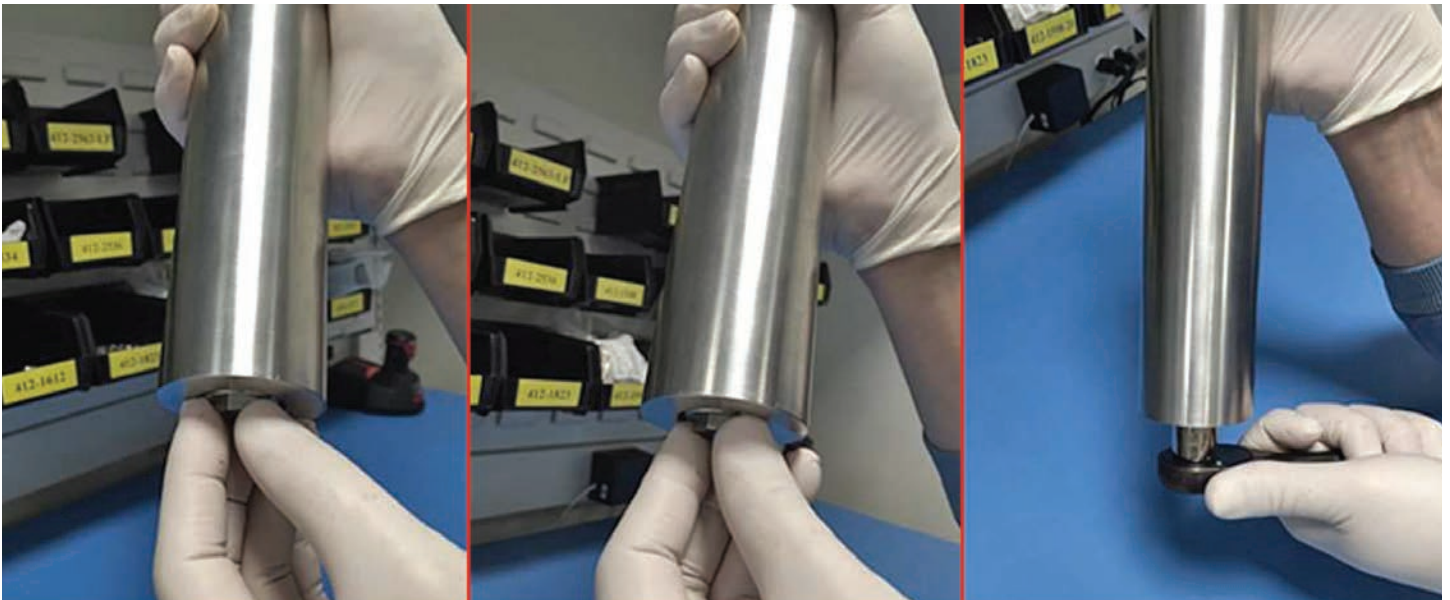

Figure 59: Replacing mirror end cap assembly into the absorption cell

19. As shown in *Figure 60*, the inner foam housing should be carefully reinserted into the Pelican case. When the foam assembly is properly inserted into the Pelican case, the front panel should be flush with the sides of the Pelican case.



Figure 60: Replacing inner foam housing into the External Pelican case after mirror cleaning

20. Re-establish power to the **Aurora TransPort** analyzer.
21. Re-establish the flow through the sample system.
22. If the **Aurora TransPort** still indicates a Check Mirror fault after normal start-up, contact Panametrics Technical Support for further assistance.

6.3 Replacing the filter element



Figure 61: Membrane filter

The **Aurora TransPort** uses a membrane filter (see *Figure 61* above) as the secondary filter. This filter is intended to prevent liquid or particulate contamination from entering the absorption cell. The Aurora should not be operated without a filter train upstream of the unit. The membrane filter is equipped with “Flow Block” which shuts off the flow if the filter element is heavily loaded with contamination.

A spring loaded check valve closes the outlet flow of the sample if the differential pressure across the filter element exceeds a threshold limit. At any given time the flow through the **Aurora TransPort** can be checked by observing the rotameter. If the “flow block” feature shuts off the flow, do not increase the pressure. Replace the filter element and clean the filter.

If the flow is being shut off too frequently, additional sample condition schemes, or the combination of the following, will have to be employed:

- **Bypass flow** - needed to sweep liquids or contamination off the filter. A 10:1 bypass flow rate should be maintained.
- Additional upstream filtration
- **Heat** - Heat tracing of the sample line and sample system components, sufficiently above both the water and hydrocarbon dew point, will keep the sample in the gas phase.

To replace the filter element, complete the following steps:

1. Close the inlet isolation needle valve and allow the system to fully depressurize.
2. Turn the filter cap counter-clockwise (see *Figure 62* below). You might need to use a channel-lock wrench to assist in loosening the cap.

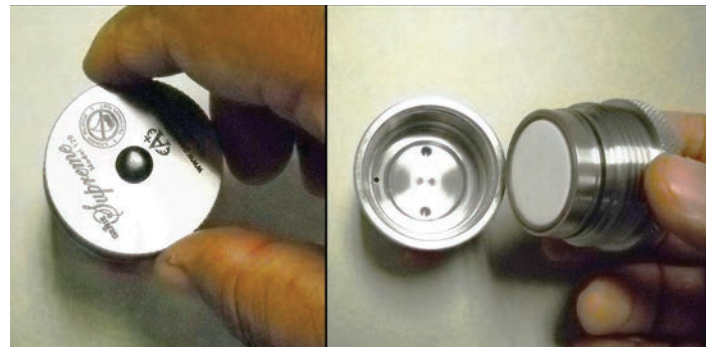

Figure 62: Removing the filter cap

3. Place the filter cap on a horizontal flat surface, filter side up.
4. Carefully remove the large O-ring (see *Figure 63* below).

Note: Because the O-rings are reused, replacement O-rings are not included in the maintenance kit.



Figure 63: Orient the filter cap and remove the large O-Ring

5. Remove the white membrane filter element and the membrane backing plate (see *Figure 64* below).



Figure 64: Remove the white filter element and the backing plate

6. Remove the small O-ring (see *Figure 65* below).



Figure 65: Remove the small O-ring

7. Using a tissue, clean the filter components (see *Figure 66* below).

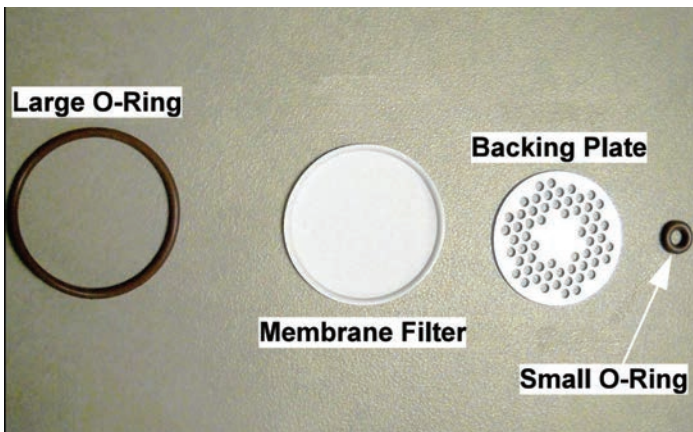

Figure 66: O-Rings, membrane filter and backing plate removed

8. Re-assemble the filter, and reinstall the cap hand-tight

Chapter 7. TransPort Troubleshooting

7.1 Introduction

The following are possible **Aurora TransPort** analyzer conditions with details on how to deal with them.

7.2 Blank display

1. Is the green POWER LED lit?
 - a. Yes - proceed to **Step 2**.
 - b. No - Check the wiring and the fuse
2. Are the four arrow keys illuminated?
 - a. Yes - If the keys remain illuminated for more than 12 seconds, the Boot Loader cannot find a valid Instrument Program to run.
 - b. No - contact the factory for service.

7.3 Display dim or hard to read

1. Adjust the LCD contrast using the Display/Adjust menu.

7.4 Status messages and indicators

The **Aurora TransPort** categorizes status messages as either Faults, Warnings, or Information. Status messages are displayed in the upper right corner of the display, with continuous scrolling from right to left for long messages.

- A **fault** is a non-recoverable condition that can affect the quality of measurement by the **Aurora TransPort**. Fault messages are accompanied by a slow flashing(!) indicator.
- A **warning** is a recoverable condition that can affect the quality of measurement by the **Aurora TransPort**. Warning messages are accompanied by a rapid flashing(!) indicator.
- **Information** messages alert the operator to a condition that is abnormal, but does not affect the quality of measurements. Information messages are accompanied by a slow flashing (i) indicator.

Aurora TransPort fault and status messages are prioritized. In case of more than one fault/status condition, the condition with the highest priority is displayed. When that condition is resolved, the next highest priority condition is displayed.

The possible status messages and indicators are summarized in *Table 4* below.

Table 4: Status messages and indicators		
Message	Condition	Description
Status OK	Info	Aurora TransPort is operating normally, no faults or other indications.
No CH4 detected	Info	Aurora TransPort is reading moisture, but cannot detect the presence of methane.
H2O Under Range	Info	The moisture level is below the system detection limits.
Warning - System Overheating	Fault	The temperature inside the electronics module exceeds 85°C or the air temperature inside the sample system enclosure exceeds 68°C. The laser is powered off until the electronics module temperature is below 80°C, and the sample system enclosure temperature is below 65°C.
FAULT: Temperature	Fault	The temperature transducer is operating out of limits, is disconnected, or has failed.
FAULT: Sample Pressure	Fault	The internal (sample) pressure transducer is operating out of limits, is disconnected, or has failed.
Laser Temp Unstable ...	Warning	The temperature of the laser is not stable. This warning occurs briefly at power on, as the Aurora TransPort sets the correct operating temperature. The laser is powered off until the temperature has stabilized.
Laser Adjust at Limits	Info	Aurora TransPort has reached the limit for adjusting the laser power. Contact the factory for assistance.
Laser Reference Fail	Fault	Aurora TransPort could not detect any signal from the laser. Contact the factory for assistance.
Weak Signal Return - Check Mirror	Info	Aurora TransPort could not detect a signal returned from the sample cell, or the signal is below allowed limits. Check mirror for contamination.
FAULT: TEC FAIL	Fault	Aurora TransPort has detected a failure in the laser temperature control. Contact the factory for assistance.
WARNING - Sample Pressure TOO HIGH	Warning	The pressure in the Aurora TransPort sample cell is greater than 212 kPa (30.75 psia). Verify regulator and flow settings; check for blocked vent line or excessive back pressure.
ERROR: TEC Setpoint out of Range	Fault	The Aurora TransPort temperature controller is was set beyond its operating limits. Contact the factory for assistance.
Service Req: ###	Fault	Aurora TransPort has detected a fault condition that has no associated status message. Contact the factory for assistance.

7.5 No flow measurement indicated on Aurora TransPort measurement cell

- Check that the outlet of the Aurora TransPort is venting to atmospheric pressure.
- Ensure that the sample system valves are configured correctly.
- Check/Replace the filter element in the coalescing filter as described in Chapter 5: "Maintenance" on page 42.

[no content intended for this page]

Appendix A. TransPort MODBUS RTU/TCP communications

A.1 Introduction

The **Aurora TransPort** supports digital communications using the Modbus/RTU protocol, with 2-wire RS-485 or 3-wire RS-232C as the physical layer. Data rate can be specified at rates from 4800 to 115200 bits per second (bps), with selectable parity.

The **Aurora TransPort** supports the Modbus/TCP protocol as defined in: MODBUS Messaging on TCP/IP Implementation Guide VI.Ob.

Aurora TransPort has two physically separate communications ports. Both ports can be selected for either RS-232 or RS-485 operation, and Aurora TransPort can communicate with both ports simultaneously.

Note: **Aurora TransPort** supports the Modbus/RTU protocol as defined in:

MODBUS Application Protocol Specification, VI.Ib and MODBUS over Serial Line Specification and Implementation Guide VI.02.

Note: The above referenced specifications are available from the Modbus Organization at <http://modbus-ida.org>.

A.2 Modbus functions and data types

The Modbus functions supported by **Aurora TransPort** include:

- (0x03) Read Holding Registers
- (0x04) Read Input Registers
- (0x08) Diagnostics (Serial Line only) - only supports Echo subcommand
- (0x10) Write Multiple registers
- (0x11) Report Slave ID (Serial Line only)
- (0x2B/0x0E) Read Device Identification - only supports Basic Device Identification tags, which are:
 - VendorName
 - Product code
 - Revision number

Aurora TransPort supports data types of Integer and Double/Float. Integer data types are always four (4) bytes long and should be read with a request for two registers (two bytes per each register, two registers total) at the address. Double/Float data types provide eight (8) byte double precision data or four (4) byte single precision data, depending on how many registers are requested. Four registers are used for double data types, and two registers are used for single precision data types.

Aurora TransPort Modbus register addresses are zero-based. Certain Modbus master software and devices use one-based addressing. With such devices, simply add 1 to the register addresses in *Table 5* on *page 64* for correct operation.

A.3 Modbus registers

All registers denoted with a bullet(-) in the Read-Only column are read-only registers and should be read with the function “Read Input Registers.” All other registers can be read and written with “Read Holding Registers” or “Write Multiple Registers.”

Note: The Modbus Register Address map supported by **Aurora TransPort** is shown in *Table 5* below.

Table 5: Modbus register map						
Function	Parameter	Description	Range/State	Addr	Data type	Read only
System Status ¹	Status Register			0	Integer	.
	Status Register, Latched	Write 0 to clear		1000	Integer	
Display	Data/Plot	Select Plot or Data Display view	0 = Data View 1-60 = Plot view duration, in minutes	1010	Integer	
	Primary Units	Measurement unit to display	Reg. address of Meas.	1100	Integer	
	Primary Decimals	# of decimal places to display	Measurement dependent	1110	Integer	
	Alt 1 (Left) Units	Measurement unit to display	Reg. address of Meas.	1200	Integer	
	Alt 1 (Left) Decimals	# of decimal places to display	Measurement dependent	1210	Integer	
	Alt 2 (Right) Units	Measurement unit to display	Reg. address of Meas.	1300	Integer	
	Alt 2 (Right) Decimals	# of decimal places to display	Measurement dependent	1310	Integer	

Table 5: Modbus register map (cont.)

Function	Parameter	Description	Range/State	Addr	Data type	Read only
Analog Output	Output 1	Trim Sequence Start/ Resume Live Output ²		2100	Integer	
		Units	Reg. address of Meas.	2110	Integer	
		Type	0 = 4-20mA, 1 = 0-20mA	2120	Integer	
		Trim Reading Zero	3.0 ~ 5.2	2140	Double/Float	
		Trim Reading Span	10.0 ~ 22.2	2150	Double/Float	
		Upper of Value	-10000 ~ 10000	2160	Double/Float	
		Lower of Value	-10000 ~ 10000	2170	Double/Float	
		Test	% value of output, 0~ 100	2180	Double/Float	
	Output 2	Trim Sequence Start/ Resume Live Output ²		2200	Integer	
		Units	Reg. address of Meas.	2210	Integer	
		Type	0 = 4-20mA, 1 = 0-20mA	2220	Integer	
		Trim Reading Zero	3.0 ~ 5.2	2240	Double/Float	
		Trim Reading Span	10.0 ~ 22.2	2250	Double/Float	
		Upper of Value	-10000 ~ 10000	2260	Double/Float	
		Lower of Value	-10000 ~ 10000	2270	Double/Float	
		Test	% value of output, 0~ 100	2280	Double/Float	
	Output 3	Trim Sequence Start/ Resume Live Output ²		2300	Integer	
		Units	Reg. address of Meas.	2310	Integer	
		Type	0 = 4-20mA, 1 = 0-20mA	2320	Integer	
		Trim Reading Zero	3.0 ~ 5.2	2340	Double/Float	
		Trim Reading Span	10.0 ~ 22.2	2350	Double/Float	
		Upper of Value	-10000 ~ 10000	2360	Double/Float	
		Lower of Value	-10000 ~ 10000	2370	Double/Float	
		Test	% value of output, 0~100	2380	Double/Float	

Table 5: Modbus register map (cont.)

Function	Parameter	Description	Range/State	Addr	Data type	Read only
Alarm	All Alarm Status		0 - 7 (Bitfield)	3000	Integer	.
	Alarm 1	Status	0 = Not tripped, 1 = Tripped	3100	Integer	.
		Switch	0= OFF, 1 = ON	3110	Integer	
		Units	Reg. address of Meas.	3120	Integer	
		Type	Set Point = 0, In Band = 1, Out Band= 2	3130	Integer	
		Upper	Depends on unit type	3140	Double/Float	
		Lower	Depends on unit type	3150	Double/Float	
	Alarm 2	Status	0 = Not tripped, 1 = Tripped	3200	Integer	.
		Switch	0= OFF, 1 = ON	3210	Integer	
		Units	Reg. address of Meas.	3220	Integer	
		Type	Set Point = 0, In Band = 1, Out Band= 2	3230	Integer	
		Upper	Depends on unit type	3240	Double/Float	
		Lower	Depends on unit type	3250	Double/Float	
	Alarm 3	Status	0 = Not tripped, 1 = Tripped	3300	Integer	.
		Switch	0= OFF, 1 = ON	3310	Integer	
		Units	Reg. address of Meas.	3320	Integer	
		Type	Set Point = 0, In Band = 1, Out Band= 2	3330	Integer	
		Upper	Depends on unit type	3340	Double/Float	
Lower		Depends on unit type	3350	Double/Float		
Settings	Adjust	PPM Level offset adjust	-25.00 ~ +25.00	5210	Double/Float	
		Moisture reading average filter size	10 - 200 samples	5230	Integer	
	Clock	Hour	0-23	5410	Integer	
		Minutes	0-59	5420	Integer	
		Month	1-12	5430	Integer	
		Date	1-28/29/30/31	5440	Integer	
		Year	2000-2099	5450	Integer	
	External Pressure	Constant	0 - 70,000.00 kPa	5510	Double/Float	
		Pressure Source	Constant Value = 0, Remote Value = 2	5540	Integer	
Remote Pressure		0 - 70,000 kPa	5550	Double/Float		

Function	Parameter	Description	Range/State	Addr	Data type	Read only	
Device ID	System S/N	-----	-----	8100	8 Byte String	.	
	Laser S/N	-----	-----	8200	8 Byte String	.	
	Calibration Date	Month		1-12	8310	Integer	.
		Date	Depends on month		8320	Integer	.
		Year		2000~2100	8330	Integer	.
Measurements	System Up Time	MSDate	Uptime, in days	8400	Double/Float	.	
	Dew Point	Dew Point °C		-----		Double/Float	.
		Dew Point °F		-----		Double/Float	.
		Equivalent Dew Point °C		-----		Double/Float	.
		Equivalent Dew Point °F		-----		Double/Float	.
		Equivalent Dew Point @ 70 Bar, °C		-----		Double/Float	.
	Temperature	Sample Temperature °C		-----		Double/Float	.
		Sample Temperature °F		-----		Double/Float	.
	External Pressure	kPa		-----		Double/Float	.
		MPa		-----		Double/Float	.
		PSia		-----		Double/Float	.
		PSig		-----		Double/Float	.
		kg/cm ²		-----		Double/Float	.
		Bars		-----		Double/Float	.
		mmHg		-----		Double/Float	.
	Internal Pressure	kPa		-----		Double/Float	.
		MPa		-----		Double/Float	.
		PSia		-----		Double/Float	.
		PSig		-----		Double/Float	.
		kg/cm ²		-----		Double/Float	.
		Bars		-----		Double/Float	.
		mmHg		-----		Double/Float	.
	H ₂ O Concentration	PPM		-----		Double/Float	.
		Lbs MMSCF		-----		Double/Float	.
		mg/sm ³		-----		Double/Float	.
		g/sm ³		-----		Double/Float	.
	Vapor Pressure	kPa		-----		Double/Float	.
		Flow Rate	Liters Per Minute (LPM)		-----		Double/Float
	Battery ³	Standard Cubic Feet Per Hour (SCFH)		-----		Double/Float	.
		Battery Temperature, °C		-----		Double/Float	.
		Battery Voltage		-----		Double/Float	.
		Battery Current, mA		-----		Double/Float	.
		Battery Charge, Percent		-----		Double/Float	.
		Battery Runtime Remaining, Minutes		-----		Double/Float	.

¹Address 0 is the System Status register, and address 1000 is the latching version of the System Status register. That is, both registers will show the error bit if the error is currently present, but only the latching register will show it if the condition is no longer present. Writing 0 to the latching register will clear the error code it contains.

²The “Trim Sequence Start/Resume Live Output” registers for the three outputs, (address 2100, 2200, 2300) accept certain values through the Write Multiple Register to trim the output current:

1. Write 0 to 2x00 to select the normal mA output (proportional to measurement).
2. Write 1 to 2x00 to reset the mA output trim to factory defaults.
3. Write 2 to 2x00 to output the “zero” current (~4.000 mA) and accept a calibration value written to 2x40.
4. Write 3 to 2x00 to output the “span” current (~20.000 mA) and accept a calibration value written to 2x50.

Note: Attempting to write to Trim registers 2x40/2x50 without first writing to Trim State register 2x00 will fail with Modbus exception 4.

At the end of calibration, write 0 to 2x00 to make Aurora TransPort exit trim mode.

³If the **Aurora TransPort** is operating while connected to the charger, battery data is not available, and all Modbus data associated with the battery will return 0.0.

A.4 Modbus system status codes

Table 6 below lists the System Status codes and descriptions. It is possible for multiple status codes to be present. The hexadecimal values represent the bit set for a given condition.

Table 6: System status codes	
Status	Description
0x00000000	Aurora TransPort is operating normally, no faults or other indications.
0x00000008	Aurora TransPort is reading moisture, but cannot detect the presence of methane.
0x00000010	The moisture level is below the system detection limits.
0x00000020	The temperature inside the electronics module exceeds 85°C. The laser is powered off until the temperature drops below 80°C.
0x00000040	The temperature transducer is operating out of limits, is disconnected, or has failed.
0x00000080	The internal (sample) pressure transducer is operating out of limits, is disconnected, or has failed.
0x00000100	The external (line) pressure transmitter is operating out of limits, is disconnected, or has failed. Occurs if source of the line pressure measurement is set to “Live”, and no pressure transmitter is attached.
0x00000200	Power supply under voltage
0x00000400	System ground fault
0x00000800	The temperature of the laser is not stable. This warning occurs briefly at power on, as the Aurora TransPort sets the correct operating temperature. The laser is powered off until the temperature has stabilized.
0x00001000	Aurora TransPort has reached the limit for adjusting the signal gain. Contact the factory for assistance.
0x00002000	Aurora TransPort has reached the limit for adjusting the laser power. Contact the factory for assistance.
0x00004000	Aurora TransPort could not detect any signal from the laser. Contact the factory for assistance.
0x00008000	Aurora TransPort could not detect a signal returned from the sample cell, or the signal is below allowed limits. Check the mirror for contamination.
0x00010000	Aurora TransPort has detected a failure in the laser temperature control. Contact the factory for assistance.
0x00020000	The pressure in the Aurora TransPort sample cell is greater than 212 kPa (30.75 psia). Verify regulator and flow settings; check for blocked vent line or excessive back pressure.
0x00040000	The Aurora TransPort temperature controller was set beyond its operating limits. Contact the factory for assistance.
0xlyyyzzzz	Extended Error Code

Appendix B. Aurora TransPort Ethernet operation

B.1 Introduction

B.1.1 Connection to the Internet/WAN



WARNING!

The Ethernet option provided in the **Aurora TransPort** is designed for use on a limited-access Local Area Network (LAN) protected by a suitable firewall. It should not be operated if exposed to the Internet or other unmanaged Wide Area Network (WAN). Check with your network administrator to determine whether it is safe to connect the Aurora TransPort to your network infrastructure.

B.1.2 Default passwords



WARNING!

The Ethernet option in the **Aurora TransPort** is based on technology from Digi International Inc. It includes built-in HTTP (web) and Telnet servers to provide administrative access and control. As shipped from the factory, there are two accounts enabled, with default passwords assigned. These default passwords are public knowledge, and widely distributed.



WARNING!

It is **IMPERATIVE** that the default passwords be changed before placing the **Aurora TransPort** into service!

B.1.3 Open ports and services warning

Any networked device can compromise the security of the network. It is the users' responsibility to understand the potential risks of attaching a device to the network, and provide adequate protection via firewalls or other means.

The **Aurora TransPort** may use or expose the following ports and services to provide network communications:

Port 23	Telnet management interface for Digi Module, open by default
Port 68	UDP, DHCP, open
Port 80	HTTP management interface for Digi Module, open by default
Port 502	TCP and UDP, Modbus/TCP, open by default
Port 771	Digi RealPort TCP, closed by default
Port 2101	Digi RealPort UDP, closed by default
Port 2362	Digi ADDP (Advanced Device Discovery Protocol), UDP, open by default
Port 32773	UDP, RPC, open

B.1.4 Initial setup

Before proceeding with this appendix, refer to "Ethernet Settings" on page 24 and be sure that all of the setup instructions in that section of been completed.

B.2 Device discovery

If no DHCP server is present on the LAN, Device Discovery will still allow you to identify the Aurora TransPort, and begin the configuration process. Confirm the Media Access Control (MAC) address displayed with the MAC address label on the Aurora TransPort Ethernet connector.

Note: You may now configure the Ethernet option via the Web or Telnet interface. The Web interface is simpler to operate than the Telnet interface, and is recommended in most circumstances.

Use the Open web interface option on the Device Tasks menu. The default web browser will launch and will display the Aurora TransPort login page shown in *Figure 67* below:

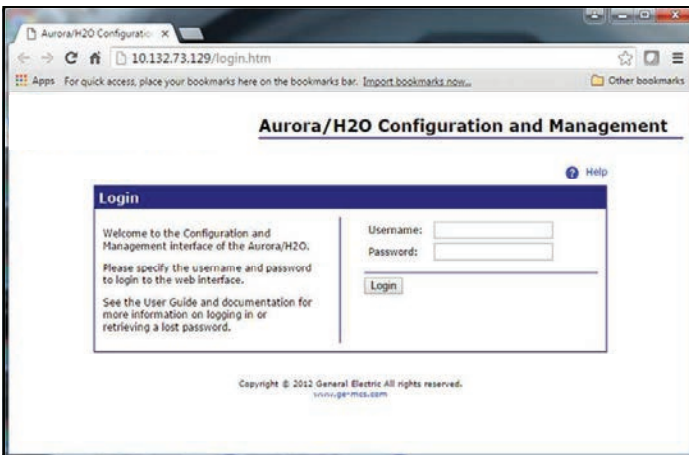

Figure 67: Web server - Login page

B.3 User accounts

As shipped, the Ethernet option supports two accounts:

- Root Account
- Operator Account

B.3.1 The root account

The root account allows complete configuration of the Ethernet option. This account should be used only by experienced network administrators. Misuse of the root account could prevent connection to the Aurora TransPort, or enable unauthorized access to the Aurora TransPort, or possibly expose the network to unauthorized users and exploits.

The default login credentials for the root account are:

- Username: root
- Password: dbps

Note: If the root password is lost, it is necessary to perform a Factory Reset of the Ethernet module (see "Connecting to an Ethernet LAN" on *page 24*).

Once logged in as a root account, the Home page will be displayed as shown in *Figure 68* below:

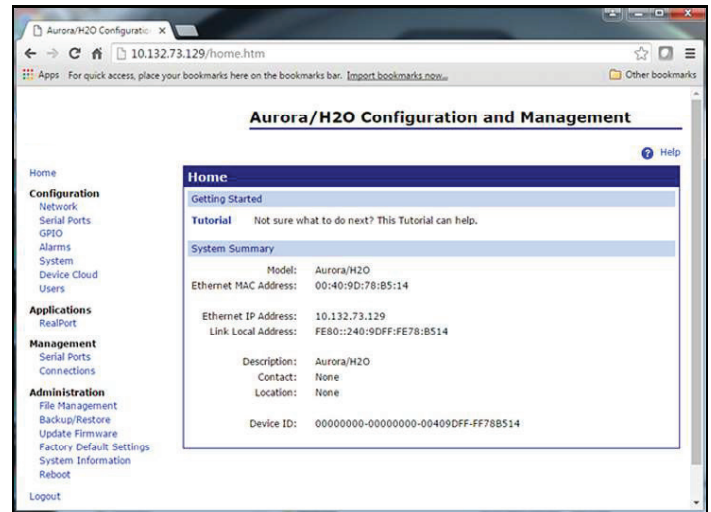

Figure 68: Web Server - Home page

The root password can be changed via the Users menu under Configuration, as shown in *Figure 69* below:

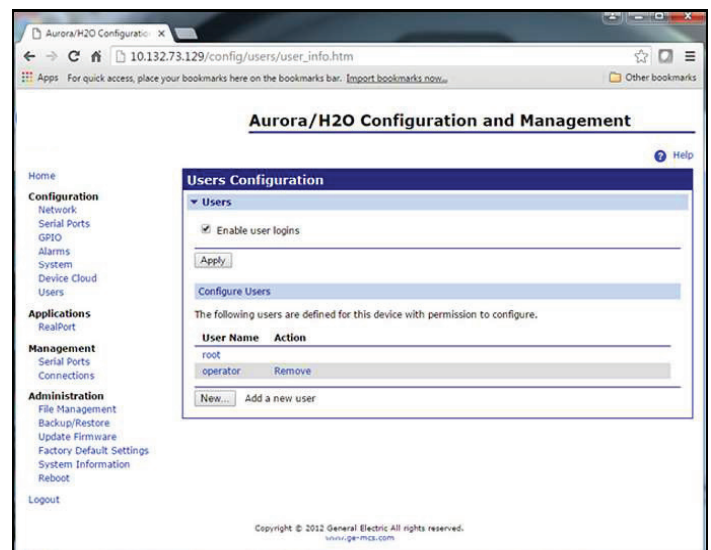

Figure 69: Web Server - User configuration page

Click on the root link to enter and confirm a new password for the root account:



WARNING!

Record the new root password immediately, and keep it in a safe and secure location!



WARNING!

It is NOT POSSIBLE to obtain a lost/forgotten root password! Resetting the root password requires a Factory Reset of the Ethernet module (see *Section 4.2.3* on *page 24*).

Enter the new password. Then, re-enter the password for confirmation and click Apply (see *Figure 70* below). The password will be changed immediately.

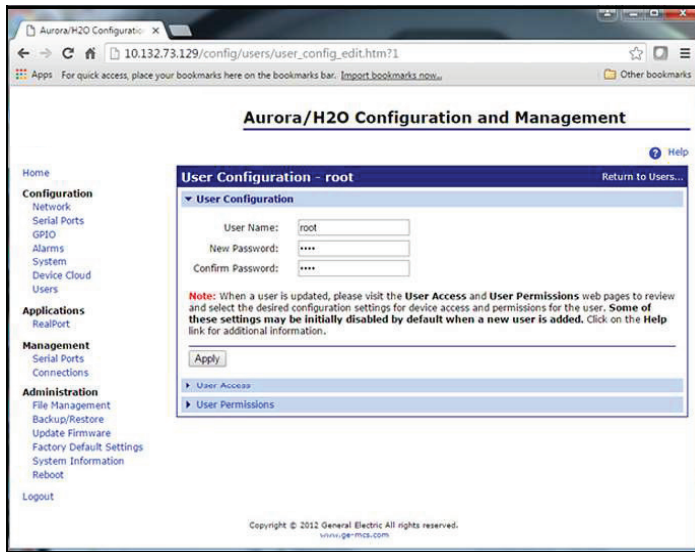

Figure 70: Web Server - Changing a password



WARNING!

Record the new root password immediately, and keep it in a safe and secure location!

B.3.2 The operator account

The operator account is provided to perform limited configuration management of the Aurora TransPort Ethernet option. The operator account has a reduced set of options, permissions, and capabilities. It is designed for use by field personnel performing commissioning or service of the Aurora TransPort.

The operator account allows the user to:

- Enable/Disable DHCP
- Specify a static IP, subnet, and gateway IP address
- Modify some of the serial protocol settings
- View the serial port connection status
- View the TCP/IP connection status
- View the Ethernet option firmware version, serial port and network diagnostics

The default login credentials for the operator account are:

- Username: operator
- Password: operator

The operator password should be changed at the earliest opportunity. Only the root account has permission to change the operator password. The steps for changing the operator password are the same as for changing the root password (see *“The Root Account”* on page 70). Select the operator account from the user configuration screen (see *Figure 69* on page 70), then enter and confirm the new password.



WARNING!

Record the new operator password immediately, and keep it in a safe and secure location!

Note: If the operator password is lost, it can always be reset using the root account.

Please note that the root account can also create other types of accounts, with different privilege levels. This is not recommended, and should only be performed by experienced operations personnel. Panametrics Oil and Gas can only assist with the use of root and operator accounts.

B.4 Communicating by MODBUS via Ethernet

The Aurora TransPort Ethernet option supports two communications modes:

- MODBUS/TCP over Ethernet
- MODBUS/RTU over Ethernet

The Aurora TransPort and the Ethernet option must be correctly configured for the desired communications mode.

B.4.1 MODBUS/TCP

Note: As shipped, the Aurora TransPort is configured to use the Modbus/TCP Ethernet protocol.

Select MODBUS/TCP (MB/TCP) from the Aurora TransPort menu (Main Menu, Settings... Ethernet..., Protocol).



To use Modbus/TCP over Ethernet, the Ethernet module must also be configured as follows:

1. Log in to the web user interface. Either the root account or an operator account may be used to configure the module.
2. Choose Serial Ports from the Configuration Menu. Verify that Industrial Automation is selected as the Profile (see *Figure 71* below).
3. Click on the Port 1 link to display the current Profile.

Serial Port Configuration			
Port	Description	Profile	Serial Configuration
Port 1	High Speed UART 2	Industrial Automation	230400 8N1

Figure 71: MB/TCP Serial port 1 profile

4. If the information displayed is not correct, change the profile as required.

B.4.2 MODBUS/RTU

To change the default MB/TCP Ethernet protocol and use the MB/RTU protocol instead, follow the instructions in this section.

Select MODBUS/RTU {MB/RTU} from the Aurora TransPort menu (Main Menu, Settings..., Ethernet..., Protocol).



To use Modbus/RTU over Ethernet, the Ethernet module must also be configured as follows:

1. Log in to the web user interface. Either the root account or an operator account may be used to configure the module.
2. Choose Serial Ports from the Configuration Menu. Verify that RealPort is selected as the Profile (see Figure 72 below).
3. Click on the Port 1 link to display the current Profile

Serial Port Configuration			
Port	Description	Profile	Serial Configuration
Port 1	High Speed UART 2	RealPort	N/A

Figure 72: MB/RTU Serial port 1 profile

4. If the information displayed is not correct, change the profile as required.

B.5 Using TELNET for configuration

If a web browser is not available or not practical in a given situation, the Telnet server can be used to perform configuration changes. Telnet is a text-based system that provides a Command Line Interface (CLI) to the Ethernet module. Microsoft Windows provides a Telnet client, or terminal emulators such as PuTTY or Tera Term can be used.

Note: Starting with Windows 7, the Telnet client is disabled by default.

To enable Telnet command line utilities, proceed as follows:

1. Click Start > Control Panel.
2. Click Programs and Features.
3. Click Turn Windows features on or off.
4. In the Windows Features dialog box, check the Telnet Client check box (see Figure 73 below).
5. Click OK and the system installs the appropriate files. This will take a few seconds to a minute.

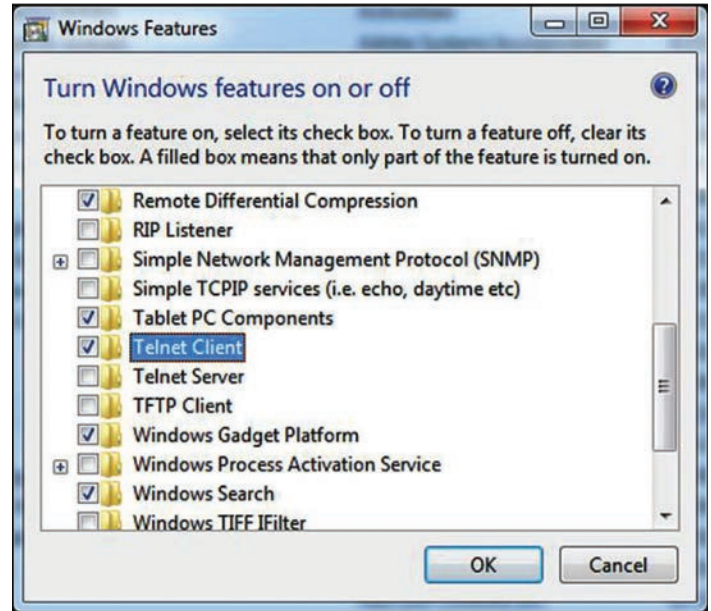

Figure 73: Windows features dialog box

B.6 Using the MS Windows Telnet client

1. At a Windows command prompt, enter telnet to run the Telnet client (see Figure 74 below).

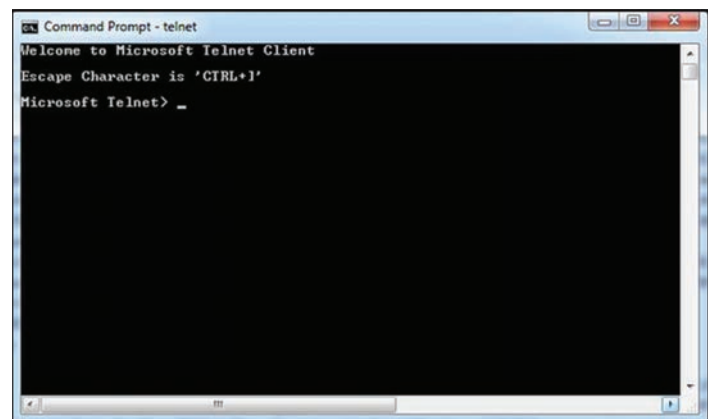

Figure 74: Telnet client

- To connect to the module, use the OPEN command with the IP address of the module (see *Figure 75* below).

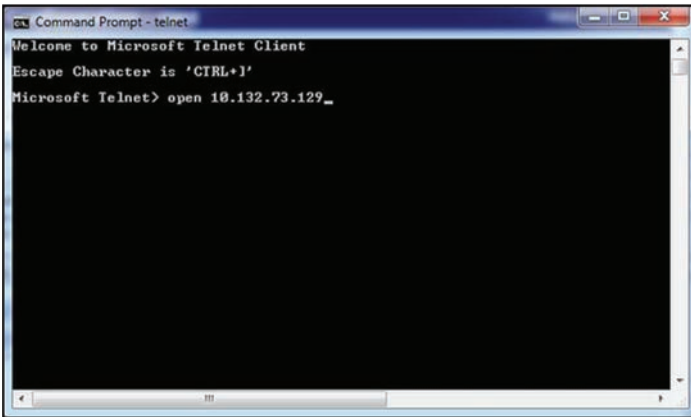

Figure 75: Telnet OPEN command

- At the module login: prompt, log in using the root account. Your password will not be echoed back. Upon successful login, the #> module prompt is displayed (see *Figure 76* below).

Note: For security reasons, the operator account only supports the http (web) server, and cannot be used via telnet.

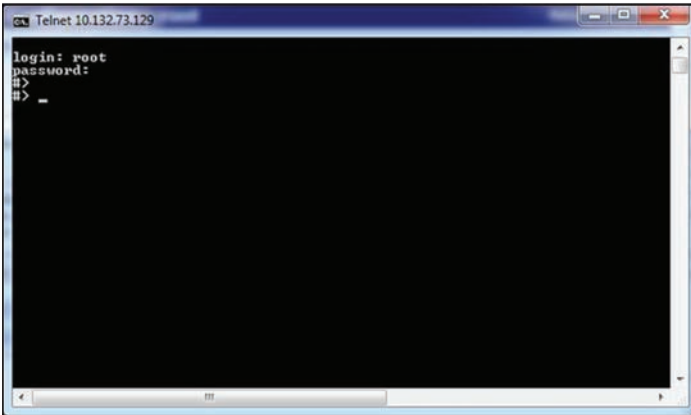

Figure 76: Telnet login

- Enter the set profile command to view the current setting (see *Figure 77* below). To change the profile, enter the command again and specify the profile desired:
 - set profile profile=realport (for Modbus/RTU), or
 - set profile profile=ia (for Modbus/TCP)

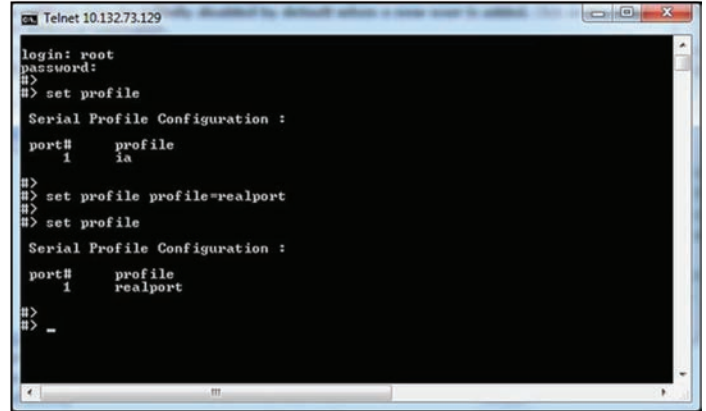

Figure 77: Telnet set profile command

- A list of other available commands and their usage can be displayed by entering help or ? at the #> prompt (see *Figure 78* below).
- To disconnect the telnet session, enter quit or exit. At the Microsoft Telnet> prompt, enter quit again to return to the Windows command prompt.

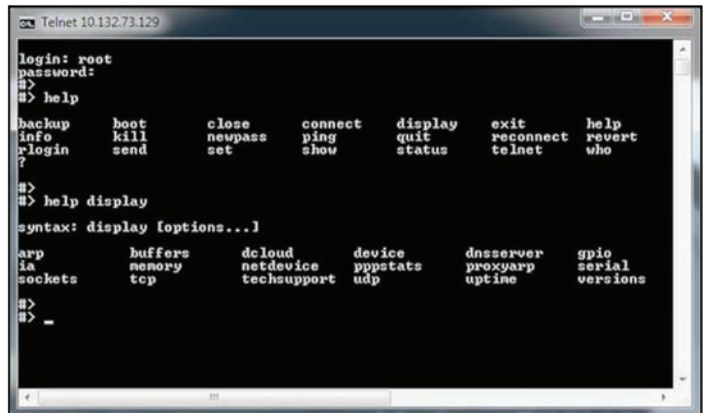

Figure 78: Telnet help command

[no content intended for this page]

Index

A

Aurora View	
Capabilities	52
Datalogging with	63
Installing	53
Requirements	52
Scan plots	64
Starting	36
Trend plots	58
Trend tabular data	64
Using main menus	64
Applications	
Blanketing gases in HC storage tanks	40
Formaldehyde reactor feed gases	42

B

Bill of materials	9
-------------------	---

C

Clock, Resetting	44
Comm port settings	35
Components	4
Connections	25

D

Default Display	28
Display	
Blank	77
Dim or Hard to Read	77
Locking/Unlocking	51
Setting Up	29
Display, Default	28

E

Electrical connections	20
------------------------	----

F

Features	1
Filter Element, Replacing	6

G

Gas molecular weight, Adjusting	42
---------------------------------	----

H

Heater	
EU/ATEX	3
USA/CAN	3

I

Indicator lights	28
Insertion Probe/Regulator	
Description	10
Installation	10
Setting the pressure	18
Installation	
Choosing a site	9
Mounting	10
Installation, System	9

K

Keypad	
Lock-out switch	28
Unlocking	28

L

Lights, Indicator	28
Low voltage directive	10

M

Magnetic stylus	28
Maintenance	69
Menu map	39
Menus, Accessing	68
Mirror, Cleaning	68
Modbus	
Register map	12
RTU/RS485 communications	12
Mounting	68

N

Numeric values, Entering	39
--------------------------	----

O

Offset values, Adjusting	66
Operation	
Sample system.....	12
Theory of	12
Outline.....	66

P

Parts	39
Parts list.....	68
Pressure settings, Resetting.....	23
Programming	
Advanced Features	12
General.....	12
Menu map.....	12

R

Regional settings	82
Registration.....	69
Replacing the filter element	66

S

Safety	
Auxiliary equipment.....	12
General issues.....	12
Personal equipment.....	12
Sample system	
Operation	12
Services.....	39
Settings, Regional.....	68
Site location	23
Spare parts	39
Specifications.....	68
Starting up.....	23
Stylus, Magnetic	23
System	
Information.....	12

T

Troubleshooting	23
Blank display	12
Display dim or hard to read	62
No flow measurement.....	12
Status messages and indicators.....	17
Using a moisture standard.....	72
Using a portable Hygrometer	17
Verifying performance	12
Typographical conventions.....	23

U

Unpacking	23
-----------------	----

W

Wiring.....	23
Wiring diagram	
EU/ATEX heater	12
USA/CAN heater	12

Warranty

Each instrument manufactured by Panametrics Sensing is warranted to be free from defects in material and workmanship. Liability under this warranty is limited to restoring the instrument to normal operation or replacing the instrument, at the sole discretion of Panametrics Sensing. Fuses and batteries are specifically excluded from any liability. This warranty is effective from the date of delivery to the original purchaser. If Panametrics Sensing determines that the equipment was defective, the warranty period is:

- 18 Months from delivery for electronic or mechanical failures
- 18 Months from delivery for sensor shelf life

If Panametrics Sensing determines that the equipment was damaged by misuse, improper installation, the use of unauthorized replacement parts, or operating conditions outside the guidelines specified by Panametrics Sensing, the repairs are not covered under this warranty.

The warranties set forth herein are exclusive and are in lieu of all other warranties whether statutory, express or implied (including warranties or merchantability and fitness for a particular purpose, and warranties arising from course of dealing or usage or trade).

Return policy

If a Panametrics Sensing instrument malfunctions within the warranty period, the following procedure must be completed:

1. Notify Panametrics Sensing, giving full details of the problem, and provide the model number and serial number of the instrument. If the nature of the problem indicates the need for factory service, Panametrics Sensing will issue a RETURN AUTHORIZATION NUMBER (RAN), and shipping instructions for the return of the instrument to a service center will be provided.
2. If Panametrics Sensing instructs you to send your instrument to a service center, it must be shipped prepaid to the authorized repair station indicated in the shipping instructions.
3. Upon receipt, Panametrics Sensing will evaluate the instrument to determine the cause of the malfunction.

Then, one of the following courses of action will then be taken:

- If the damage is covered under the terms of the warranty, the instrument will be repaired at no cost to the owner and returned.
- If Panametrics Sensing determines that the damage is not covered under the terms of the warranty, or if the warranty has expired, an estimate for the cost of the repairs at standard rates will be provided. Upon receipt of the owner's approval to proceed, the instrument will be repaired and returned.

Customer support centers

Americas

U.S.A.

The Boston Center
1100 Technology Park Drive
Billerica, MA 01821
U.S.A.
Tel: +1 800 833 9438 (toll-free)
Tel: +1 978 437 1000
E-mail: mstechsupport@bhge.com

Europe

Ireland

Sensing House
Shannon Free Zone East
Shannon, County Clare
Ireland
Tel: +353 61 61470200
E-mail: mstechsupport@bhge.com

Panametrics, a Baker Hughes Business, provides solutions in the toughest applications and environments for moisture, oxygen, liquid and gas flow measurement. Experts in flare management, Panametrics technology also reduces flare emissions and optimizes performance.

With a reach that extends across the globe, Panametrics' critical measurement solutions and flare emissions management are enabling customers to drive efficiency and achieve carbon reduction targets across critical industries including: Oil and Gas; Energy; Healthcare; Water and Wastewater; Chemical Processing; Food and Beverage and many others.

Join the conversation and follow us on LinkedIn

<https://www.linkedin.com/company/panametricscompany>